



# Collection

boss

January 2023

[www.bosdesign.com/us](http://www.bosdesign.com/us)



# Pricelist

---

## US Collection 22/23

Beautiful, innovative products to build  
inspirational spaces for people and places.



Scan or click on the QR codes featured throughout  
this price list to find out more about the product.

# Collections

## boss



01  
Sofa Collections



02  
Chairs & Stools



03  
Modular Seating Systems



04  
Focus Booths



05  
Task Chairs



06  
Media Units

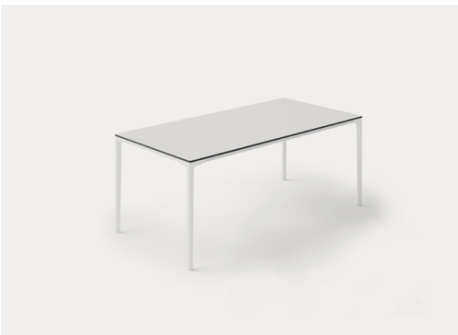

07  
Tables



08  
Storage



09  
Pods

<b>Sofa Collections</b>	<b>17</b>	<b>Modular Seating</b>	<b>223</b>	<b>Storage</b>	<b>445</b>
Alexa	18	Arthur CityScape	224	Credenzas	446
Albany	20	Atom	234	<b>Pods</b>	<b>463</b>
Arlington	24	Hemm	244	Scene	464
Arthur	26	Imogen	256	Qube	474
Bodie	32	Myriad	262	Telephone Pods	480
Clarence	36	Raft	278	<b>Cartwright</b>	<b>487</b>
Fairfax	38	Raft Plus	282	20/123 Series	488
Flo	42	<b>Focus Booths</b>	<b>289</b>	180 Series	490
Layla	46	Cega	290	Aldo	494
Lexe	50	Cocoon	292	Buff	496
Manta	52	Entente	294	Clancy	500
Maysa	56	Mango	302	Greg	504
Olivia	64	Peek & Boo	306	Kelly	506
Orten	68	Shuffle	310	Logan	510
Orten Modular	72	Snug	312	Maestro	512
Orten Wide Arm	78	<b>Task Chairs</b>	<b>317</b>	O'Brien	516
Vernon	80	Coza	318	Sassi	520
<b>Chairs &amp; Stools</b>	<b>83</b>	Delphi	322	<b>Appendix</b>	<b>523</b>
Agent	84	Tauro	326	Power & Data	524
Amelia	90	Trinetic	330	Seating Timber Finishes & Stains	534
Arran	98	<b>Media Units</b>	<b>335</b>	Metal & Plastic Finishes	535
Brimm	104	Cocoon Media	336	Table Top & Credenza Finishes	536
Callisto	106	Portal	338	Graded-In Textiles	539
DNA	112	<b>Tables</b>	<b>341</b>	Boss Design Textiles	540
Happy	118	ACDC	342	Upholstery Options	541
Hoot	120	Agent	354	Wood Painted Frames	542
Isla	122	Atom	374	Ordering Instructions	544
Jolly	128	Axis	380	Terms & Conditions	546
Kruze	130	Deploy	382	Notes	550
Kruze Lounge	140	Flamingo	390		
Kruze Lounge Plush	146	Indi	392		
Luge	148	Isla	398		
Magic	152	Kruze	400		
Marnie	154	Layla	402		
Mars	160	Line	404		
Mr & Mrs	164	Magic	406		
Nevez	168	Metro	408		
Ola	174	Niko	414		
Paloma	186	Pause, Wait & Us	420		
Pro	196	Pegasus	422		
Rosa	200	Reef	430		
Saint	204	Sol	438		
Tokyo	212	Triad	442		
Toto	216				



# Design

---

British Heritage - US Production

Our Collection, stands for design integrity, detail and superior quality. Boss Design products are at the cutting edge of design and feature first class engineering and workmanship, extensive tooled investment and incorporate only the finest materials and components.

We have always invested in design. Our established in-house team comprised of designers and engineers working closely together, means we can shape the design processes all the way from initial idea to the final product, with a holistic and collaborative approach to sustainable product development.

Boss Design is revered the world over for its pioneering developments and staunch ethical standards. We are proud of our commitment to design and manufacturing excellence.









# Modern

---

Tradition

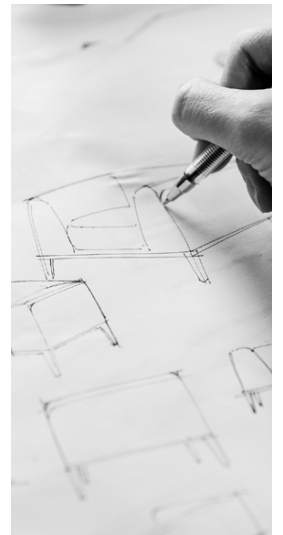





# Develop

---

Made Sustainably

We believe in products that are built to last. It makes sense for us and it makes sense for the planet. We have a responsibility to limit the impact on the environment ensuring our products stay relevant and we use responsible, quality materials that will withstand the test of time.



# Deliver

---

## Responsible Manufacturing

Boss operate across five continents, with four strategic production facilities located in the UK, North America, the Middle East, and the Far East, offering in excess of 150 product ranges. Each with the same commitment to sustainably manufactured, quality products.

We measure, monitor and control all our CO2 emissions across the business, from road and air miles to the carbon footprint of our products. We are working to become a truly Carbon Neutral manufacturer to minimize our impact on the environment for future generations.

Our VOC certification confirms that we manufacture low-emitting furniture in-line with LEED, BREEAM, Well Building Standard and Healthy Hospitals Initiative. Our efforts have been rewarded with the Gold International Standards from BIFMA.ANSI/BIFMA M71



### End to End

Our partners, Waste to Wonder, enable us to divert thousands of tons of equipment from landfill and equip hundreds of schools and good causes in 18 countries with office equipment. We are always looking for new and innovative ways to reduce our carbon footprint in a sustainable, efficient and socially beneficial way.

### Waste

Our lean manufacturing process means we have zero waste to landfill across our facilities. All our waste materials are either reused internally or through our local social schemes, with anything that can't be reused, being recycled.

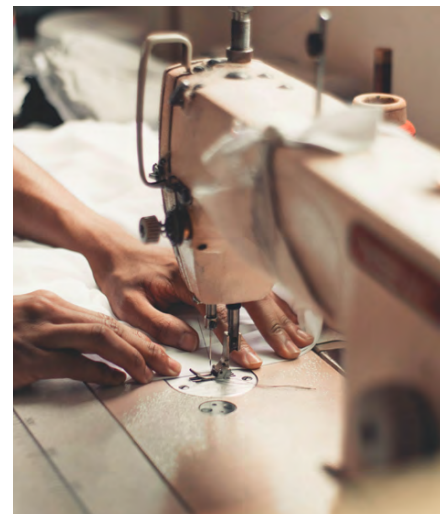
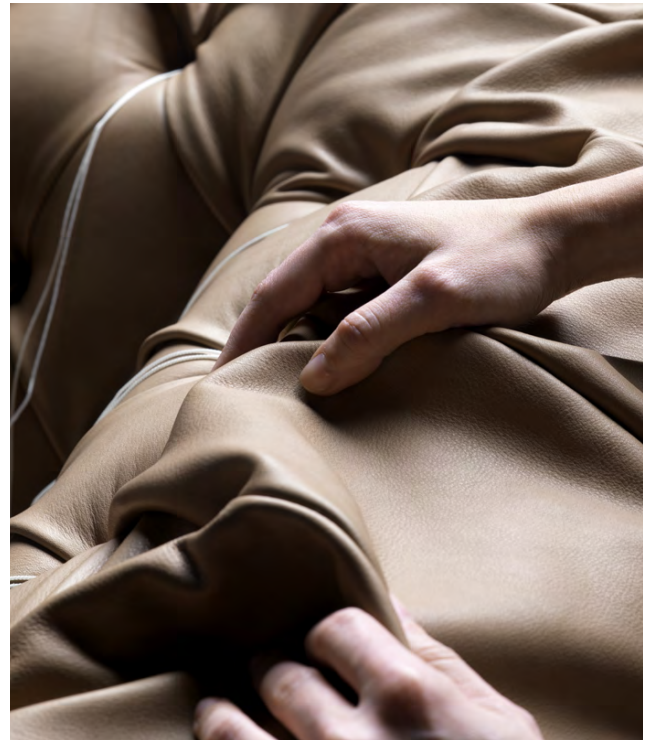



**01.**





**Sofa  
Collections**







## Range Information

- Fully upholstered in fabric or leather
- Hardwood internal frame
- Sprung seat and back
- Multi density CMHR polyurethane foam
- Twin needle stitch detail
- Folded steel leg frame
- Black and Bronze metal finish as standard
- Other Leg colors POA
- Range includes an armchair, two seater and three-seater sofa
- Not recommended to be upholstered in Grade 1 fabrics







<b>ALE/1 ARMCHAIR</b>	<b>Code:</b>	<b>Description</b>	<b>COM</b>	<b>1</b>	<b>2</b>	<b>3</b>	<b>4</b>	<b>5</b>	<b>6</b>	<b>7</b>	<b>8</b>	<b>9</b>	<b>10</b>	<b>COL</b>	<b>L1</b>	<b>L2</b>	<b>L3</b>				
	<b>ALE/1</b>	Fully upholstered armchair, powder coated steel base	3388	3564	3774	3914	4160	4336	4652	5002	5458	5878	3600	5554	6750	10404	7	126			

**DIMENSIONS**  
 Height: **750mm (30")**  
 Width: **800mm (32")**  
 Depth: **770mm (30")**  
 Seat Height: **425mm (17")**  
 Arm Height: **580mm (23")**

<b>ALE/2 TWO SEAT SOFA</b>	<b>Code:</b>	<b>Description</b>	<b>COM</b>	<b>1</b>	<b>2</b>	<b>3</b>	<b>4</b>	<b>5</b>	<b>6</b>	<b>7</b>	<b>8</b>	<b>9</b>	<b>10</b>	<b>COL</b>	<b>L1</b>	<b>L2</b>	<b>L3</b>				
	<b>ALE/2</b>	Fully upholstered 2 seat sofa, powder coated steel base	4920	5220	5580	5820	6240	6540	7080	7680	8460	9180	5274	8622	10674	16938	12	216			

**DIMENSIONS**  
 Height: **750mm (30")**  
 Width: **1385mm (55")**  
 Depth: **770mm (30")**  
 Seat Height: **425mm (17")**  
 Arm Height: **580mm (23")**

LOUNGE SEATING

<b>ALE/3 THREE SEAT SOFA</b>	<b>Code:</b>	<b>Description</b>	<b>COM</b>	<b>1</b>	<b>2</b>	<b>3</b>	<b>4</b>	<b>5</b>	<b>6</b>	<b>7</b>	<b>8</b>	<b>9</b>	<b>10</b>	<b>COL</b>	<b>L1</b>	<b>L2</b>	<b>L3</b>				
	<b>ALE/3</b>	Fully upholstered 3 seat sofa, powder coated steel base	6110	6560	7100	7460	8090	8540	9350	10250	11420	12500	6626	11648	14726	24122	18	324			

**DIMENSIONS**  
 Height: **750mm (30")**  
 Width: **2000mm (79")**  
 Depth: **770mm (30")**  
 Seat Height: **425mm (17")**  
 Arm Height: **580mm (23")**

N.B. Leather is a natural material which will crease and 'puddle'.

 Fabric Linear Yard  Leather Square Footage  Product Weight

# Albany

Lounge Seating

boss











Classic elegance and quality are the hallmarks of Albany's buttoned-backed armchairs and sofas. Our master upholsterers ensure that each Albany piece is meticulously finished by hand from the finest sustainable





materials. The frame is crafted in Oak or American Black Walnut and for even greater impact, pair alongside one of Albany's understated oak and walnut veneered tables.



LOUNGE SEATING

<b>ALBANY ARMCHAIR</b>		<b>Code:</b>	<b>Description</b>	<b>COL</b>	<b>2</b>	<b>3</b>	<b>4</b>	<b>5</b>	<b>6</b>	<b>7</b>	<b>8</b>	<b>9</b>	<b>10</b>	<b>COL</b>	<b>L1</b>	<b>L2</b>	<b>L3</b>			
				<b>/1</b>														(ly)	(ft <sup>2</sup> )	(lb)
 <p><b>DIMENSIONS</b>            Height: <b>800mm (31")</b>            Width: <b>690mm (27")</b>            Depth: <b>690mm (27")</b>            Seat Height: <b>410mm (16.25")</b>            Arm Height: <b>600mm (25.5")</b></p>	<b>ALB/1/ OAK</b>	Armchair with Oak legs (As Shown)	1942	2042	2162	2242	2382	2482	2662	2862	3122	3362	2064	3180	3864	5952		4	72	
	<b>ALB/1/ ABW</b>	Armchair with ABW legs	2080	2180	2300	2380	2520	2620	2800	3000	3260	3500	2202	3318	4002	6090		4	72	

<b>ALBANY COMPACT SOFA</b>		<b>Code:</b>	<b>Description</b>	<b>COL</b>	<b>2</b>	<b>3</b>	<b>4</b>	<b>5</b>	<b>6</b>	<b>7</b>	<b>8</b>	<b>9</b>	<b>10</b>	<b>COL</b>	<b>L1</b>	<b>L2</b>	<b>L3</b>			
				<b>/1</b>														(ly)	(ft <sup>2</sup> )	(lb)
 <p><b>DIMENSIONS</b>            Height: <b>850mm (33")</b>            Width: <b>1165mm (46")</b>            Depth: <b>715mm (28")</b>            Seat Height: <b>410mm (16.25")</b>            Arm Height: <b>600mm (25.5")</b></p>	<b>ALB/2/ OAK</b>	Compact Sofa with Oak legs (As Shown)	2766	2892	3042	3142	3318	3444	3670	3920	4246	4546	2922	4318	5172	7782		5	90	
	<b>ALB/2/ ABW</b>	Compact Sofa with ABW legs	2856	2982	3132	3232	3408	3534	3760	4010	4336	4636	3012	4408	5262	7872		5	90	

<b>ALBANY LARGE SOFA</b>		<b>Code:</b>	<b>Description</b>	<b>COL</b>	<b>2</b>	<b>3</b>	<b>4</b>	<b>5</b>	<b>6</b>	<b>7</b>	<b>8</b>	<b>9</b>	<b>10</b>	<b>COL</b>	<b>L1</b>	<b>L2</b>	<b>L3</b>			
				<b>/1</b>														(ly)	(ft <sup>2</sup> )	(lb)
 <p><b>DIMENSIONS</b>            Height: <b>850mm (33")</b>            Width: <b>1415mm (56")</b>            Depth: <b>715mm (28")</b>            Seat Height: <b>410mm (16.25")</b>            Arm Height: <b>600mm (25.5")</b></p>	<b>ALB/3/ OAK</b>	Large Sofa with Oak legs (As Shown)	3466	3616	3796	3916	4126	4276	4546	4846	5236	5596	3654	5328	6354	9486		6	108	
	<b>ALB/3/ ABW</b>	Large Sofa with ABW legs	3652	3802	3982	4102	4312	4462	4732	5032	5422	5782	3842	5516	6542	9674		6	108	

N.B. Leather is a natural material which will crease and 'puddle'.  Fabric Linear Yard  Leather Square Footage  Product Weight

## Range Information

- Hardwood and plywood internal frame
- Fixed CMHR foam seat and back
- Webbed seat and back construction
- Top stitch detail
- Soft buttoning
- Timber Underframe available in Oak, American Black Walnut or to a painted finish (painted finish is \$236.)
- Finish: Clear lacquer
- Colored buttons available on request
- Not recommended to be upholstered in Grade 1 fabrics



<b>ALBANY DINING CHAIR</b>	<b>Code:</b>	<b>Description</b>	COL	2	3	4	5	6	7	8	9	10	COL	L1	L2	L3			
 <p><b>DIMENSIONS</b>                      Height: <b>850mm (33")</b>                      Width: <b>620mm (24")</b>                      Depth: <b>620mm (24")</b>                      Seat Height: <b>470mm (18.5")</b>                      Arm Height: <b>640mm (25.25")</b></p>	<b>ALB/4/OAK</b>	Dining chair with Oak legs (As Shown)	1788	1864	1954	2014	2120	2196	2332	2482	2678	2858	1884	2722	3234	4800	3	54	
	<b>ALB/4/ABW</b>	Dining chair with ABW legs	1968	2044	2134	2194	2300	2376	2512	2662	2858	3038	2066	2904	3416	4982	3	54	

LOUNGE SEATING

<b>ALBANY COFFEE TABLE</b>	<b>Code:</b>	<b>Description</b>	<b>\$</b>	
 <p><b>DIMENSIONS</b>                      Height: <b>360mm (14")</b>                      Width: <b>1165mm (46")</b>                      Depth: <b>715mm (28")</b></p>	<b>ALB/5/OAK</b>	Coffee table in Oak (As Shown)	1642	
	<b>ALB/5/ABW</b>	Coffee table in ABW	1802	

N.B. Leather is a natural material which will crease and 'puddle'.

Fabric Linear Yard Leather Square Footage Product Weight



## Range Information

- Range consists of armchair, two seat sofa and three seat sofa
- Fixed CMHR foam seat cushion
- CMHR foam cushioned back
- Deep buttoned with pleats
- Timber Underframe available in Oak, American Black Walnut or to a painted finish (painted finish is \$236)
- Not recommended to be upholstered in Grade 1 fabrics



**ARMCHAIR**

	Code:	Description	COL /1	2	3	4	5	6	7	8	9	10	COL	L1	L2	L3	(ly)	(ft <sup>2</sup> )	(lb)
 <p><b>DIMENSIONS</b>                      Height: <b>700mm (28")</b>                      Width: <b>910mm (36")</b>                      Depth: <b>780mm (31")</b>                      Seat Height: <b>400mm (16")</b></p>	<b>ARL/1</b>	Arlington armchair, Oak	3864	3978	4114	4204	4362	4476	4680	4906	5200	5470	4018	5274	6044	8392	4.50	81	
	<b>ARL/4</b>	Arlington armchair, American Black Walnut	3920	4034	4170	4260	4418	4532	4736	4962	5256	5526	4076	5332	6102	8450	4.50	81	

**TWO SEAT SOFA**

	Code:	Description	COL /1	2	3	4	5	6	7	8	9	10	COL	L1	L2	L3	(ly)	(ft <sup>2</sup> )	(lb)
 <p><b>DIMENSIONS</b>                      Height: <b>700mm (28")</b>                      Width: <b>1440mm (57")</b>                      Depth: <b>780mm (31")</b>                      Seat Height: <b>400mm (16")</b></p>	<b>ARL/2</b>	Arlington 2 seat sofa, Oak	5382	5520	5686	5796	5990	6128	6376	6652	7010	7340	5576	7112	8052	10922	5.50	99	
	<b>ARL/5</b>	Arlington 2 seat sofa, American Black Walnut	5466	5604	5770	5880	6074	6212	6460	6736	7094	7424	5662	7198	8138	11008	5.50	99	

**THREE SEAT SOFA**

	Code:	Description	COL /1	2	3	4	5	6	7	8	9	10	COL	L1	L2	L3	(ly)	(ft <sup>2</sup> )	(lb)
 <p><b>DIMENSIONS</b>                      Height: <b>700mm (28")</b>                      Width: <b>2060mm (81")</b>                      Depth: <b>780mm (31")</b>                      Seat Height: <b>400mm (16")</b></p>	<b>ARL/3</b>	Arlington 3 seat sofa, Oak	6480	6656	6866	7006	7252	7428	7744	8094	8550	8970	6724	8678	9874	13528	7.00	126	
	<b>ARL/6</b>	Arlington 3 seat sofa, American Black Walnut	6592	6768	6978	7118	7364	7540	7856	8206	8662	9082	6836	8790	9986	13640	7.00	126	

LOUNGE SEATING

N.B. Leather is a natural material which will crease and 'puddle'.

 Fabric Linear Yard  Leather Square Footage  Product Weight



# Arthur

Lounge Seating

boss



Arthur combines the soft, deep seat and clean refined lines with a highback element, allowing for the design to create private zones within bigger spaces and provide shelter for conversation and collaboration. Responsibly and sustainably sourced, Arthur's handcrafted hard wood

frame and timber underframe gives it its signature design. Available as a compact sofa, large sofa and single seater, Arthur is highly customizable thanks to its high or low back options and the choice of either plain or bump back upholstery



LOUNGE SEATING







## Range Information

- Hardwood and plywood internal frame
- CMHR foam and fibre seat cushion
- Foam and feather lumbar cushion
- CMHR fixed foam back
- Top stitch detail
- A full range of line drawings and images in the Arthur range can be downloaded from our website [bossdesign.com](http://bossdesign.com)
- Timber Underframe available in Oak, American Black Walnut or to a painted finish (painted finish is \$236)
- Not recommended to be upholstered in Grade 1 fabrics



ARMCHAIR 980H	Code:	Description	COM										(ly)	(lb)
			/1	2	3	4	5	6	7	8	9	10		
 <p><b>DIMENSIONS</b> Height: <b>980mm (39")</b> Width: <b>1020mm (40")</b> Depth: <b>780mm (31")</b> Seat Height: <b>420mm (16.5")</b> Seat Depth: <b>530mm (20.75")</b></p>	ART/1/OAK	Arthur Armchair Oak Underframe (As Shown)	4970	5264	5618	5854	6266	6560	7090	7678	8442	9148	7	
	ART/1/ABW	Arthur Armchair American Black Walnut	5034	5328	5682	5918	6330	6624	7154	7742	8506	9212	7	
	ART/4/OAK	Arthur Armchair Bumped back Oak Underframe	5216	5516	5876	6116	6536	6836	7376	7976	8756	9476	7	
	ART/4/ABW	Arthur Armchair Bumped back ABW Underframe	5280	5580	5940	6180	6600	6900	7440	8040	8820	9540	7	

COMPACT SOFA 980H	Code:	Description	COM										(ly)	(lb)
			/1	2	3	4	5	6	7	8	9	10		
 <p><b>DIMENSIONS</b> Height: <b>980mm (39")</b> Width: <b>2020mm (80")</b> Depth: <b>780mm (31")</b> Seat Height: <b>420mm (16.5")</b> Seat Depth: <b>530mm (20.75")</b></p>	ART/2/OAK	Arthur Compact Sofa Oak Underframe	5324	5624	5984	6224	6644	6944	7484	8084	8864	9584	11.75	
	ART/2/ABW	Arthur Compact Sofa American Black Walnut	5384	5684	6044	6284	6704	7004	7544	8144	8924	9644	11.75	-
	ART/5/OAK	Arthur Compact Sofa Bumped back Oak Underframe (As Shown)	5506	5814	6182	6428	6858	7166	7718	8332	9130	9866	12	
	ART/5/ABW	Arthur Compact Sofa Bumped back ABW Underframe	5568	5876	6244	6490	6920	7228	7780	8394	9192	9928	12	-

LARGE SOFA 980H	Code:	Description	COM										(ly)	(lb)
			/1	2	3	4	5	6	7	8	9	10		
 <p><b>DIMENSIONS</b> Height: <b>980mm (39")</b> Width: <b>2320mm (91")</b> Depth: <b>780mm (31")</b> Seat Height: <b>420mm (16.5")</b> Seat Depth: <b>530mm (20.75")</b></p>	ART/3/OAK	Arthur Large Sofa Oak Underframe (As Shown)	5324	5624	5984	6224	6644	6944	7484	8084	8864	9584	12	
	ART/3/ABW	Arthur Large Sofa American Black Walnut	5384	5684	6044	6284	6704	7004	7544	8144	8924	9644	12	-
	ART/6/OAK	Arthur Large Sofa Bumped back Oak Underframe	5506	5814	6182	6428	6858	7166	7718	8332	9130	9866	12.25	
	ART/6/ABW	Arthur Large Sofa Bumped back ABW Underframe	5568	5876	6244	6490	6920	7228	7780	8394	9192	9928	12.25	-

LOUNGE SEATING

**Options**

CODE:	DESCRIPTION	\$
-	Polished Aluminum Leg Set	116

**ARMCHAIR HIGH BACK  
1240H**



**DIMENSIONS**

Height: 1240mm (49")  
 Width: 1020mm (40")  
 Depth: 780mm (31")  
 Seat Height: 420mm (16.5")  
 Seat Depth: 530mm (20.75")

Code:	Description	COM /1	2	3	4	5	6	7	8	9	10	(ly)	(lb)
ART/7/OAK	Arthur Armchair High Back Oak Underframe (As Shown)	3354	3562	3810	3976	4266	4474	4846	5260	5798	6294	8.25	
ART/7/ABW	Arthur Armchair High Back American Black Walnut	3392	3600	3848	4014	4304	4512	4884	5298	5836	6332	8.25	-
ART/10/OAK	Arthur Armchair High Back Bumped back Oak Underframe	3488	3702	3958	4128	4426	4640	5024	5450	6004	6514	8.5	
ART/10/ABW	Arthur Armchair High Back Bumped back ABW Underframe	3526	3740	3996	4166	4464	4678	5062	5488	6042	6552	8.5	-

**COMPACT SOFA HIGH BACK  
1240H**



**DIMENSIONS**

Height: 1240mm (49")  
 Width: 2020mm (80")  
 Depth: 780mm (31")  
 Seat Height: 420mm (16.5")  
 Seat Depth: 530mm (20.75")

Code:	Description	COM /1	2	3	4	5	6	7	8	9	10	(ly)	(lb)
ART/8/OAK	Arthur Compact Sofa High Back Oak Underframe	5306	5644	6050	6320	6794	7132	7740	8416	9294	10104	13.50	
ART/8/ABW	Arthur Compact Sofa High Back American Black Walnut	5370	5708	6114	6384	6858	7196	7804	8480	9358	10168	13.50	-
ART/11/OAK	Arthur Compact Sofa High Back Bumped back Oak Underframe (As Shown)	5634	5984	6404	6684	7174	7524	8154	8854	9764	10604	14	
ART/11/ABW	Arthur Compact Sofa High Back Bumped back ABW Underframe	5700	6050	6470	6750	7240	7590	8220	8920	9830	10670	14	-

**LARGE SOFA HIGH BACK  
1240H**



**DIMENSIONS**

Height: 1240mm (49")  
 Width: 2320mm (91")  
 Depth: 780mm (31")  
 Seat Height: 420mm (16.5")  
 Seat Depth: 530mm (20.75")

Code:	Description	COM /1	2	3	4	5	6	7	8	9	10	(ly)	(lb)
ART/9/OAK	Arthur Large Sofa High Back Oak Underframe	5618	5956	6362	6632	7106	7444	8052	8728	9606	10416	13.50	
ART/9/ABW	Arthur Large Sofa High Back American Black Walnut	5680	6018	6424	6694	7168	7506	8114	8790	9668	10478	13.50	-
ART/12/OAK	Arthur Large Sofa High Back Bumped back Oak Underframe (As Shown)	5922	6272	6692	6972	7462	7812	8442	9142	10052	10892	14	
ART/12/ABW	Arthur Large Sofa High Back Bumped back ABW Underframe	5982	6332	6752	7032	7522	7872	8502	9202	10112	10952	14	-

**Options**

CODE:	DESCRIPTION	\$
-	Polished Aluminum Leg Set	116

**ARTHUR COFFEE TABLE**

**Code:**

**Description**

**\$**

  <b>DIMENSIONS</b> Height: 380mm (15") Width: 1200mm (47") Depth: 550mm (22")	<b>ART/25/OAK</b>	Arthur Coffee Table Oak Frame (As Shown)	1462
	<b>ART/25/ABW</b>	Arthur Coffee Table American Black Walnut Frame	1684



LOUNGE SEATING



# Bodie

Lounge Seating

boss



Inspired by refined comfort and the minimalist aesthetic of Scandinavian Modernism, Bodie has been created to provide practical luxury for a softer space.



LOUNGE SEATING

Designed, crafted and stitched by our master craftsmen; Bodie is the perfect choice for spaces where low maintenance and high comfort is required with an exquisite attention to detail.

















## Range Information

- The Bodie collection is available as an Armchair, Compact Sofa and Large sofa, appearing compact and neat within space, yet spacious and with generous comfort.
- Available with either Oak or American Black Walnut legs
- Removable foam and fibre seat & back cushions with zip detail
- Fibre filled arm cushions
- Shown photographed in Camira Yoredale UDA16 Nidd and Kvadrat Still 0871 & Still 0381.
- Not recommended to be upholstered in Grade 1 fabrics
- Timber Underframe available in Oak, American Black Walnut or to a painted finish (painted finish is \$236)



<b>BOD/1 ARMCHAIR</b>	<b>Code:</b>	<b>Description</b>	<b>COM</b> <b>/1</b>	<b>2</b>	<b>3</b>	<b>4</b>	<b>5</b>	<b>6</b>	<b>7</b>	<b>8</b>	<b>9</b>	<b>10</b>	<b>COL</b>	<b>L1</b>	<b>L2</b>	<b>L3</b>	 <b>(ly)</b>	 <b>(ft²)</b>	 <b>(lb)</b>
 <p><b>DIMENSIONS</b> Height: <b>760mm (30")</b> Width: <b>960mm (37.75")</b> Depth: <b>850mm (33.5")</b> Seat Height: <b>445mm (17.5")</b></p>	<b>BOD/1 OAK</b>	Bodie Armchair with Oak Frame	4040	4222	4440	4586	4840	5022	5350	5714	6186	6622	4266	6298	7542	11340	7.25	131.00	
	<b>BOD/1 ABW</b>	Bodie Armchair with ABW Frame	4208	4390	4608	4754	5008	5190	5518	5882	6354	6790	4434	6466	7710	11508	7.25	131.00	

<b>BOD/2 COMPACT SOFA</b>	<b>Code:</b>	<b>Description</b>	<b>COM</b> <b>/1</b>	<b>2</b>	<b>3</b>	<b>4</b>	<b>5</b>	<b>6</b>	<b>7</b>	<b>8</b>	<b>9</b>	<b>10</b>	<b>COL</b>	<b>L1</b>	<b>L2</b>	<b>L3</b>	 <b>(ly)</b>	 <b>(ft²)</b>	 <b>(lb)</b>
 <p><b>DIMENSIONS</b> Height: <b>760mm (30")</b> Width: <b>1850mm (72.75")</b> Depth: <b>850mm (33.5")</b> Seat Height: <b>445mm (17.5")</b></p>	<b>BOD/2 OAK</b>	Bodie Compact Sofa with Oak Frame	5830	6080	6380	6580	6930	7180	7630	8130	8780	9380	6142	8932	10642	15862	10.00	180.00	
	<b>BOD/2 ABW</b>	Bodie Compact Sofa with ABW Frame	5986	6236	6536	6736	7086	7336	7786	8286	8936	9536	6300	9090	10800	16020	10.00	180.00	

<b>BOD/3 LARGE SOFA</b>	<b>Code:</b>	<b>Description</b>	<b>COM</b> <b>/1</b>	<b>2</b>	<b>3</b>	<b>4</b>	<b>5</b>	<b>6</b>	<b>7</b>	<b>8</b>	<b>9</b>	<b>10</b>	<b>COL</b>	<b>L1</b>	<b>L2</b>	<b>L3</b>	 <b>(ly)</b>	 <b>(ft²)</b>	 <b>(lb)</b>
 <p><b>DIMENSIONS</b> Height: <b>760mm (30")</b> Width: <b>2150mm (84.75")</b> Depth: <b>850mm (33.5")</b> Seat Height: <b>445mm (17.5")</b></p>	<b>BOD/3 OAK</b>	Bodie Large Sofa with Oak Frame	7480	7800	8184	8440	8888	9208	9782	10420	11250	12016	7878	11444	13628	20298	12.75	230.00	
	<b>BOD/3 ABW</b>	Bodie Large Sofa with ABW Frame	7664	7984	8368	8624	9072	9392	9966	10604	11434	12200	8064	11630	13814	20484	12.75	230.00	







LOUNGE SEATING







## Range Information





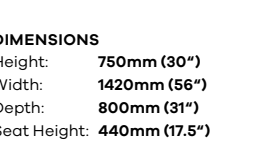

- Hardwood and plywood internal frame
- CMHR foam seat and back cushions
- Webbed seat and back construction
- Top stitch detail
- Polished aluminum or Timber legs
- A full range of line drawings and images in the Clarence range can be downloaded from our website [bossdesign.com](http://bossdesign.com)
- Not recommended to be upholstered in Grade 1 fabrics



<b>CLA/1/ ARMCHAIR</b>	<b>Code:</b>	<b>Description</b>	<b>COM /1</b>	<b>2</b>	<b>3</b>	<b>4</b>	<b>5</b>	<b>6</b>	<b>7</b>	<b>8</b>	<b>9</b>	<b>10</b>	<b>COL</b>	<b>L1</b>	<b>L2</b>	<b>L3</b>	 (ly)	 (ft²)	 (lb)
   <b>DIMENSIONS</b> Height: <b>750mm (30")</b> Width: <b>840mm (33")</b> Depth: <b>800mm (31")</b> Seat Height: <b>440mm (17.5")</b>	<b>CLA/1/ POL</b>	Armchair with Metal Legs	3104	3268	3464	3594	3822	3986	4280	4606	5030	5420	3302	5116	6228	9620	6.50	117	
	<b>CLA/1/ BEE</b>	Armchair with Beech Legs	3276	3440	3636	3766	3994	4158	4452	4778	5202	5592	3476	5290	6402	9794	6.50	117	
	<b>CLA/1/ OAK</b>	Armchair with Oak Legs	3324	3488	3684	3814	4042	4206	4500	4826	5250	5640	3524	5338	6450	9842	6.50	117	
	<b>CLA/1/ ABW</b>	Armchair with American Black Walnut Legs	3406	3570	3766	3896	4124	4288	4582	4908	5332	5722	3606	5420	6532	9924	6.50	117	

<b>CLA/2/ COMPACT SOFA</b>	<b>Code:</b>	<b>Description</b>	<b>COM /1</b>	<b>2</b>	<b>3</b>	<b>4</b>	<b>5</b>	<b>6</b>	<b>7</b>	<b>8</b>	<b>9</b>	<b>10</b>	<b>COL</b>	<b>L1</b>	<b>L2</b>	<b>L3</b>	 (ly)	 (ft²)	 (lb)
   <b>DIMENSIONS</b> Height: <b>750mm (30")</b> Width: <b>1420mm (56")</b> Depth: <b>800mm (31")</b> Seat Height: <b>440mm (17.5")</b>	<b>CLA/2/ POL</b>	Compact Sofa with Metal Legs	4006	4232	4502	4682	4998	5224	5630	6080	6666	7206	4276	6788	8326	13024	9.00	162	
	<b>CLA/2/ BEE</b>	Compact Sofa with Beech Legs	4174	4400	4670	4850	5166	5392	5798	6248	6834	7374	4444	6956	8494	13192	9.00	162	
	<b>CLA/2/ OAK</b>	Compact Sofa with Oak Legs	4228	4454	4724	4904	5220	5446	5852	6302	6888	7428	4500	7012	8550	13248	9.00	162	
	<b>CLA/2/ ABW</b>	Compact Sofa with American Black Walnut Legs	4302	4528	4798	4978	5294	5520	5926	6376	6962	7502	4574	7086	8624	13322	9.00	162	

LOUNGE SEATING

<b>CLA/3/ LARGE SOFA</b>	<b>Code:</b>	<b>Description</b>	<b>COM /1</b>	<b>2</b>	<b>3</b>	<b>4</b>	<b>5</b>	<b>6</b>	<b>7</b>	<b>8</b>	<b>9</b>	<b>10</b>	<b>COL</b>	<b>L1</b>	<b>L2</b>	<b>L3</b>	 (ly)	 (ft²)	 (lb)
   <b>DIMENSIONS</b> Height: <b>750mm (30")</b> Width: <b>2000mm (79")</b> Depth: <b>800mm (31")</b> Seat Height: <b>440mm (17.5")</b>	<b>CLA/3/ POL</b>	Large Sofa with Metal Legs	5028	5304	5634	5854	6240	6516	7012	7562	8278	8938	5358	8428	10308	16050	11.00	198	
	<b>CLA/3/ BEE</b>	Large Sofa with Beech Legs	5200	5476	5806	6026	6412	6688	7184	7734	8450	9110	5532	8602	10482	16224	11.00	198	
	<b>CLA/3/ OAK</b>	Large Sofa with Oak Legs	5246	5522	5852	6072	6458	6734	7230	7780	8496	9156	5578	8648	10528	16270	11.00	198	
	<b>CLA/3/ ABW</b>	Large Sofa with American Black Walnut Legs	5332	5608	5938	6158	6544	6820	7316	7866	8582	9242	5666	8736	10616	16358	11.00	198	

N.B. Leather is a natural material which will crease and 'puddle'.

 Fabric Linear Yard  Leather Square Footage  Product Weight

# Fairfax

Lounge Seating

boss



The Fairfax collection has a confident and contemporary aesthetic. Designed in-house, the collection is ideally suited to corporate reception and executive lounge areas.

The armchair, 2 and 3-seater sofas demonstrate excellent attention to detail and a superior level of upholstery that would not look out of place in a domestic setting.



LOUNGE SEATING







## Range Information

- Range includes, armchair, two seat and three seat sofa
- Scatter cushions are one size only 23" x 23" square
- Stitch detail
- Standard under side of seat cushion is upholstered in Camira Xtreme Havana
- Fully upholstered in any fabric or leather
- Painted legs available - POA
- Multiple density CMHR polyurethane foam
- Not recommended to be upholstered in Grade 1 fabrics
- Polished aluminum legs



**FAI/  
LOUNGE SEATING**

Code:	Description	COM /1	2	3	4	5	6	7	8	9	10	COL	L1	L2	L3	(ly)	(ft²)	(lb)
	<b>FAI/1</b> Armchair on polished legs	3824	4024	4264	4424	4704	4904	5264	5664	6184	6664	4066	6376	7792	12112	8	149	
<p>Height: <b>635mm (25")</b>                      Width: <b>955mm (37.75")</b>                      Depth: <b>890mm (35")</b>                      Seat Height: <b>375mm (14.75")</b>                      Seat Depth: <b>635mm (25")</b></p>																		
	<b>FAI/2</b> 2 seater sofa on polished legs	4898	5174	5504	5724	6110	6386	6882	7432	8148	8808	5226	8296	10176	15918	11	198	
<p>Height: <b>635mm (25")</b>                      Width: <b>1630mm (64.25")</b>                      Depth: <b>890mm (35")</b>                      Seat Height: <b>375mm (14.75")</b>                      Seat Depth: <b>635mm (25")</b></p>																		
	<b>FAI/3</b> 3 seater sofa on polished legs	6262	6588	6978	7238	7694	8020	8606	9256	10102	10882	6654	10360	12630	19560	13	239	
<p>Height: <b>635mm (25")</b>                      Width: <b>2240mm (88.25")</b>                      Depth: <b>890mm (35")</b>                      Seat Height: <b>375mm (14.75")</b>                      Seat Depth: <b>635mm (25")</b></p>																		
	<b>FAI/SC</b> Scatter Cushion (Per Cushion)	178	210	248	274	318	350	408	472	554	630	214	572	790	1456	1.25	23	
<p>Height: <b>580mm (22.75")</b>                      Width: <b>580mm (22.75")</b></p>																		

LOUNGE SEATING

N.B. Leather is a natural material which will crease and 'puddle'.

 Fabric Linear Yard  Leather Square Footage  Product Weight

# Flo

Lounge Seating

boss



Relaxed and refined – the Flo Lounge Collection has a poised stance and confident character. Defined contours along with the fine details and outstanding upholstery have created a sculpted form that is soft and alluring.



LOUNGE SEATING



## Range Information

- Flo armchair & Sofa Collection
- Large fabric pinch stitch detail
- Steel sub frame
- Oak leg finished with clear satin lacquer
- Glides for easy reconfiguration
- Available in a wide range of fabrics and leathers
- Not recommended to be upholstered in Band 1 fabrics
- Two-tone fabric options are available - Price on Application
- CMHR Moulded Foam to seat and back
- Sprung seat & backrest



**FLO/1  
LOUNGE CHAIR**

Code:	Description	COL /1	2	3	4	5	6	7	8	9	10	COL	L1	L2	L3	(ly)	(ft²)	(lb)
<b>FLO/1</b>	Flo armchair with oak legs	4792	4880	4986	5056	5180	5268	5426	5602	5830	6040	4930	5908	6506	8332	3.50	63	-



**DIMENSIONS**

Height: **760mm (30")**  
 Width: **900 mm (35.5")**  
 Depth: **840mm (33")**  
 Seat Height: **450mm (17.75")**  
 Arm Height: **610mm (24")**

**FLO/2  
LOUNGE SOFA**

Code:	Description	COL /1	2	3	4	5	6	7	8	9	10	COL	L1	L2	L3	(ly)	(ft²)	(lb)
<b>FLO/2</b>	Flo lounge sofa with oak legs	7100	7294	7526	7680	7950	8144	8492	8878	9380	9842	7368	9524	10844	14874	7.70	139	-



**DIMENSIONS**

Height: **760mm (30")**  
 Width: **2000mm (78.75")**  
 Depth: **840mm (33")**  
 Seat Height: **450mm (17.75")**  
 Arm Height: **610mm (24")**

LOUNGE SEATING

N.B. Leather is a natural material which will crease and 'puddle'.

Fabric Linear Yard Leather Square Footage Product Weight



# Layla

Lounge Seating

boss



Layla's graphic linear structure combines clean lines with generously padded upholstery and precise stitch detail for refined style and comfort. The sharp sculptural form and classic design incorporates a hardwood frame that sits on a refined chromed steel base or polished aluminum legs.

- Fully upholstered in fabric or leather
- CMHR moulded seat and back foams
- Chromed steel base or polished aluminum legs
- Complementary coffee table collection also available
- Not recommended to be upholstered in Grade 1 fabrics









LOUNGE SEATING

# Layla

Lounge Seating

boss

<b>LAY/1</b> <b>ARMCHAIR</b>	<b>Code:</b>	<b>Description</b>	<b>COM</b> <b>/1</b>	<b>2</b>	<b>3</b>	<b>4</b>	<b>5</b>	<b>6</b>	<b>7</b>	<b>8</b>	<b>9</b>	<b>10</b>	<b>COL</b>	<b>L1</b>	<b>L2</b>	<b>L3</b>	 <b>(ly)</b>	 <b>(ft²)</b>	 <b>(lb)</b>
 <p><b>DIMENSIONS</b>            Height: <b>660mm (26")</b>            Width: <b>850mm (33.5")</b>            Depth: <b>710mm (28")</b>            Seat Height: <b>400mm (16")</b>            Seat Depth: <b>550mm (21.5")</b>            Arm Height: <b>560mm (22")</b></p>	<b>LAY/1C</b>	Armchair chrome frame	3864	3978	4114	4204	4362	4476	4680	4906	5200	5470	4018	5274	6044	8392	4.50	81	
	<b>LAY/1P</b>	Armchair polished legs	2906	3020	3156	3246	3404	3518	3722	3948	4242	4512	3052	4308	5078	7426	4.50	81	

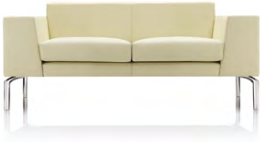
<b>LAY/2</b> <b>TWO SEAT SOFA</b>	<b>Code:</b>	<b>Description</b>	<b>COM</b> <b>/1</b>	<b>2</b>	<b>3</b>	<b>4</b>	<b>5</b>	<b>6</b>	<b>7</b>	<b>8</b>	<b>9</b>	<b>10</b>	<b>COL</b>	<b>L1</b>	<b>L2</b>	<b>L3</b>	 <b>(ly)</b>	 <b>(ft²)</b>	 <b>(lb)</b>
 <p><b>DIMENSIONS</b>            Height: <b>660mm (26")</b>            Width: <b>1610mm (63.5")</b>            Depth: <b>710mm (28")</b>            Seat Height: <b>400mm (16")</b>            Seat Depth: <b>550mm (21.5")</b>            Arm Height: <b>560mm (22")</b></p>	<b>LAY/2C</b>	Two seat sofa chrome frame	5036	5206	5410	5546	5784	5954	6258	6596	7036	7442	5260	7152	8310	11848	6.75	122	
	<b>LAY/2P</b>	Two seat sofa polished legs	4090	4260	4464	4600	4838	5008	5312	5650	6090	6496	4304	6196	7354	10892	6.75	122	

 Fabric Linear Yard  Leather Square Footage  Product Weight

**LAY/3**  
**THREE SEAT SOFA**



Code:	Description	COM /1	2	3	4	5	6	7	8	9	10	COL	L1	L2	L3	(ly)	(ft²)	(lb)
LAY/3C	Three seat sofa chrome frame	5694	5888	6122	6278	6550	6744	7094	7482	7986	8452	5948	8118	9448	13508	7.75	140	
LAY/3P	Three seat sofa polished legs	4924	5118	5352	5508	5780	5974	6324	6712	7216	7682	5170	7340	8670	12730	7.75	140	

**DIMENSIONS**  
 Height: **660mm (26")**  
 Width: **2000mm (79")**  
 Depth: **710mm (28")**  
 Seat Height: **400mm (16")**  
 Seat Depth: **550mm (21.5")**  
 Arm Height: **560mm (22")**

**LAY/4**  
**FOUR SEAT SOFA**



Code:	Description	COM /1	2	3	4	5	6	7	8	9	10	COL	L1	L2	L3	(ly)	(ft²)	(lb)
LAY/4C	Four seat sofa chrome frame	6674	6924	7224	7424	7774	8024	8474	8974	9624	10224	6994	9784	11494	16714	10	180	
LAY/4P	Four seat sofa polished legs	5846	6096	6396	6596	6946	7196	7646	8146	8796	9396	6158	8948	10658	15878	10	180	

**DIMENSIONS**  
 Height: **660mm (26")**  
 Width: **2540mm (100")**  
 Depth: **710mm (28")**  
 Seat Height: **400mm (16")**  
 Seat Depth: **550mm (21.5")**  
 Arm Height: **560mm (22")**

LOUNGE SEATING

N.B. Leather is a natural material which will crease and 'puddle'.

Fabric Linear Yard Leather Square Footage Product Weight





## Range Information

- Hardwood and plywood internal frame
- Timber underframe available in Oak, American Black Walnut or to a painted finish (painted finish is \$236)
- CMHR foam and fiber seat cushion
- CMHR foam and fiber back cushion
- Webbed seat and back suspension
- Top stitch detail to back cushion
- A full range of line drawings and images in the Lexe range can be downloaded from our website: [bossdesign.com](http://bossdesign.com)
- Not recommended to be upholstered in Grade 1 fabrics



ARMCHAIR	Code:	Description	COM	2	3	4	5	6	7	8	9	10	COL	L1	L2	L3	(ly)	(ft²)	(lb)
			/1																
 <p><b>DIMENSIONS</b>            Height: <b>840mm (33")</b>            Width: <b>715mm (28")</b>            Depth: <b>830mm (33")</b>            Seat Height: <b>450mm (17.75")</b>            Arm Height: <b>600mm (23.5")</b></p>	<b>LEX/1/OAK</b>	Lexe Armchair Oak underframe	3432	3632	3872	4032	4312	4512	4872	5272	5792	6272	3670	5840	7170	11230	8.00	140	
	<b>LEX/1/ABW</b>	Lexe Armchair American Black Walnut Underframe (As Shown)	3474	3674	3914	4074	4354	4554	4914	5314	5834	6314	3712	5882	7212	11272	8.00	140	

COMPACT SOFA	Code:	Description	COM	2	3	4	5	6	7	8	9	10	COL	L1	L2	L3	(ly)	(ft²)	(lb)
			/1																
 <p><b>DIMENSIONS</b>            Height: <b>840mm (33")</b>            Width: <b>1600mm (63")</b>            Depth: <b>830mm (33")</b>            Seat Height: <b>450mm (17.75")</b>            Arm Height: <b>600mm (23.5")</b></p>	<b>LEX/2/OAK</b>	Lexe Compact Sofa, Oak underframe (As Shown)	5488	5888	6368	6688	7248	7648	8368	9168	10208	11168	5948	10412	13148	21500	16.00	288	
	<b>LEX/2/ABW</b>	Lexe Compact Sofa, American Black Walnut Underframe	5544	5944	6424	6744	7304	7704	8424	9224	10264	11224	6004	10468	13204	21556	16.00	288	

LARGE SOFA	Code:	Description	COM	2	3	4	5	6	7	8	9	10	COL	L1	L2	L3	(ly)	(ft²)	(lb)
			/1																
 <p><b>DIMENSIONS</b>            Height: <b>840mm (33")</b>            Width: <b>2320mm (91")</b>            Depth: <b>830mm (33")</b>            Seat Height: <b>450mm (17.75")</b>            Arm Height: <b>600mm (23.5")</b></p>	<b>LEX/3/OAK</b>	Lexe Large Sofa, Oak underframe	6734	7160	7670	8010	8606	9032	9798	10648	11754	12774	7232	11836	14658	23270	17.00	297	
	<b>LEX/3/ABW</b>	Lexe Large Sofa, American Black Walnut Underframe (As Shown)	6810	7236	7746	8086	8682	9108	9874	10724	11830	12850	7310	11914	14736	23348	17.00	297	

LOUNGE SEATING

N.B. Leather is a natural material which will crease and 'puddle'.

 Fabric Linear Yard  Leather Square Footage  Product Weight



# Manta

Lounge Seating

boss



Featuring a two-seater sofa with matching armchair, this collection is designed to offer a compact and informal seating solution ideal for foyers and welcome areas.



LOUNGE SEATING

# Manta

Lounge Seating

boss



## Range Information

- CMHR molded seat and back foam
- Black painted legs, polished aluminum, or oak legs, with the option of a painted legs in any of our standard RAL Colors
- Twin needle & top stitch detail
- Sprung seat
- No restrictions on fabrics, leathers and vinyls
- Range includes armchair & sofa
- Plush upholstery option available on Armchair only
- Not recommended to be upholstered in Grade 1 fabrics



**MANTA  
ARMCHAIR**



**DIMENSIONS**

Height: **760mm (30")**  
 Width: **800mm (31")**  
 Depth: **760mm (30")**  
 Seat Height: **435mm (17.25")**  
 Arm Height: **580mm (23")**

Code:	Description	COM /1	2	3	4	5	6	7	8	9	10	COL	L1	L2	L3	(ly)	(ft²)	(lb)
<b>MAN/1/AL</b>	Armchair with cast aluminum legs	2944	3058	3194	3284	3442	3556	3760	3986	4280	4550	3090	4346	5116	7464	4.50	81	
<b>MAN/1/AL/PLUSH</b>	Armchair with cast aluminum legs and Plush upholstery	3094	3208	3344	3434	3592	3706	3910	4136	4430	4700	3242	4498	5268	7616	4.50	81	
<b>MAN/1/OAK</b>	Armchair with oak legs	3336	3450	3586	3676	3834	3948	4152	4378	4672	4942	3486	4742	5512	7860	4.50	81	
<b>MAN/1/OAK/PLUSH</b>	Armchair with oak legs and plush upholstery	3492	3606	3742	3832	3990	4104	4308	4534	4828	5098	3644	4900	5670	8018	4.50	81	

**MANTA  
SOFA**



**DIMENSIONS**

Height: **760mm (30")**  
 Width: **1630mm (64.25")**  
 Depth: **765mm (30.25")**  
 Seat Height: **435mm (17.25")**  
 Arm Height: **580mm (23")**

Code:	Description	COM /1	2	3	4	5	6	7	8	9	10	COL	L1	L2	L3	(ly)	(ft²)	(lb)
<b>MAN/2/AL</b>	Sofa cast aluminum legs	4494	4664	4868	5004	5242	5412	5716	6054	6494	6900	4712	6604	7762	11300	6.75	122	
<b>MAN/2/OAK</b>	Sofa with oak legs	4886	5056	5260	5396	5634	5804	6108	6446	6886	7292	5108	7000	8158	11696	6.75	122	

LOUNGE SEATING

N.B. Leather is a natural material which will crease and 'puddle'.

Fabric Linear Yard Leather Square Footage Product Weight

**Painted Frame Options**

Color Choice	RAL 9005	RAL 9016	RAL 060 60 05	RAL 240 20 22	RAL 220 70 10	RAL 130 30 20	RAL 040 50 50	RAL 070 70 80
Suffix*	PF/B	PF/W	PF/SG	PF/DB	PF/LB	PF/GN	PF/CR	PF/Y
\$	100	100	100	100	100	100	100	100



# Maysa

Lounge & Modular Seating Systems

boss





Maysa sits perfectly in high end hotel lounges or luxury lobbies and executive office spaces. A modular collection comprised of sofas, armchair and coffee tables, the collection brings a timeless elegance to the most ordinary of spaces.







## Range Information

- Hardwood and plywood internal frame
- CMHR foam and fixed seat
- CMHR fixed foam back
- Timber: Oak and ABW
- Top stitch detail
- Available in fabric and leather upholstery
- Two-tone options available
- Scatter cushions not included.
- Not recommended to be upholstered in Grade 1 fabrics
- Timber Underframe available in Oak, American Black Walnut or to a painted finish (painted finish is \$236)



ARMCHAIR	Code:	Description	COM /1	2	3	4	5	6	7	8	9	10	COL	L1	L2	L3	(ly)	(ft²)	(lb)
					<b>MAY/1/OAK</b>	Armchair with Oak frame (As Shown)	4646	4746	4866	4946	5086	5186	5366	5566	5826	6066	4794	5910	6594
	<b>MAY/1/ABW</b>	Armchair with ABW frame	4766	4866	4986	5066	5206	5306	5486	5686	5946	6186	4916	6032	6716	8804	4.00	72	

**DIMENSIONS**  
 Height: **705mm (27.75")**  
 Width: **1070mm (42.25")**  
 Depth: **880mm (34.75")**  
 Seat Height: **435mm (17.25")**

COMPACT SOFA	Code:	Description	COM /1	2	3	4	5	6	7	8	9	10	COL	L1	L2	L3	(ly)	(ft²)	(lb)
					<b>MAY/2/OAK</b>	Compact Sofa with Oak frame (As Shown)	7348	7568	7832	8008	8316	8536	8930	9368	9938	10464	7644	10094	11594
	<b>MAY/2/ABW</b>	Compact Sofa with ABW frame	7518	7738	8002	8178	8486	8706	9100	9538	10108	10634	7816	10266	11766	16348	8.75	158	

**DIMENSIONS**  
 Height: **705mm (27.75")**  
 Width: **1900mm (74.75")**  
 Depth: **880mm (34.75")**  
 Seat Height: **435mm (17.25")**

LARGE SOFA	Code:	Description	COM /1	2	3	4	5	6	7	8	9	10	COL	L1	L2	L3	(ly)	(ft²)	(lb)
					<b>MAY/3/OAK</b>	Large Sofa with Oak frame (As Shown)	8034	8254	8518	8694	9002	9222	9616	10054	10624	11150	8338	10788	12288
	<b>MAY/3/ABW</b>	Large Sofa with ABW frame	8262	8482	8746	8922	9230	9450	9844	10282	10852	11378	8568	11018	12518	17100	8.75	158	

**DIMENSIONS**  
 Height: **705mm (27.75")**  
 Width: **2300mm (90.5")**  
 Depth: **880mm (34.75")**  
 Seat Height: **435mm (17.25")**

LOUNGE SEATING

N.B. Leather is a natural material which will crease and 'puddle'.

 Fabric Linear Yard  Leather Square Footage  Product Weight

**MODULAR CORNER UNIT**



**DIMENSIONS**

Height: **705mm (27.75")**  
 Width: **880mm (34.75")**  
 Depth: **880mm (34.75")**  
 Seat Height: **435mm (17.25")**

Code:	Description	COM /1	2	3	4	5	6	7	8	9	10	COL	L1	L2	L3	(ly)	(ft²)	(lb)
MAY/MOD/C/OAK	Corner Unit with Oak frame (As Shown)	3830	3944	4080	4170	4328	4442	4646	4872	5166	5436	3984	5240	6010	8358	4.50	81	
MAY/MOD/C/ABW	Corner Unit with ABW frame	3864	3978	4114	4204	4362	4476	4680	4906	5200	5470	4018	5274	6044	8392	4.50	81	

**MODULAR CHAISE RHS**



**DIMENSIONS**

Height: **705mm (27.75")**  
 Width: **1360mm (53.75")**  
 Depth: **880mm (34.75")**  
 Seat Height: **435mm (17.25")**

Code:	Description	COM /1	2	3	4	5	6	7	8	9	10	COL	L1	L2	L3	(ly)	(ft²)	(lb)
MAY/MOD/CHS/RHS/OAK	Chaise RHS with Oak frame (As Shown)	5362	5500	5666	5776	5970	6108	6356	6632	6990	7320	5556	7092	8032	10902	5.50	99	
MAY/MOD/CHS/RHS/ABW	Chaise RHS with ABW frame	5546	5684	5850	5960	6154	6292	6540	6816	7174	7504	5742	7278	8218	11088	5.50	99	

**MODULAR CHAISE LHS**



**DIMENSIONS**

Height: **705mm (27.75")**  
 Width: **1360mm (53.75")**  
 Depth: **880mm (34.75")**  
 Seat Height: **435mm (17.25")**

Code:	Description	COM /1	2	3	4	5	6	7	8	9	10	COL	L1	L2	L3	(ly)	(ft²)	(lb)
MAY/MOD/CHS/LHS/OAK	Chaise LHS with Oak frame (As Shown)	5362	5500	5666	5776	5970	6108	6356	6632	6990	7320	5556	7092	8032	10902	5.50	99	
MAY/MOD/CHS/LHS/ABW	Chaise LHS with ABW frame	5546	5684	5850	5960	6154	6292	6540	6816	7174	7504	5742	7278	8218	11088	5.50	99	

N.B. Leather is a natural material which will crease and 'puddle'.

Fabric Linear Yard Leather Square Footage Product Weight

MODULAR NON ARM	Code:	Description	COM	2	3	4	5	6	7	8	9	10	COL	L1	L2	L3	(ly)	(ft²)	(lb)
			/1																
 <p><b>DIMENSIONS</b>            Height: <b>705mm (27.75")</b>            Width: <b>850mm (33.5")</b>            Depth: <b>880mm (34.75")</b>            Seat Height: <b>435mm (17.25")</b></p>	<b>MAY/ MOD/1/850 OAK</b>	Modular Non-Arm 33.5" with Oak frame (As Shown)	3964	4064	4184	4264	4404	4504	4684	4884	5144	5384	4106	5222	5906	7994	4.00	72	
	<b>MAY/ MOD/1/850/ ABW</b>	Modular Non-Arm 33.5" with ABW frame	4090	4190	4310	4390	4530	4630	4810	5010	5270	5510	4232	5348	6032	8120	4.00	72	

MODULAR LARGE SOFA RHS	Code:	Description	COM	2	3	4	5	6	7	8	9	10	COL	L1	L2	L3	(ly)	(ft²)	(lb)
			/1																
 <p><b>DIMENSIONS</b>            Height: <b>705mm (27.75")</b>            Width: <b>1995mm (78.5")</b>            Depth: <b>880mm (34.75")</b>            Seat Height: <b>435mm (17.25")</b></p>	<b>MAY/ MOD/3/ RHS/OAK</b>	Large Modular Sofa with Oak frame RHS (As Shown)	7830	8038	8286	8452	8742	8950	9322	9736	10274	10770	8120	10430	11846	16166	8.25	149	
	<b>MAY/ MOD/3/ RHS/ABW</b>	Large Modular Sofa with ABW frame RHS	8042	8250	8498	8664	8954	9162	9534	9948	10486	10982	8334	10644	12060	16380	8.25	149	

MODULAR LARGE SOFA LHS	Code:	Description	COM	2	3	4	5	6	7	8	9	10	COL	L1	L2	L3	(ly)	(ft²)	(lb)
			/1																
 <p><b>DIMENSIONS</b>            Height: <b>705mm (27.75")</b>            Width: <b>1995mm (78.5")</b>            Depth: <b>880mm (34.75")</b>            Seat Height: <b>435mm (17.25")</b></p>	<b>MAY/ MOD/3/ LHS/OAK</b>	Large Modular Sofa with Oak frame LHS (As Shown)	7830	8038	8286	8452	8742	8950	9322	9736	10274	10770	8120	10430	11846	16166	8.25	149	
	<b>MAY/ MOD/3/ LHS/ABW</b>	Large Modular Sofa with ABW frame LHS	8042	8250	8498	8664	8954	9162	9534	9948	10486	10982	8334	10644	12060	16380	8.25	149	

LOUNGE & MODULAR SEATING SYSTEMS

N.B. Leather is a natural material which will crease and 'puddle'.  Fabric Linear Yard  Leather Square Footage  Product Weight

**MODULAR CORNER TABLE**

Code:

Description

\$

(lb)



MAY/MOD/CT/OAK

Modular Corner Coffee Table in Oak

2156

-

MAY/MOD/CT/ABW

Modular Corner Coffee Table in ABW  
(As Shown)

2508

-

**DIMENSIONS**

Height: 275mm (10.75")

Width: 860mm (34")

Depth: 860mm (34")

**860MM COFFEE TABLE**

Code:

Description

\$

(lb)



MAY/CT/860/OAK

34" x 34" Square Coffee Table in Oak

3028

-

MAY/CT/860/ABW

34" x 34" Square Coffee Table in ABW  
(As Shown)

3418

-

**DIMENSIONS**

Height: 275mm (10.75")

Width: 860mm (34")

Depth: 860mm (34")

**1360MM COFFEE TABLE**

Code:

Description

\$

(lb)



MAY/CT/1360/OAK

53.5" x 34" Rectangular coffee table in Oak

3514

-

MAY/CT/1360/ABW

53.5" x 34" Rectangular coffee table in ABW  
(As Shown)

4132

-

**DIMENSIONS**

Height: 275mm (10.75")

Width: 1360mm (53.5")

Depth: 860mm (34")

Fabric Linear Yards Product Weight

# Maysa Configurations

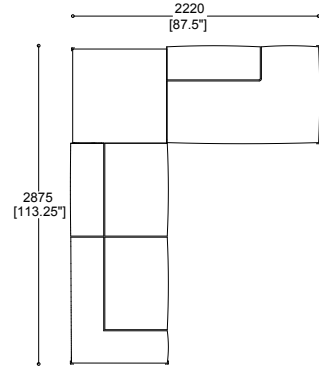

MAY/MOD/3/RHS (LHS), MAY/MOD/CT & MAY/MOD/CHS/RHS (LHS)

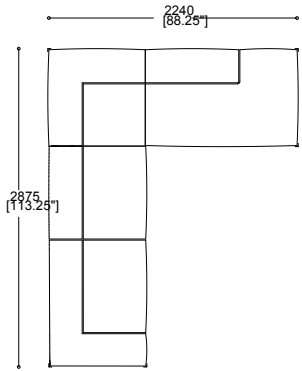

MAY/MOD/3/RHS (LHS), MAY/MOD/C & MAY/MOD/CHS/RHS (LHS)



LOUNGE & MODULAR SEATING SYSTEMS

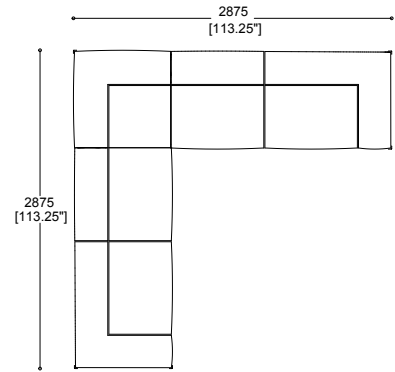

MAY/MOD/3/RHS (LHS), MAY/MOD/C & MAY/MOD/3/LHS (RHS)

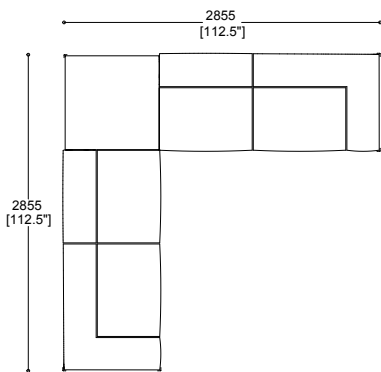

MAY/MOD/3/RHS (LHS), MAY/MOD/CT & MAY/MOD/3/LHS (RHS)







## Range Information

- Hardwood and plywood internal frame
- CMHR foam and fiber seat cushion
- CMHR foam and feather back cushion
- Webbed seat and back support
- Top stitch detail
- Polished aluminum legs
- Sofa available with long arm (to create configurations)
- Where units are to be linked (and linking mechanisms required), a plan drawing must be submitted to confirm the layout required
- Not recommended to be upholstered in Grade 1 fabrics



OLI/1 LARGE SOFA	Code:	Description	COM /1	2	3	4	5	6	7	8	9	10	COL	L1	L2	L3	(ly)	(ft²)	(lb)
	OLI/1	Olivia large sofa armless	4932	5290	5718	6004	6504	6862	7504	8218	9146	10002	5344	9328	11770	19222	14.25	257	
<b>DIMENSIONS</b> Height: 800mm (31.5") Width: 1800mm (70.75") Depth: 1020mm (40.25") Seat Height: 400mm (15.75")																			

OLI/2 LARGE SOFA	Code:	Description	COM /1	2	3	4	5	6	7	8	9	10	COL	L1	L2	L3	(ly)	(ft²)	(lb)
	OLI/2/ LHS OR RHS	Olivia large sofa, single arm  LHS Short Arm version shown	5202	5590	6056	6366	6910	7298	7996	8772	9780	10710	5646	9972	12622	20712	15.50	279	
<b>DIMENSIONS</b> Height: 800mm (31.5") Width: 1920mm (75.5") Depth: 1020mm (40.25") Seat Height: 400mm (15.75") Arm Height: 630mm (24.75")																			





OLI/3 LARGE SOFA	Code:	Description	COM /1	2	3	4	5	6	7	8	9	10	COL	L1	L2	L3	(ly)	(ft²)	(lb)
	OLI/3	Olivia large sofa Short Arm version shown	5510	5924	6420	6750	7328	7742	8486	9312	10386	11376	5984	10588	13410	22022	16.50	297	
<b>DIMENSIONS</b> Height: 800mm (31.5") Width: 2030mm (80") Depth: 1020mm (40.25") Seat Height: 400mm (15.75") Arm Height: 630mm (24.75")																			

LOUNGE SEATING

N.B. Leather is a natural material which will crease and 'puddle'. 📏 Fabric Linear Yard 👜 Leather Square Footage 📊 Product Weight





**Options**

CODE:	DESCRIPTION	\$
	Set of 2 linking mechanisms	108

<b>OLI/4 CORNER UNIT</b>	<b>Code:</b>	<b>Description</b>	<b>COM</b>	<b>2</b>	<b>3</b>	<b>4</b>	<b>5</b>	<b>6</b>	<b>7</b>	<b>8</b>	<b>9</b>	<b>10</b>	<b>COL</b>	<b>L1</b>	<b>L2</b>	<b>L3</b>	 <b>(ly)</b>	 <b>(ft²)</b>	 <b>(lb)</b>
	<b>OLI/4</b>	Olivia corner unit	3322	3572	3872	4072	4422	4672	5122	5622	6272	6872	3608	6398	8108	13328	10.00	180	



**DIMENSIONS**

Height: **800mm (31.5")**  
 Width: **1020mm (40.25")**  
 Depth: **1020mm (40.25")**  
 Seat Height: **400mm (15.75")**  
 Arm Height: **630mm (24.75")**

<b>OLI/5 CHAISE</b>	<b>Code:</b>	<b>Description</b>	<b>COM</b>	<b>2</b>	<b>3</b>	<b>4</b>	<b>5</b>	<b>6</b>	<b>7</b>	<b>8</b>	<b>9</b>	<b>10</b>	<b>COL</b>	<b>L1</b>	<b>L2</b>	<b>L3</b>	 <b>(ly)</b>	 <b>(ft²)</b>	 <b>(lb)</b>
	<b>OLI/5/ LHS OR RHS</b>	Olivia chaise LHS Shown	4468	4744	5074	5294	5680	5956	6452	7002	7718	8378	4792	7862	9742	15484	11.00	198	

**DIMENSIONS**

Height: **800mm (31.5")**  
 Width: **1500mm (59")**  
 Depth: **1020mm (40.25")**  
 Seat Height: **400mm (15.75")**  
 Arm Height: **630mm (24.75")**

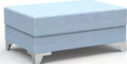



<b>OLI/6 STANDARD FOOTSTOOL</b>	<b>Code:</b>	<b>Description</b>	<b>COM</b>	<b>2</b>	<b>3</b>	<b>4</b>	<b>5</b>	<b>6</b>	<b>7</b>	<b>8</b>	<b>9</b>	<b>10</b>	<b>COL</b>	<b>L1</b>	<b>L2</b>	<b>L3</b>	 <b>(ly)</b>	 <b>(ft²)</b>	 <b>(lb)</b>
	<b>OLI/6</b>	Olivia standard footstool	1362	1462	1582	1662	1802	1902	2082	2282	2542	2782	1478	2594	3278	5366	4.00	72	





**DIMENSIONS**

Height: **400mm (15.75")**  
 Width: **900mm (35.5")**  
 Depth: **600mm (23.5")**

N.B. Leather is a natural material which will crease and 'puddle'.

 Fabric Linear Yard  Leather Square Footage  Product Weight

<b>OLI/7 LARGE FOOTSTOOL</b>	<b>Code:</b>	<b>Description</b>	<b>COM</b>	<b>2</b>	<b>3</b>	<b>4</b>	<b>5</b>	<b>6</b>	<b>7</b>	<b>8</b>	<b>9</b>	<b>10</b>	<b>COL</b>	<b>L1</b>	<b>L2</b>	<b>L3</b>	 <b>(ly)</b>	 <b>(ft²)</b>	 <b>(lb)</b>
	<b>OLI/7</b>	Olivia large footstool	1934	2072	2238	2348	2542	2680	2928	3204	3562	3892	2094	3630	4570	7440	5.50	99	
<b>DIMENSIONS</b> Height: <b>400mm (15.75")</b> Width: <b>1020mm (40.25")</b> Depth: <b>1020mm (40.25")</b>																			

<b>OLI/8 ARMCHAIR</b>	<b>Code:</b>	<b>Description</b>	<b>COM</b>	<b>2</b>	<b>3</b>	<b>4</b>	<b>5</b>	<b>6</b>	<b>7</b>	<b>8</b>	<b>9</b>	<b>10</b>	<b>COL</b>	<b>L1</b>	<b>L2</b>	<b>L3</b>	 <b>(ly)</b>	 <b>(ft²)</b>	 <b>(lb)</b>
	<b>OLI/8</b>	Olivia Armchair	3618	3788	3992	4128	4366	4536	4840	5178	5618	6024	3826	5718	6876	10414	6.75	122	
<b>DIMENSIONS</b> Height: <b>800mm (31.5")</b> Width: <b>900mm (35.5")</b> Depth: <b>950mm (37.5")</b> Seat Height: <b>400mm (15.75")</b> Arm Height: <b>630mm (24.75")</b>																			

LOUNGE SEATING

N.B. Leather is a natural material which will crease and 'puddle'.

 Fabric Linear Yard  Leather Square Footage  Product Weight

### Options

<b>CODE:</b>	<b>DESCRIPTION</b>	<b>\$</b>
	Set of 2 linking mechanisms	108

# Orten

Lounge Seating

boss



## Range Information

- Timber underframe available in Oak, American Black Walnut or to a painted finish (painted finish is \$236)
- Top stitch detail
- CMHR foam and feather seat and back cushions
- Webbed seat support
- Loose seat cushions, loose back cushions
- A full range of line drawings and images in the Orten range can be downloaded from our website [bossdesign.com](http://bossdesign.com)
- Not recommended to be upholstered in Grade 1 fabrics



LOUNGE SEATING





This collection is ideal for a wide variety of interiors, including corporate office receptions, executive meeting areas and hospitality environments.

The collection is undeniably a striking design and echoes Boss's impeccable manufacturing expertise and ability to combine the finest quality solid timber with unparalleled craftsmanship.

# Orten



Lounge Seating

boss

SMALL ARMCHAIR	Code:	Description	COM /1	2	3	4	5	6	7	8	9	10	COL	L1	L2	L3	(ly)	(ft²)	(lb)
	ORT/1	Orten small armchair with Oak legs (As Shown)	3626	3764	3930	4040	4234	4372	4620	4896	5254	5584	3802	5338	6278	9148	5.50	99	
	ORT/1/B	Orten small armchair with ABW legs	3762	3900	4066	4176	4370	4508	4756	5032	5390	5720	3940	5476	6416	9286	5.50	99	
	ORT/1/H	Orten small armchair with Oak H frame (As Shown)	3726	3864	4030	4140	4334	4472	4720	4996	5354	5684	3904	5440	6380	9250	5.50	99	
	ORT/1/HB	Orten small armchair with ABW H frame	3872	4010	4176	4286	4480	4618	4866	5142	5500	5830	4052	5588	6528	9398	5.50	99	

**DIMENSIONS**

Height: 720mm (28")  
 Width: 760mm (30")  
 Depth: 850mm (33")



LARGE ARMCHAIR	Code:	Description	COM /1	2	3	4	5	6	7	8	9	10	COL	L1	L2	L3	(ly)	(ft²)	(lb)
	ORT/1A	Orten large armchair with Oak legs (As Shown)	4114	4308	4542	4698	4970	5164	5514	5902	6406	6872	4352	6522	7852	11912	7.75	140	
	ORT/1A/B	Orten large armchair with ABW legs	4190	4384	4618	4774	5046	5240	5590	5978	6482	6948	4428	6598	7928	11988	7.75	140	
	ORT/1A/H	Orten large armchair with Oak H frame (As Shown)	4182	4376	4610	4766	5038	5232	5582	5970	6474	6940	4420	6590	7920	11980	7.75	140	
	ORT/1A/HB	Orten large armchair with ABW H frame	4300	4494	4728	4884	5156	5350	5700	6088	6592	7058	4540	6710	8040	12100	7.75	140	

**DIMENSIONS**



Height: 720mm (28")  
 Width: 960mm (38")  
 Depth: 850mm (33")

N.B. Leather is a natural material which will crease and 'puddle'.

 Fabric Linear Yard  Leather Square Footage  Product Weight

TWO SEAT SOFA		Code:	Description	COM /1	2	3	4	5	6	7	8	9	10	COL	L1	L2	L3	(ly)	(ft²)	(lb)
	ORT/2	Orten 2 seat sofa with Oak legs (As Shown)	5792	6068	6398	6618	7004	7280	7776	8326	9042	9702	6130	9200	11080	16822	11.00	198		
	ORT/2/B	Orten 2 seat sofa with ABW legs	6126	6402	6732	6952	7338	7614	8110	8660	9376	10036	6468	9538	11418	17160	11.00	198		
	ORT/2/H	Orten 2 seat sofa with Oak H frame (As Shown)	6002	6278	6608	6828	7214	7490	7986	8536	9252	9912	6342	9412	11292	17034	11.00	198		
	ORT/2/HB	Orten 2 seat sofa with ABW H frame	6322	6598	6928	7148	7534	7810	8306	8856	9572	10232	6664	9734	11614	17356	11.00	198		

**DIMENSIONS**  
 Height: 720mm (28")  
 Width: 1760mm (69")  
 Depth: 850mm (33")

THREE SEAT SOFA		Code:	Description	COM /1	2	3	4	5	6	7	8	9	10	COL	L1	L2	L3	(ly)	(ft²)	(lb)
	ORT/3	Orten 3 seat sofa with Oak legs (As Shown)	7400	7788	8254	8564	9108	9496	10194	10970	11978	12908	7866	12192	14842	22932	15.50	279		
	ORT/3/B	Orten 3 seat sofa with ABW legs	7550	7938	8404	8714	9258	9646	10344	11120	12128	13058	8018	12344	14994	23084	15.50	279		
	ORT/3/H	Orten 3 seat sofa with Oak H frame (As Shown)	7648	8036	8502	8812	9356	9744	10442	11218	12226	13156	8118	12444	15094	23184	15.50	279		
	ORT/3/HB	Orten 3 seat sofa with ABW H frame	7812	8200	8666	8976	9520	9908	10606	11382	12390	13320	8282	12608	15258	23348	15.50	279		

**DIMENSIONS**  
 Height: 720mm (28")  
 Width: 2260mm (89")  
 Depth: 850mm (33")

LOUNGE SEATING

N.B. Leather is a natural material which will crease and 'puddle'.

 Fabric Linear Yard  Leather Square Footage  Product Weight

# Orten Modular

Lounge & Modular Seating Systems



boss





## Range Information

- Timber underframe available in Oak, American Black Walnut or to a painted finish (painted finish is \$236)
- Top stitch detail
- CMHR foam and feather seat and back cushions
- Webbed seat support
- Loose seat cushions, loose back cushions
- Where units are to be linked (and linking mechanisms required), a plan drawing must be submitted to confirm the layout required
- A full range of line drawings and images in the Orten Modular range can be downloaded from our website: [bossdesign.com/us](https://bossdesign.com/us)
- Not recommended to be upholstered in Grade 1 fabrics





CORNER UNIT	Code:	Description	COM /1	2	3	4	5	6	7	8	9	10	COL	L1	L2	L3					
																				(ly)	(ft <sup>2</sup> )
	<b>ORT/4</b>	Corner unit, leg frame, Oak (As Shown)	3408	3546	3712	3822	4016	4154	4402	4678	5036	5366	3582	5118	6058	8928	5.50	99			
	<b>ORT/4/B</b>	Corner unit with ABW legs	3582	3720	3886	3996	4190	4328	4576	4852	5210	5540	3758	5294	6234	9104	5.50	99			
	<b>ORT/4/H</b>	Corner unit with Oak H frame (As Shown)	3746	3884	4050	4160	4354	4492	4740	5016	5374	5704	3924	5460	6400	9270	5.50	99			
	<b>ORT/4/HB</b>	Corner unit with ABW H frame	3892	4030	4196	4306	4500	4638	4886	5162	5520	5850	4072	5608	6548	9418	5.50	99			

**DIMENSIONS**  
 Height: **720mm (28")**  
 Width: **850mm (33")**  
 Depth: **850mm (33")**

SINGLE ARM ARMCHAIR	Code:	Description	COM /1	2	3	4	5	6	7	8	9	10	COL	L1	L2	L3					
																				(ly)	(ft <sup>2</sup> )
	<b>ORT/5</b>	Single arm armchair Oak legs (LH shown)	3610	3748	3914	4024	4218	4356	4604	4880	5238	5568	3786	5322	6262	9132	5.50	99			
	<b>ORT/5/B</b>	Single arm armchair with ABW legs	3712	3850	4016	4126	4320	4458	4706	4982	5340	5670	3890	5426	6366	9236	5.50	99			
	<b>ORT/5/H</b>	Single arm armchair Oak H frame (LH shown)	3650	3788	3954	4064	4258	4396	4644	4920	5278	5608	3826	5362	6302	9172	5.50	99			
	<b>ORT/5/HB</b>	Single arm armchair with ABW H frame	3824	3962	4128	4238	4432	4570	4818	5094	5452	5782	4002	5538	6478	9348	5.50	99			

**DIMENSIONS**  
 Height: **720mm (28")**  
 Width: **680mm (27")**  
 Depth: **850mm (33")**

N.B. Leather is a natural material which will crease and 'puddle'.

 Fabric Linear Yard  Leather Square Footage  Product Weight

LOUNGE & MODULAR SEATING SYSTEMS

## SINGLE ARM LARGE ARMCHAIR



### DIMENSIONS

Height: 720mm (28")  
 Width: 880mm (35")  
 Depth: 850mm (33")

Code:	Description	COM /1	2	3	4	5	6	7	8	9	10	COL	L1	L2	L3	(ly)	(ft²)	(lb)
<b>ORT/6</b>	Orten single arm large armchair with Oak legs (LH shown)	3888	4082	4316	4472	4744	4938	5288	5676	6180	6646	4124	6294	7624	11684	7.75	140	
<b>ORT/6/B</b>	Single arm large armchair with ABW legs	3994	4188	4422	4578	4850	5044	5394	5782	6286	6752	4230	6400	7730	11790	7.75	140	
<b>ORT/6/H</b>	Single arm large armchair Oak H frame (LH shown)	3930	4124	4358	4514	4786	4980	5330	5718	6222	6688	4166	6336	7666	11726	7.75	140	
<b>ORT/6/HB</b>	Single arm large armchair with ABW H frame	4104	4298	4532	4688	4960	5154	5504	5892	6396	6862	4342	6512	7842	11902	7.75	140	

## SINGLE ARM 2 SEAT SOFA



### DIMENSIONS

Height: 720mm (28")  
 Width: 1680mm (66")  
 Depth: 850mm (33")

Code:	Description	COM /1	2	3	4	5	6	7	8	9	10	COL	L1	L2	L3	(ly)	(ft²)	(lb)
<b>ORT/7</b>	Single arm 2 seat sofa with Oak legs (LH shown)	5796	6072	6402	6622	7008	7284	7780	8330	9046	9706	6134	9204	11084	16826	11.00	198	
<b>ORT/7/B</b>	Single arm 2 seat sofa ABW legs	6046	6322	6652	6872	7258	7534	8030	8580	9296	9956	6386	9456	11336	17078	11.00	198	
<b>ORT/7/H</b>	Single arm 2 seat sofa Oak H frame (LH shown)	5962	6238	6568	6788	7174	7450	7946	8496	9212	9872	6302	9372	11252	16994	11.00	198	
<b>ORT/7/HB</b>	Single arm 2 seat sofa with ABW H frame	6244	6520	6850	7070	7456	7732	8228	8778	9494	10154	6586	9656	11536	17278	11.00	198	

**SINGLE ARM 3 SEAT SOFA**



**DIMENSIONS**

Height: **720mm (28")**  
 Width: **2180mm (86")**  
 Depth: **850mm (33")**

Code:	Description	COM /1	2	3	4	5	6	7	8	9	10	COL	L1	L2	L3	(ly)	(ft <sup>2</sup> )	(lb)
<b>ORT/8</b>	Single arm 3 seat sofa with Oak legs (LH shown)	7158	7546	8012	8322	8866	9254	9952	10728	11736	12666	7622	11948	14598	22688	15.50	279	
<b>ORT/8/B</b>	Single arm 3 seat sofa ABW legs	7396	7784	8250	8560	9104	9492	10190	10966	11974	12904	7862	12188	14838	22928	15.50	279	
<b>ORT/8/H</b>	Single arm 3 seat sofa Oak H frame (LH Shown)	7380	7768	8234	8544	9088	9476	10174	10950	11958	12888	7846	12172	14822	22912	15.50	279	
<b>ORT/8/HB</b>	Single arm 3 seat sofa with ABW H frame	7610	7998	8464	8774	9318	9706	10404	11180	12188	13118	8078	12404	15054	23144	15.50	279	

**1 SEAT ARMLESS UNIT**





**DIMENSIONS**

Height: **720mm (28")**  
 Width: **600mm (24")**  
 Depth: **850mm (33")**

Code:	Description	COM /1	2	3	4	5	6	7	8	9	10	COL	L1	L2	L3	(ly)	(ft <sup>2</sup> )	(lb)
<b>ORT/9</b>	1 seat Armless Unit, with Oak legs (As Shown)	3532	3670	3836	3946	4140	4278	4526	4802	5160	5490	3708	5244	6184	9054	5.50	99	-
<b>ORT/9/B</b>	1 seat Armless Unit, with ABW legs	3664	3802	3968	4078	4272	4410	4658	4934	5292	5622	3842	5378	6318	9188	5.50	99	-
<b>ORT/9/H</b>	1 seat Armless Unit, Oak H Frame (As Shown)	3630	3768	3934	4044	4238	4376	4624	4900	5258	5588	3806	5342	6282	9152	5.50	99	-
<b>ORT/9/HB</b>	1 seat Armless Unit, with ABW H Frame	3770	3908	4074	4184	4378	4516	4764	5040	5398	5728	3948	5484	6424	9294	5.50	99	-



### 1 SEAT LARGE ARMLESS UNIT

Code:	Description	COM /1	2	3	4	5	6	7	8	9	10	COL	L1	L2	L3	(ly)	(ft²)	(lb)
 <b>ORT/10</b>	1 seat Large Armless Unit with Oak legs (As Shown)	4006	4200	4434	4590	4862	5056	5406	5794	6298	6764	4242	6412	7742	11802	7.75	140	-
<b>ORT/10/B</b>	1 seat Large Armless Unit with ABW legs	4080	4274	4508	4664	4936	5130	5480	5868	6372	6838	4318	6488	7818	11878	7.75	140	-
 <b>ORT/10/H</b>	1 seat Large Armless Unit Oak H Frame (As Shown)	4074	4268	4502	4658	4930	5124	5474	5862	6366	6832	4312	6482	7812	11872	7.75	140	-
<b>ORT/10/HB</b>	1 seat Large Armless Unit with ABW H Frame	4188	4382	4616	4772	5044	5238	5588	5976	6480	6946	4426	6596	7926	11986	7.75	140	-

**DIMENSIONS**



Height: **720mm (28")**  
 Width: **800mm (31")**  
 Depth: **850mm (33")**

### 2 SEAT ARMLESS UNIT

Code:	Description	COM /1	2	3	4	5	6	7	8	9	10	COL	L1	L2	L3	(ly)	(ft²)	(lb)
 <b>ORT/11</b>	2 seat Armless Unit, with Oak legs	5642	5918	6248	6468	6854	7130	7626	8176	8892	9552	5978	9048	10928	16670	11.00	198	-
<b>ORT/11/B</b>	2 seat Armless Unit, with ABW legs	5966	6242	6572	6792	7178	7454	7950	8500	9216	9876	6306	9376	11256	16998	11.00	198	-
 <b>ORT/11/H</b>	2 seat Armless Unit, Oak H Frame	5846	6122	6452	6672	7058	7334	7830	8380	9096	9756	6184	9254	11134	16876	11.00	198	-
<b>ORT/11/HB</b>	2 seat Armless Unit, with ABW H Frame	6156	6432	6762	6982	7368	7644	8140	8690	9406	10066	6498	9568	11448	17190	11.00	198	-

**DIMENSIONS**

Height: **720mm (28")**  
 Width: **1600mm (63")**  
 Depth: **850mm (33")**

3 SEAT ARMLESS UNIT	Code:	Description	COM /1	2	3	4	5	6	7	8	9	10	COL	L1	L2	L3	(ly)	(ft <sup>2</sup> )	(lb)
	<b>ORT/12</b>	3 seat Armless Unit, with Oak legs (As Shown)	7208	7596	8062	8372	8916	9304	10002	10778	11786	12716	7672	11998	14648	22738	15.50	279	-
	<b>ORT/12/B</b>	3 seat Armless Unit, with ABW legs	7352	7740	8206	8516	9060	9448	10146	10922	11930	12860	7818	12144	14794	22884	15.50	279	-
	<b>ORT/12/H</b>	3 seat Armless Unit, with Oak H Frame (As Shown)	7450	7838	8304	8614	9158	9546	10244	11020	12028	12958	7918	12244	14894	22984	15.50	279	-
<b>DIMENSIONS</b> Height: <b>720mm (28")</b> Width: <b>2100mm (83")</b> Depth: <b>850mm (33")</b> Seat Height: <b>430mm (17")</b>	<b>ORT/12/HB</b>	3 seat Armless Unit, with ABW H Frame	7608	7996	8462	8772	9316	9704	10402	11178	12186	13116	8076	12402	15052	23142	15.50	279	-

LOUNGE & MODULAR SEATING SYSTEMS



ORT/7/H RH, ORT/4/H, ORT/7/H LH

# Orten Wide Arm

boss

Lounge Seating



Standard Orten Armchair







Orten Wide Arm Armchair

## Range Information

- Timber underframe available in Oak, American Black Walnut or to a painted finish (painted finish is \$236)
- Top stitch detail
- CMHR foam and feather seat and back cushions
- Webbed seat support
- Loose seat cushions, loose back cushions
- A full range of line drawings and images in the Orten Wide Arm range can be downloaded from our website [bossdesign.com](http://bossdesign.com)
- Not recommended to be upholstered in Graded 1 fabrics







**ARMCHAIR**

	Code:	Description	COM /1	2	3	4	5	6	7	8	9	10	COL	L1	L2	L3	 (ly)	 (ft <sup>2</sup> )	 (lb)
	<b>ORT/1/ WA/OAK</b>	Orten Wide Arm armchair with Oak legs (As Shown)	4090	4284	4518	4674	4946	5140	5490	5878	6382	6848	4328	6498	7828	11888	7.75	140	
	<b>ORT/1/ WA/ABW</b>	Orten Wide Arm armchair with ABW legs	4158	4352	4586	4742	5014	5208	5558	5946	6450	6916	4396	6566	7896	11956	7.75	140	
	<b>ORT/1/ WA/H/ OAK</b>	Orten Wide Arm armchair with Oak H-Frame	4156	4350	4584	4740	5012	5206	5556	5944	6448	6914	4394	6564	7894	11954	7.75	140	
	<b>ORT/1/ WA/H/ ABW</b>	Orten Wide Arm armchair with ABW H-Frame	4266	4460	4694	4850	5122	5316	5666	6054	6558	7024	4506	6676	8006	12066	7.75	140	

**DIMENSIONS**  
 Height: **720mm (28.25")**  
 Width: **1020mm (40")**  
 Depth: **850mm (33")**

LOUNGE SEATING

**TWO SEAT SOFA**

	Code:	Description	COM /1	2	3	4	5	6	7	8	9	10	COL	L1	L2	L3	 (ly)	 (ft <sup>2</sup> )	 (lb)
	<b>ORT/2/ WA/OAK</b>	Orten Wide Arm 2 seat sofa with Oak legs (As Shown)	5816	6104	6450	6680	7084	7372	7890	8466	9214	9904	6166	9376	11342	17344	11.50	207	
	<b>ORT/2/ WA/ABW</b>	Orten Wide Arm 2 seat sofa with ABW legs	6262	6550	6896	7126	7530	7818	8336	8912	9660	10350	6616	9826	11792	17794	11.50	207	
	<b>ORT/2/ WA/H/ OAK</b>	Orten Wide Arm 2 seat sofa with Oak H-Frame	6010	6298	6644	6874	7278	7566	8084	8660	9408	10098	6362	9572	11538	17540	11.50	207	
	<b>ORT/2/ WA/H/ ABW</b>	Orten Wide Arm 2 seat sofa with ABW H-Frame	6456	6744	7090	7320	7724	8012	8530	9106	9854	10544	6812	10022	11988	17990	11.50	207	

**DIMENSIONS**  
 Height: **720mm (28.25")**  
 Width: **1920mm (76")**  
 Depth: **850mm (33")**

N.B. Leather is a natural material which will crease and 'puddle'.

 Fabric Linear Yard  Leather Square Footage  Product Weight



## Range Information

- Hardwood & plywood internal frame
- CMHR foams throughout
- A full range of line drawings and images in the Vernon range can be downloaded from our website [bossdesign.com](http://bossdesign.com)
- Not recommended to be upholstered in Grade 1 fabrics



**ARMCHAIR**

	Code:	Description	COM /1	2	3	4	5	6	7	8	9	10	COL	L1	L2	L3	(ly)	(ft <sup>2</sup> )	(lb)
 <p><b>DIMENSIONS</b>                      Height: <b>900mm (35")</b>                      Width: <b>780mm (31")</b>                      Depth: <b>920mm (36")</b>                      Seat Height: <b>400mm (15.75")</b></p>	<b>VER/1/OAK</b>	Vernon armchair Oak legs	3036	3230	3464	3620	3892	4086	4436	4824	5328	5794	3264	5434	6764	10824	7.75	140	-
	<b>VER/1/ABW</b>	Vernon armchair American Black Walnut legs	3124	3318	3552	3708	3980	4174	4524	4912	5416	5882	3352	5522	6852	10912	7.75	140	-

**COMPACT SOFA**

	Code:	Description	COM /1	2	3	4	5	6	7	8	9	10	COL	L1	L2	L3	(ly)	(ft <sup>2</sup> )	(lb)
 <p><b>DIMENSIONS</b>                      Height: <b>900mm (35")</b>                      Width: <b>1500mm (59")</b>                      Depth: <b>920mm (36")</b>                      Seat Height: <b>400mm (15.75")</b></p>	<b>VER/2/OAK</b>	Vernon compact sofa Oak legs	4902	5290	5756	6066	6610	6998	7696	8472	9480	10410	5344	9670	12320	20410	15.50	279	-
	<b>VER/2/ABW</b>	Vernon compact sofa American Black Walnut legs	4990	5378	5844	6154	6698	7086	7784	8560	9568	10498	5432	9758	12408	20498	15.50	279	-

LOUNGE SEATING

**LARGE SOFA**

	Code:	Description	COM /1	2	3	4	5	6	7	8	9	10	COL	L1	L2	L3	(ly)	(ft <sup>2</sup> )	(lb)
 <p><b>DIMENSIONS</b>                      Height: <b>900mm (35")</b>                      Width: <b>780mm (31")</b>                      Depth: <b>2150mm (85")</b>                      Seat Height: <b>400mm (15.75")</b></p>	<b>VER/3/OAK</b>	Vernon large sofa Oak legs	5838	6252	6748	7078	7656	8070	8814	9640	10714	11704	6316	10920	13742	22354	16.50	297	-
	<b>VER/3/ABW</b>	Vernon large sofa American Black Walnut legs	5926	6340	6836	7166	7744	8158	8902	9728	10802	11792	6404	11008	13830	22442	16.50	297	-



02.

**Chairs &  
Stools**

Agent  
Chairs & Stools Collection

boss



Agent is a collection of chairs, stools, benches and tables with versatility at its core. Robust and refined, these hard-working pieces are as agile as they are functional. Ideal for meetings, boardrooms and breakout areas.

Available in American Black Walnut or Oak, personalize with painted frames in a range of colors.



CHAIRS & STOOLS





### Range Information

- Collection includes dining chair, lounge chair, bar stool, bench and stool.
- Fixed CMHR foam seat and back
- Top stitch detail
- Timber Underframe available in Oak, American Black Walnut or to a painted finish (painted finish is \$236).
- We recommend prior leather and fabric approval to ensure the highest quality finish.



**DINING CHAIR**

Code:	Description	COM /1	2	3	4	5	6	7	8	9	10	COL	L1	L2	L3	(ly)	(ft²)	(lb)
<b>AGE/1</b>	Agent Dining Chair, Oak Frame	838	870	908	934	978	1010	1068	1132	1214	1290	880	1238	1456	2122	1.25	23	
<b>AGE/4</b>	Agent Dining Chair, ABW frame	898	930	968	994	1038	1070	1128	1192	1274	1350	940	1298	1516	2182	1.25	23	



**DIMENSIONS**

Height: **840mm (33")**  
 Width: **500mm (20")**  
 Depth: **560mm (22")**  
 Seat Height: **460mm (18")**

**DINING CHAIR - ARMS**

Code:	Description	COM /1	2	3	4	5	6	7	8	9	10	COL	L1	L2	L3	(ly)	(ft²)	(lb)
<b>AGE/7</b>	Agent Dining Chair with Arms, Oak Frame	1276	1308	1346	1372	1416	1448	1506	1570	1652	1728	1322	1680	1898	2564	1.25	23	
<b>AGE/8</b>	Agent Dining Chair with Arms, ABW Frame	1378	1410	1448	1474	1518	1550	1608	1672	1754	1830	1426	1784	2002	2668	1.25	23	



**DIMENSIONS**

Height: **840mm (33")**  
 Width: **560mm (22")**  
 Depth: **560mm (22")**  
 Seat Height: **460mm (18")**  
 Arm Height: **660mm (26")**

**LOUNGE CHAIR**

Code:	Description	COM /1	2	3	4	5	6	7	8	9	10	COL	L1	L2	L3	(ly)	(ft²)	(lb)
<b>AGE/2</b>	Agent Lounge Chair, Oak Frame	1120	1158	1204	1234	1288	1326	1394	1470	1568	1658	1170	1590	1846	2628	1.50	27	
<b>AGE/5</b>	Agent Lounge Chair, ABW Frame	1184	1222	1268	1298	1352	1390	1458	1534	1632	1722	1236	1656	1912	2694	1.50	27	



**DIMENSIONS**

Height: **720mm (28")**  
 Width: **600mm (24")**  
 Depth: **700mm (28")**  
 Seat Height: **400mm (15.75")**

CHAIRS & STOOLS

N.B. Leather is a natural material which will crease and 'puddle'.

Fabric Linear Yard Leather Square Footage Product Weight

## LOUNGE CHAIR - ARMS

Code:	Description	COL /1	2	3	4	5	6	7	8	9	10	COL	L1	L2	L3	(ly)	(ft²)	(lb)
<b>AGE/27</b>	Agent Lounge Chair with Arms, Oak Frame	1648	1686	1732	1762	1816	1854	1922	1998	2096	2186	1704	2124	2380	3162	1.50	27	
<b>AGE/28</b>	Agent Lounge Chair with Arms, ABW Frame	1808	1846	1892	1922	1976	2014	2082	2158	2256	2346	1866	2286	2542	3324	1.50	27	



### DIMENSIONS

Height: **720mm (28.25")**  
 Width: **670mm (26.5")**  
 Depth: **700mm (27.5")**  
 Seat Height: **400mm (15.75")**  
 Arm Height: **560mm (22")**

## BAR STOOL

Code:	Description	COL /1	2	3	4	5	6	7	8	9	10	COL	L1	L2	L3	(ly)	(ft²)	(lb)
<b>AGE/3</b>	Agent Bar Stool, Oak Frame	1274	1300	1330	1350	1386	1412	1458	1508	1574	1634	1314	1594	1764	2286	1.00	18	
<b>AGE/6</b>	Agent Bar Stool, ABW Frame	1444	1470	1500	1520	1556	1582	1628	1678	1744	1804	1486	1766	1936	2458	1.00	18	
<b>AGE/3CH /OAK</b>	Agent Bar Stool Counter Height, Oak Frame	1274	1300	1330	1350	1386	1412	1458	1508	1574	1634	1314	1594	1764	2286	1.00	18	
<b>AGE/6CH /ABW</b>	Agent Bar Stool Counter Height, ABW Frame	1444	1470	1500	1520	1556	1582	1628	1678	1744	1804	1486	1766	1936	2458	1.00	18	



### DIMENSIONS

Height: **930mm (36.5")**  
 Width: **420mm (17")**  
 Depth: **490mm (19")**  
 Seat Height: **750mm (29.5")**  
 Foot rail height: **280mm (11")**  
 Counter Height: **840mm (33")**  
 Seat height: **660mm (26")**  
 Foot Rail: **190mm (7.5")**

## LOW STOOL

Code:	Description	COL /1	2	3	4	5	6	7	8	9	10	COL	L1	L2	L3	(ly)	(ft²)	(lb)
<b>AGE/35</b>	Agent Low Stool, Oak Frame	742	762	786	802	830	850	884	922	972	1018	770	988	1120	1526	0.75	14	
<b>AGE/36</b>	Agent Low Stool ABW Frame	790	810	834	850	878	898	932	970	1020	1066	820	1038	1170	1576	0.75	14	





### DIMENSIONS

Height: **450mm (18")**  
 Width: **440mm (17")**  
 Depth: **440mm (17")**

N.B. Leather is a natural material which will crease and 'puddle'.

Fabric Linear Yards Leather Square Footage Product Weight

1700 BENCH	Code:	Description	COL /1	2	3	4	5	6	7	8	9	10	COL	L1	L2	L3	(ly)	(ft²)	(lb)
 <p><b>DIMENSIONS</b> Height: <b>440mm (17")</b> Width: <b>1700mm (67")</b> Depth: <b>400mm (16")</b></p>	AGE/21	67" Bench with Oak Frame	1598	1636	1682	1712	1766	1804	1872	1948	2046	2136	1654	2074	2330	3112	1.50	27	
	AGE/22	67" Bench with ABW Frame	1890	1928	1974	2004	2058	2096	2164	2240	2338	2428	1948	2368	2624	3406	1.50	27	

1900 BENCH	Code:	Description	COL /1	2	3	4	5	6	7	8	9	10	COL	L1	L2	L3	(ly)	(ft²)	(lb)
 <p><b>DIMENSIONS</b> Height: <b>440mm (17")</b> Width: <b>1900mm (75")</b> Depth: <b>400mm (16")</b></p>	AGE/23	75" Bench with Oak Frame	1614	1652	1698	1728	1782	1820	1888	1964	2062	2152	1670	2090	2346	3128	1.50	27	
	AGE/24	75" Bench with ABW Frame	1890	1928	1974	2004	2058	2096	2164	2240	2338	2428	1948	2368	2624	3406	1.50	27	

2100 BENCH	Code:	Description	COL /1	2	3	4	5	6	7	8	9	10	COL	L1	L2	L3	(ly)	(ft²)	(lb)
 <p><b>DIMENSIONS</b> Height: <b>440mm (17")</b> Width: <b>2100mm (83")</b> Depth: <b>400mm (16")</b></p>	AGE/25	83" Bench with Oak Frame	1672	1710	1756	1786	1840	1878	1946	2022	2120	2210	1728	2148	2404	3186	1.50	27	
	AGE/26	83" Bench with ABW Frame	1894	1932	1978	2008	2062	2100	2168	2244	2342	2432	1952	2372	2628	3410	1.50	27	

N.B. Leather is a natural material which will crease and 'puddle'.

# Amelia

Lounge Chair Collection

boss





CHAIRS







## Range Information



- Amelia Lounge chair is available in two styles:  
Standard Upholstery(AME)  
Plush Upholstery (ALP)
- Available with a variety of base frames: Steel four leg, Steel sled, Aluminum four star and Oak four star base
- Oak timber four star with clear lacquer is also available. This can also be stained to a black or white finish
- Metal base frames available in any of the standard 8 Boss RAL colors.
- **The only approved leather for Amelia is the Green Hides Lena - Band L2**
- For customers own fabric/leather, please contact us so we can advise on suitability
- **Please Note:**  
Leather option only available on Plush models



AME/1 LOUNGE CHAIR WITH STEEL FOUR-LEG BASE	Code:	Description	COM /1	2	3	4	5	6	7	8	9	10	COL	L1	L2	L3	(ly)	(ft <sup>2</sup> )	(lb)
 <p><b>DIMENSIONS</b>            Height: 1055mm (41.5")            Width: 805mm (31.75")            Depth: 910mm (35.75")            Seat Height: 420mm (16.5")            Seat Depth: 550mm (21.75")</p>	AME/1	Amelia lounge chair with steel four leg base	3376	3476	3596	3676	3816	3916	4096	4296	4556	4796	3512	-	-	-	4.00		

AME/2 LOUNGE CHAIR WITH SLED BASE	Code:	Description	COM /1	2	3	4	5	6	7	8	9	10	COL	L1	L2	L3	(ly)	(ft <sup>2</sup> )	(lb)
 <p><b>DIMENSIONS</b>            Height: 1055mm (41.5")            Width: 805mm (31.75")            Depth: 910mm (35.75")            Seat Height: 420mm (16.5")            Seat Depth: 550mm (21.75")</p>	AME/2	Amelia lounge chair with steel sled base	3434	3534	3654	3734	3874	3974	4154	4354	4614	4854	3570	-	-	-	4.00		

CHAIRS

 Fabric Linear Yard
  Leather Square Footage
  Product Weight

**AME/ 1 & AME/2 - Painted Base Options**

Color Choice	RAL 9005	RAL 9016	RAL 060 60 05	RAL 240 20 22	RAL 220 70 10	RAL 130 30 20	RAL 040 50 50	RAL 070 70 80
Suffix*	PF/B	PF/W	PF/SG	PF/DB	PF/LB	PF/GN	PF/CR	PF/Y
\$	\$inc	\$inc	\$inc	\$inc	\$inc	\$inc	\$inc	\$inc

**AME/4  
LOUNGE CHAIR WITH  
ALUMINUM FOUR STAR BASE**

Code:	Description	COM /1	2	3	4	5	6	7	8	9	10	COL	L1	L2	L3	(ly)	(ft²)	(lb)
AME/4	Amelia lounge chair with Aluminum four star base	3552	3652	3772	3852	3992	4092	4272	4472	4732	4972	3690	-	-	-	4.00		



**DIMENSIONS**

Height: 1055mm (41.5")  
 Width: 805mm (31.75")  
 Depth: 910mm (35.75")  
 Seat Height: 420mm (16.5")  
 Seat Depth: 550mm (21.75")

**AME/4/OAK  
LOUNGE CHAIR WITH OAK  
FOUR STAR BASE**

Code:	Description	COM /1	2	3	4	5	6	7	8	9	10	COL	L1	L2	L3	(ly)	(ft²)	(lb)
AME/4/OAK	Amelia lounge chair with Oak four star base	4502	4602	4722	4802	4942	5042	5222	5422	5682	5922	4650	-	-	-	4.00		



**DIMENSIONS**

Height: 1055mm (41.5")  
 Width: 805mm (31.75")  
 Depth: 910mm (35.75")  
 Seat Height: 420mm (16.5")  
 Seat Depth: 550mm (21.75")

Fabric Linear Yard Leather Square Footage Product Weight

**AME/4 - Painted Frame Options**

Color Choice	RAL 9005	RAL 9016	RAL 060 60 05	RAL 240 20 22	RAL 220 70 10	RAL 130 30 20	RAL 040 50 50	RAL 070 70 80
Suffix*	PF/B	PF/W	PF/SG	PF/DB	PF/LB	PF/GN	PF/CR	PF/Y
\$	160	160	160	160	160	160	160	160

**AME/4/OAK - Options**

CODE:	DESCRIPTION	\$
MEMORY RETURN	Memory Return Swivel Mechanism AME/4/OAK	60



CHAIRS

**ALP/1  
PLUSH LOUNGE CHAIR WITH  
STEEL FOUR-LEG BASE**

Code:	Description	COM /1	2	3	4	5	6	7	8	9	10	COL	L1	L2	L3	(ly)	(ft²)	(lb)
ALP/1	Amelia Lounge Plush chair with steel four leg base	3590	3700	3832	3920	4074	4184	4382	4602	4888	5152	3738	-	6946	-	4.40	79	



**DIMENSIONS**

Height: 1055mm (41.5")  
 Width: 805mm (31.75")  
 Depth: 910mm (35.75")  
 Seat Height: 420mm (16.5")  
 Seat Depth: 550mm (21.75")

**ALP/2  
PLUSH LOUNGE CHAIR WITH  
SLED BASE**

Code:	Description	COM /1	2	3	4	5	6	7	8	9	10	COL	L1	L2	L3	(ly)	(ft²)	(lb)
ALP/2	Amelia Lounge Plush chair with steel sled base	3648	3758	3890	3978	4132	4242	4440	4660	4946	5210	3796	-	7004	-	4.40	79	



**DIMENSIONS**





Height: 1055mm (41.5")  
 Width: 805mm (31.75")  
 Depth: 910mm (35.75")  
 Seat Height: 420mm (16.5")  
 Seat Depth: 550mm (21.75")





N.B. Leather is a natural material which will crease and 'puddle'.

Fabric Linear Yard Leather Square Footage Product Weight

**ALP/ 1 & ALP/2 - Painted Base Options**

Color Choice	RAL 9005	RAL 9016	RAL 060 60 05	RAL 240 20 22	RAL 220 70 10	RAL 130 30 20	RAL 040 50 50	RAL 070 70 80
Suffix*	PF/B	PF/W	PF/SG	PF/DB	PF/LB	PF/GN	PF/CR	PF/Y
\$	\$inc	\$inc	\$inc	\$inc	\$inc	\$inc	\$inc	\$inc

<b>ALP/4 PLUSH LOUNGE CHAIR WITH ALUMINUM FOUR STAR BASE</b>	<b>Code:</b>	<b>Description</b>	<b>COM</b> /1	2	3	4	5	6	7	8	9	10	COL	L1	L2	L3	 (ly)	 (ft <sup>2</sup> )	 (lb)
	<b>ALP/4</b>	Amelia Lounge Plush chair with Aluminum four star base	3762	3872	4004	4092	4246	4356	4554	4774	5060	5324	3912	-	7120	-	4.40	79	
<b>DIMENSIONS</b> Height: <b>1055mm (41.5")</b> Width: <b>805mm (31.75")</b> Depth: <b>910mm (35.75")</b> Seat Height: <b>420mm (16.5")</b> Seat Depth: <b>550mm (21.75")</b>																			

<b>ALP/4/OAK PLUSH LOUNGE CHAIR WITH OAK FOUR STAR BASE</b>	<b>Code:</b>	<b>Description</b>	<b>COM</b> /1	2	3	4	5	6	7	8	9	10	COL	L1	L2	L3	 (ly)	 (ft <sup>2</sup> )	 (lb)
	<b>ALP/4/OAK</b>	Amelia Lounge Plush chair with Oak four star base	4712	4822	4954	5042	5196	5306	5504	5724	6010	6274	4872	-	8080	-	4.40	79	
<b>DIMENSIONS</b> Height: <b>1055mm (41.5")</b> Width: <b>805mm (31.75")</b> Depth: <b>910mm (35.75")</b> Seat Height: <b>420mm (16.5")</b> Seat Depth: <b>550mm (21.75")</b>																			

CHAIRS

N.B. Leather is a natural material which will crease and 'puddle'.

 Fabric Linear Yard  Leather Square Footage  Product Weight

### ALP/4 - Metal Painted Frame Options

Color Choice	RAL 9005	RAL 9016	RAL 060 60 05	RAL 240 20 22	RAL 220 70 10	RAL 130 30 20	RAL 040 50 50	RAL 070 70 80
Suffix*	PF/B	PF/W	PF/SG	PF/DB	PF/LB	PF/GN	PF/CR	PF/Y
+\$	160	160	160	160	160	160	160	160

### ALP/4/OAK - Options

CODE:	DESCRIPTION	\$
<b>MEMORY RETURN</b>	Memory Return Swivel Mechanism ALP/4/OAK	60

# Arran

Chairs & Stools

boss



The Arran range combines style and versatility, catering for the broad requirements of the modern workplace. With a sleek profile, the comfortable and fully upholstered stackable chair is available with or without arms and presents an adaptable

meeting, visitor or bar stool option. The option of a quilted stitch detail adds a relaxed design element. The chair and accompanying bar stool are available with either a skid or 4-legged frame. The chair may also be specified with a 5-star base with castors.





## Range Information

- Fully upholstered in fabric or leather
- CMHR seat and back foams
- Available with a 4 leg base, 4 star base or sled base
- Twin-needle stitch detail as standard
- Stackable 4 high - 4 leg and sled (non arm sled only)
- Arms with plastic pad only available on sled base chair
- Chrome arms available on four leg, skid base, 4 star and 5 star
- Painted frame options available on 4 leg, 4 star and sled base.



**ARR/1  
4 LEG FRAME**

Code:

Description

COL /1 2 3 4 5 6 7 8 9 10 COL L1 L2 L3

(ly) (ft<sup>2</sup>) (lb)



ARR/1

Arran chair chrome 4-leg

632 658 688 708 744 770 816 866 932 992 666 946 1116 1638

1.00 18

ARR/1/CA

Arran chair chrome 4-leg Chrome Arms

742 768 798 818 854 880 926 976 1042 1102 776 1056 1226 1748

1.00 18

**DIMENSIONS**

Height: **790mm (31")**  
Width: **540mm (21")**  
Depth: **530mm (21")**  
Seat Height: **42" (18")**

**Painted Frame Options**

Color Choice	RAL 9005	RAL 9016	RAL 060 60 05	RAL 240 20 22	RAL 220 70 10	RAL 130 30 20	RAL 040 50 50	RAL 070 70 80
Suffix*	PF/B	PF/W	PF/SG	PF/DB	PF/LB	PF/GN	PF/CR	PF/Y
\$	100	100	100	100	100	100	100	100

**ARR/2  
SLED BASE**

Code:

Description

COL /1 2 3 4 5 6 7 8 9 10 COL L1 L2 L3

(ly) (ft<sup>2</sup>) (lb)



ARR/2

Arran chair chrome skid base

680 706 736 756 792 818 864 914 980 1040 714 994 1164 1686

1.00 18

ARR/2/PA

Arran chair chrome skid base, plastic arm

776 802 832 852 888 914 960 1010 1076 1136 812 1092 1262 1784

1.00 18

ARR/2/LA

Arran chair chrome skid base, loop arm

766 792 822 842 878 904 950 1000 1066 1126 800 1080 1250 1772

1.00 18

**DIMENSIONS**

Height: **790mm (31")**  
Width: **540mm (21")**  
Depth: **530mm (21")**  
Seat Height: **42" (18")**

CHAIRS & STOOLS

N.B. Leather is a natural material which will crease and 'puddle'.

Fabric Linear Yard Leather Square Footage Product Weight

**Painted Frame Options**

Color Choice	RAL 9005	RAL 9016	RAL 060 60 05	RAL 240 20 22	RAL 220 70 10	RAL 130 30 20	RAL 040 50 50	RAL 070 70 80
Suffix*	PF/B	PF/W	PF/SG	PF/DB	PF/LB	PF/GN	PF/CR	PF/Y
\$	100	100	100	100	100	100	100	100

**ARR/4**  
4 STAR BASE

**Code:**      **Description**      COL   2   3   4   5   6   7   8   9   10   COL   L1   L2   L3

(ly)   (ft²)   (lb)



**ARR/4**      Arran swivel 4-star base      912   938   968   988   1024   1050   1096   1146   1212   1272   948   1228   1398   1920   1.00   18

**DIMENSIONS**

Height: **800 (32")**  
Width: **460mm (18")**  
Depth: **52197"m (21")**  
Seat Height: **430mm (17")**  
Seat Depth: **420mm (17")**

**Painted Frame Options**

Color Choice	RAL 9005	RAL 9016	RAL 060 60 05	RAL 240 20 22	RAL 220 70 10	RAL 130 30 20	RAL 040 50 50	RAL 070 70 80
Suffix*	PF/B	PF/W	PF/SG	PF/DB	PF/LB	PF/GN	PF/CR	PF/Y
\$	160	160	160	160	160	160	160	160

**ARR/5**  
5 STAR BASE CASTORS

**Code:**      **Description**      COL   2   3   4   5   6   7   8   9   10   COL   L1   L2   L3

(ly)   (ft²)   (lb)



**ARR/5**      Arran swivel 5-star base      644   670   700   720   756   782   828   878   944   1004   678   958   1128   1650   1.00   18

**ARR/5/CA**      Arran swivel 5-star base, chrome arm      754   780   810   830   866   892   938   988   1054   1114   788   1068   1238   1760   1.00   18

**DIMENSIONS**

Height: **760-880mm (")**  
Width: **460mm (18")**  
Depth: **61.4" ("25)**  
Seat Height: **390-510mm (16-20")**  
Seat Depth: **420mm (17")**

N.B. Leather is a natural material which will crease and 'puddle'.

Fabric Linear Yard   Leather Square Footage   Product Weight

**ARR/6  
4 LEG STOOL**



**DIMENSIONS**  
 Height: **115mm (44")**  
 Width: **510mm (20")**  
 Depth: **555mm (22")**  
 Seat Height: **760mm (30")**

Code:	Description	COL /1	2	3	4	5	6	7	8	9	10	COL	L1	L2	L3	(ly)	(ft <sup>2</sup> )	(lb)
<b>ARR/6</b>	Arran stool chrome 4-leg	780	806	836	856	892	918	964	1014	1080	1140	816	1096	1266	1788	1.00	18	
<b>ARR/6/CH</b>	Arran counter height stool chrome 4-leg	780	806	836	856	892	918	964	1014	1080	1140	816	1096	1266	1788	1.00	18	

**ARR/7  
SKID FRAME STOOL**



**DIMENSIONS**  
 Height: **11197"m (44")**  
 Width: **51197"m (20")**  
 Depth: **54197"m (21")**  
 Seat Height: **760mm (30")**

Code:	Description	COL /1	2	3	4	5	6	7	8	9	10	COL	L1	L2	L3	(ly)	(ft <sup>2</sup> )	(lb)
<b>ARR/7</b>	Arran stool chrome skid base	790	816	846	866	902	928	974	1024	1090	1150	826	1106	1276	1798	1.00	18	

N.B. Leather is a natural material which will crease and 'puddle'.

Fabric Linear Yard Leather Square Footage Product Weight

**Painted Frame Options**

Color Choice	RAL 9005	RAL 9016	RAL 060 60 05	RAL 240 20 22	RAL 220 70 10	RAL 130 30 20	RAL 040 50 50	RAL 070 70 80
Suffix*	PF/B	PF/W	PF/SG	PF/DB	PF/LB	PF/GN	PF/CR	PF/Y
\$	100	100	100	100	100	100	100	100



## Range Information

- Collection includes Stool and Ottoman
- Twin stitch detail
- Available in fabric or leather upholstery
- Two-tone options available (POA)
- Plywood internal frame
- CMHR foam
- Base plinth: Oak, ABW or to a painted finish (painted finish upcharge is \$236 per color, per order)
- Nylon glides as standard
- Swivel Castors also available (see Options)



**BRIM/1  
LOW STOOL**

Code:	Description	COM /1	2	3	4	5	6	7	8	9	10	COL	L1	L2	L3	(ly)	(ft²)	(lb)
<b>BRI/1/ OAK</b>	Brimm Stool with Oak base plinth, upholstered seat (as shown)	1030	1068	1114	1144	1198	1236	1304	1380	1478	1568	1080	1500	1756	2538	1.50	27	
<b>BRI/T1/ OAK/ OAKTOP</b>	Brimm Stool with Oak base plinth, Oak top (as shown)	1096	1134	1180	1210	1264	1302	1370	1446	1544	1634	1146	1566	1822	2604	1.50	27	
<b>BRI/1/ ABW</b>	Brimm Stool with ABW base plinth, upholstered seat (as shown)	1030	1068	1114	1144	1198	1236	1304	1380	1478	1568	1080	1500	1756	2538	1.50	27	
<b>BRI/T1/ ABW/ ABWTOP</b>	Brimm Stool with ABW base plinth, ABW top	1104	1142	1188	1218	1272	1310	1378	1454	1552	1642	1154	1574	1830	2612	1.50	27	



**DIMENSIONS**  
Height: 480mm (19")  
Base Width: 525mm (20.75")

**BRIM/2  
OTTOMAN STOOL**

Code:	Description	COM /1	2	3	4	5	6	7	8	9	10	COL	L1	L2	L3	(ly)	(ft²)	(lb)
<b>BRI/2/ OAK</b>	Brimm Ottoman with Oak base plinth, upholstered seat (as shown)	2158	2228	2312	2368	2466	2536	2660	2798	2978	3144	2252	3028	3502	4952	2.75	50	
<b>BRI/T2/ OAK/ OAKTOP</b>	Brimm Ottoman with Oak base plinth, Oak top (as shown)	2348	2418	2502	2558	2656	2726	2850	2988	3168	3334	2444	3220	3694	5144	2.75	50	
<b>BRI/2/ ABW</b>	Brimm Ottoman with ABW base plinth, upholstered seat (as shown)	2158	2228	2312	2368	2466	2536	2660	2798	2978	3144	2252	3028	3502	4952	2.75	50	
<b>BRI/T2/ ABW/ ABWTOP</b>	Brimm Ottoman with ABW base plinth, ABW top	2372	2442	2526	2582	2680	2750	2874	3012	3192	3358	2468	3244	3718	5168	2.75	50	



**DIMENSIONS**  
Height: 400mm (15.75")  
Base Width: 1050mm (41.25")

STOOLS

**Options**

Fabric Linear Yard Leather Square Footage Product Weight

CODE:	DESCRIPTION	\$
<b>STCA</b>	Stool - Castors	220
<b>OTCA</b>	Ottoman - Castors	258



# Callisto

Lounge Chairs & Stools Collection

boss



The Callisto collection offers crisp contemporary lines and reassuring comfort, with a respectful hint of 1950's retro cool. These versatile designs possess a timeless appeal that will complement any interior.



CHAIRS & STOOLS



## Range Information

- Hardwood and plywood internal frame
- CMHR foam and fiber seat
- Fixed CMHR foam back
- Webbed seat and back construction
- Top stitch quilted detail
- Timber: American Black Walnut or Oak
- Option of a painted frame, in any RAL color
- Standard Finish: Clear lacquer
- A full range of line drawings and images in the Callisto range can be downloaded from our website [bossdesign.com](http://bossdesign.com)
- Timber Underframe available in Oak, American Black Walnut or to a painted finish (painted finish is \$236)
- Not recommended to be upholstered in Grade 1 fabrics



**CAL/1/  
ARMCHAIR**

Code:	Description	COM /1	2	3	4	5	6	7	8	9	10	COL	L1	L2	L3	(ly)	(ft <sup>2</sup> )	(lb)
<b>CAL/1/ OAK</b>	Armchair in Oak	2266	2366	2486	2566	2706	2806	2986	3186	3446	3686	2390	3506	4190	6278	4.00	72	
<b>CAL/1/ ABW</b>	Armchair in ABW	2358	2458	2578	2658	2798	2898	3078	3278	3538	3778	2484	3600	4284	6372	4.00	72	



**DIMENSIONS**  
 Height: **720mm (28")**  
 Width: **720mm (28")**  
 Depth: **760mm (30")**  
 Seat Height: **380mm (15")**

**CAL/2/  
COMPACT SOFA**

Code:	Description	COM /1	2	3	4	5	6	7	8	9	10	COL	L1	L2	L3	(ly)	(ft <sup>2</sup> )	(lb)
<b>CAL/2/ OAK</b>	Compact Sofa in Oak	2890	3004	3140	3230	3388	3502	3706	3932	4226	4496	3036	4292	5062	7410	4.50	81	
<b>CAL/2/ ABW"</b>	Compact Sofa in ABW	3090	3204	3340	3430	3588	3702	3906	4132	4426	4696	3238	4494	5264	7612	4.50	81	



**DIMENSIONS**  
 Height: **720mm (28")**  
 Width: **1180mm (46")**  
 Depth: **760mm (30")**  
 Seat Height: **380mm (15")**

**CAL/3/  
LARGE SOFA**

Code:	Description	COM /1	2	3	4	5	6	7	8	9	10	COL	L1	L2	L3	(ly)	(ft <sup>2</sup> )	(lb)
<b>CAL/3/ OAK</b>	Large Sofa in Oak	2890	3004	3140	3230	3388	3502	3706	3932	4226	4496	3036	4292	5062	7410	4.50	81	
<b>CAL/3/ ABW</b>	Large Sofa in ABW (As Shown)	3426	3540	3676	3766	3924	4038	4242	4468	4762	5032	3576	4832	5602	7950	4.50	81	



**DIMENSIONS**  
 Height: **720mm (28")**  
 Width: **1520mm (60")**  
 Depth: **760mm (30")**  
 Seat Height: **380mm (15")**

CHAIRS & STOOLS

N.B. Leather is a natural material which will crease and 'puddle'.

Fabric Linear Yard Leather Square Footage Product Weight

**CAL/4/  
BARSTOOL**



**DIMENSIONS**  
 Stool Height: **960mm (38")**  
 Width: **490mm (19")**  
 Depth: **520mm (20")**  
 Seat Height: **800mm (31.5")**  
 Foot Rail Height: **380mm (15")**  
 Counter Height: **825mm (32.5")**  
 Seat Height: **660mm (26")**  
 Foot Rail: **240mm (9.5")**

Code:	Description	COM /1	2	3	4	5	6	7	8	9	10	COL	L1	L2	L3	(ly)	(ft²)	(lb)
<b>CAL/4/ OAK</b>	Barstool in Oak (As Shown)	1372	1404	1442	1468	1512	1544	1602	1666	1748	1824	1420	1778	1996	2662	1.25	23	
<b>CAL/4/ ABW</b>	Barstool in ABW (As Shown)	1454	1486	1524	1550	1594	1626	1684	1748	1830	1906	1502	1860	2078	2744	1.25	23	
<b>CAL/4/ CH/OAK</b>	Counter Height stool in Oak	1372	1404	1442	1468	1512	1544	1602	1666	1748	1824	1420	1778	1996	2662	1.25	23	
<b>CAL/4/ CH/ABW</b>	Counter Height stool in ABW	1454	1486	1524	1550	1594	1626	1684	1748	1830	1906	1502	1860	2078	2744	1.25	23	

**CAL/5/  
DINER**



**DIMENSIONS**  
 Height: **820mm (32")**  
 Width: **540mm (21")**  
 Depth: **580mm (23")**  
 Seat Height: **480mm (19")**

Code:	Description	COM /1	2	3	4	5	6	7	8	9	10	COL	L1	L2	L3	(ly)	(ft²)	(lb)
<b>CAL/5/ OAK</b>	Diner Chair in Oak (As Shown)	1954	1998	2052	2088	2150	2194	2274	2362	2476	2582	2018	2514	2818	3746	1.75	32	
<b>CAL/5/ ABW</b>	Diner Chair in ABW (As Shown)	2058	2102	2156	2192	2254	2298	2378	2466	2580	2686	2124	2620	2924	3852	1.75	32	

**CAL/6/  
SMALL FOOTSTOOL**







**DIMENSIONS**  
 Height: **380mm (15")**  
 Width: **42" (18")**  
 Depth: **42" (18")**

Code:	Description	COM /1	2	3	4	5	6	7	8	9	10	COL	L1	L2	L3	(ly)	(ft²)	(lb)
<b>CAL/6/ OAK</b>	Small Footstool in Oak	1014	1046	1084	1110	1154	1186	1244	1308	1390	1466	1058	1416	1634	2300	1.25	23	
<b>CAL/6/ ABW</b>	Small Footstool in ABW	1098	1130	1168	1194	1238	1270	1328	1392	1474	1550	1142	1500	1718	2384	1.25	23	



N.B. Leather is a natural material which will crease and 'puddle'.



Fabric Linear Yard Leather Square Footage Product Weight

<b>CAL/7/ LARGE FOOTSTOOL</b>	Code:	Description	COM	2	3	4	5	6	7	8	9	10	COL	L1	L2	L3			
			/1														(ly)	(ft²)	(lb)
	<b>CAL/7/ OAK</b>	Large footstool in Oak	1188	1220	1258	1284	1328	1360	1418	1482	1564	1640	1234	1592	1810	2476	1.25	23	
	<b>CAL/7/ ABW</b>	Large footstool in ABW	1304	1336	1374	1400	1444	1476	1534	1598	1680	1756	1350	1708	1926	2592	1.25	23	

**DIMENSIONS**  
 Height: 380mm (15")  
 Width: 640mm (25")  
 Depth: 640mm (25")



N.B. Leather is a natural material which will crease and 'puddle'.

 Fabric Linear Yard  Leather Square Footage  Product Weight

<b>CAL/8/ LOW TABLE</b>	Code:	Description		\$	
					(lb)
	<b>CAL/8/ OAK</b>	Low Table in Oak		1146	
	<b>CAL/8/ ABW</b>	Low Table in ABW		1454	

**DIMENSIONS**  
 Height: 760mm (30")  
 Width: 760mm (30")  
 Depth: 300mm (12")

CHAIRS & STOOLS

<b>CAL/9/ OCCASIONAL TABLE</b>	Code:	Description		\$	
					(lb)
	<b>CAL/9/ OAK</b>	Occasional Table in Oak		928	
	<b>CAL/9/ ABW</b>	Occasional Table in ABW		1026	

**DIMENSIONS**  
 Height: 420mm (17")  
 Width: 500mm (20")  
 Depth: 340mm (13")

**DNA**

Lounge Seating

**boss**



DNA makes us who we are. It's in our genes. Our heritage. Ultimately our very being. And Boss Design's DNA has been the inspiration for our latest luxury executive chair.

Hand-crafted in the US, the DNA lounge chair takes our core values of innovation and quality to produce four distinct levels of comfort. Quite simply, it's the most accomplished range of upholstery we have ever produced.







LOUNGE SEATING







## Range Information

- Twin stitch detail
- Pinch stitch on back cushion
- Glides for easy reconfiguration
- Available in a wide range of fabrics and leathers
- Two-tone fabric options available
- CMHR Moulded Foam
- Steel inner framework
- Sprung Seat
- Sprung backrest
- Not recommended to be upholstered in Graded 1 fabrics



DNA/1 TUB CHAIR	Code:	Description	COM /1	2	3	4	5	6	7	8	9	10	COL	L1	L2	L3	 (ly)	 (ft²)	 (lb)
	DNA/1	DNA Tub Armchair	2996	3128	3286	3392	3576	3708	3946	4210	4552	4868	3160	4634	5536	8290	5.25	95	
<b>DIMENSIONS</b> Height: <b>840mm (33")</b> Width: <b>760mm (30")</b> Depth: <b>77197"m (30.5")</b> Seat Height: <b>440mm (17.25")</b> Arm Height: <b>600mm (23.75")</b>																			

DNA/2 TUB CHAIR	Code:	Description	COM /1	2	3	4	5	6	7	8	9	10	COL	L1	L2	L3	 (ly)	 (ft²)	 (lb)
	DNA/2	Lounge chair with polished 4 star base.	3280	3400	3544	3640	3808	3928	4142	4380	4690	4976	3434	4768	5584	8078	4.75	86	
<b>DIMENSIONS</b> Height: <b>77197"m (30.5")</b> Width: <b>760mm (30")</b> Depth: <b>77197"m (30.5")</b> Seat Height: <b>42197"m (16.75")</b> Arm Height: <b>540mm (21.25")</b>																			

LOUNGE SEATING

N.B. Leather is a natural material which will crease and 'puddle'.

 Fabric Linear Yard  Leather Square Footage  Product Weight

**Painted Swivel Base - DNA/2**

Color Choice	RAL 9005	RAL 9016	RAL 060 60 05	RAL 240 20 22	RAL 220 70 10	RAL 130 30 20	RAL 040 50 50	RAL 070 70 80
Suffix*	PF/B	PF/W	PF/SG	PF/DB	PF/LB	PF/GN	PF/CR	PF/Y
+\$	160	160	160	160	160	160	160	160

**DNA/3  
LOUNGE CHAIR TIMBER LEGS**

Code:	Description	COM /1	2	3	4	5	6	7	8	9	10	COL	L1	L2	L3	(ly)	(ft²)	(lb)
<b>DNA/3/O</b>	Lounge chair with oak legs	3448	3568	3712	3808	3976	4096	4310	4548	4858	5144	3604	4938	5754	8248	4.75	86	
<b>DNA/3/W</b>	Lounge chair with walnut legs	3660	3780	3924	4020	4188	4308	4522	4760	5070	5356	3818	5152	5968	8462	4.75	86	



**DIMENSIONS**

Height: 77197"m (30.5")  
 Width: 760mm (30")  
 Depth: 77197"m (30.5")  
 Seat Height: 42197"m (16.75")  
 Arm Height: 540mm (21.25")

**DNA/4  
TUB CHAIR WITH SLED BASE**

Code:	Description	COM /1	2	3	4	5	6	7	8	9	10	COL	L1	L2	L3	(ly)	(ft²)	(lb)
<b>DNA/4</b>	Tub Armchair on a Black or White painted Sled Base	2996	3128	3286	3392	3576	3708	3946	4210	4552	4868	3160	4634	5536	8290	4.75	86	



**DIMENSIONS**

Height: 77197"m (30.5")  
 Width: 760mm (30")  
 Depth: 77197"m (30.5")  
 Seat Height: 42197"m (16.75")  
 Arm Height: 540mm (21.25")

N.B. Leather is a natural material which will crease and 'puddle'.

Fabric Linear Yard Leather Square Footage Product Weight

**Painted Sled Base - DNA/4**

Color Choice	RAL 9005	RAL 9016	RAL 060 60 05	RAL 240 20 22	RAL 220 70 10	RAL 130 30 20	RAL 040 50 50	RAL 070 70 80
Suffix*	PF/B	PF/W	PF/SG	PF/DB	PF/LB	PF/GN	PF/CR	PF/Y
+\$	inc	inc	160	160	160	160	160	160



LOUNGE SEATING

# Happy

Lounge Chairs

boss







## Range Information

With its distinctively smooth silhouette, Happy's irresistible curves and exceptional comfort will beguile staff and visitors alike. Playful and comforting, Happy comes with either a sled or 4 star swivel base and is finished and upholstered by hand to ensure each piece is invested with uncompromising quality and craftsmanship.





- Polished aluminum 4-star swivel base
- Polished ½" diameter steel sled base
- Available with painted frames in the Boss Colors (Any RAL color available with an upcharge)
- Integral glides and swivel mechanism
- Molded foam
- CMHR foam



HY/2 SKID FRAME	Code:	Description	COM /1	2	3	4	5	6	7	8	9	10	COL	L1	L2	L3	 (ly)	 (ft²)	 (lb)
 <p><b>DIMENSIONS</b>            Height: <b>760mm (30")</b>            Width: <b>670mm (26.5")</b>            Depth: <b>630mm (24.75")</b>            Seat Height: <b>440mm (17.25")</b></p>	HY/2/FU	Polished sled base	1134	1192	1260	1306	1386	1444	1546	1660	1808	1944	1204	1840	2230	3418	2.25	41	

**Painted Frame Options**

Color Choice	RAL 9005	RAL 9016	RAL 060 60 05	RAL 240 20 22	RAL 220 70 10	RAL 130 30 20	RAL 040 50 50	RAL 070 70 80
Suffix*	PF/B	PF/W	PF/SG	PF/DB	PF/LB	PF/GN	PF/CR	PF/Y
\$	100	100	100	100	100	100	100	100

HY/4 4 STAR BASE	Code:	Description	COM /1	2	3	4	5	6	7	8	9	10	COL	L1	L2	L3	 (ly)	 (ft²)	 (lb)
 <p><b>DIMENSIONS</b>            Height: <b>760mm (30")</b>            Width: <b>670mm (26.5")</b>            Depth: <b>630mm (24.75")</b>            Seat Height: <b>440mm (17.25")</b></p>	HY/4/FU	Polished 4-star swivel base	1352	1410	1478	1524	1604	1662	1764	1878	2026	2162	1426	2062	2452	3640	2.25	41	

CHAIRS

N.B. Leather is a natural material which will crease and 'puddle'.

 Fabric Linear Yard  Leather Square Footage  Product Weight

**Painted Frame Options**

Color Choice	RAL 9005	RAL 9016	RAL 060 60 05	RAL 240 20 22	RAL 220 70 10	RAL 130 30 20	RAL 040 50 50	RAL 070 70 80
Suffix*	PF/B	PF/W	PF/SG	PF/DB	PF/LB	PF/GN	PF/CR	PF/Y
\$	160	160	160	160	160	160	160	160





## Range Information

Hoot is a versatile and playful stool. Its practical structure offers a unique aesthetic that looks at home in any reception, breakout, bar or lounge area. Hoot's distinctive design allows each stool to neatly nest together to create a multitude of configurations, including benching and individually shaped configurations.

- Fully upholstered in any fabric
- CMHR moulded foam body
- Glides are suitable for carpet and hard floors
- Stitch detail
- Not recommended to be upholstered in Graded 1 fabrics



**HOOT  
STOOL**

Code:	Description	COM /1	2	3	4	5	6	7	8	9	10	COL	L1	L2	L3	 (ly)	 (ft <sup>2</sup> )	 (lb)
<b>HOO/1</b>	Fully upholstered stool	762	794	832	858	902	934	992	1056	1138	1214	802	1160	1378	2044	1.25	23	



**DIMENSIONS**

Height: **470mm (18.5")**  
 Width: **550mm (21.75")**  
 Depth: **360mm (14.25")**

N.B. Leather is a natural material which will crease and 'puddle'.

 Fabric Linear Yard  Leather Square Footage  Product Weight

STOOLS

Isla

Chairs

boss





Boasting quality, refinement, care and passion, Isla is a refined collection of seating and tables, crafted to bring class and sophistication to any environment.



## Range Information

- Available with an Oak or American Black Walnut underframe, or Four Star Swivel Base
- Option of an armed or Non-armed Chair
- Two-tone fabric option
- Seating range available in a variety of fabrics and leathers
- Timber underframe available in a painted finish
- Fixed CMHR foam seat and back
- Top stitch detail
- A full range of line drawings and images in the Isla range can be downloaded from our website [bossdesign.com](http://bossdesign.com)
- Timber Underframe available to a painted finish (painted finish is \$236)



**ISL/1/  
DINING CHAIR WITH ARMS**

Code:	Description	COM /1	2	3	4	5	6	7	8	9	10	COL	L1	L2	L3	(ly)	(ft <sup>2</sup> )	(lb)
<b>ISL/1/ OAK</b>	Dining Chair with arms, Oak underframe (As Shown)	1908	1952	2006	2042	2104	2148	2228	2316	2430	2536	1972	2468	2772	3700	1.75	32	
<b>ISL/1/ ABW</b>	Dining Chair with arms, ABW underframe (As Shown)	2004	2048	2102	2138	2200	2244	2324	2412	2526	2632	2070	2566	2870	3798	1.75	32	



**DIMENSIONS**

Height: **835mm (33")**  
 Width: **575mm (23")**  
 Depth: **590mm (23")**  
 Seat Height: **470mm (18.5")**

CHAIRS

**ISL/2/  
DINING CHAIR NON ARM**

Code:	Description	COM /1	2	3	4	5	6	7	8	9	10	COL	L1	L2	L3	(ly)	(ft <sup>2</sup> )	(lb)
<b>ISL/2/ OAK</b>	Dining Chair Non-arm, Oak underframe (As Shown)	1866	1910	1964	2000	2062	2106	2186	2274	2388	2494	1930	2426	2730	3658	1.75	32	
<b>ISL/2/ ABW</b>	Dining Chair Non-arm, ABW underframe (As Shown)	1958	2002	2056	2092	2154	2198	2278	2366	2480	2586	2024	2520	2824	3752	1.75	32	



**DIMENSIONS**

Height: **835mm (33")**  
 Width: **575mm (23")**  
 Depth: **590mm (23")**  
 Seat Height: **470mm (18.5")**

N.B. Leather is a natural material which will crease and 'puddle'.

Fabric Linear Yard Leather Square Footage Product Weight

**ISL/3/  
DINING CHAIR WITH ARMS  
FOUR STAR BASE**



Code:	Description	COM	2	3	4	5	6	7	8	9	10	COL	L1	L2	L3	(ly)	(ft²)	(lb)
ISL/3	Dining chair with arms, polished four star base	/1	1688	1738	1798	1838	1908	1958	2048	2148	2278	2398	1756	2252	2556	3484	2.00	32

**DIMENSIONS**

Height: **835mm (22")**  
 Width: **575mm (23")**  
 Depth: **590mm (23")**  
 Seat Height: **470mm (18.5")**

**ISL/4/  
DINING CHAIR NON ARMS  
FOUR STAR BASE**



Code:	Description	COM	2	3	4	5	6	7	8	9	10	COL	L1	L2	L3	(ly)	(ft²)	(lb)
ISL/4	Dining chair non-arm polished four star base	/1	1684	1734	1794	1834	1904	1954	2044	2144	2274	2394	1752	2248	2552	3480	2.00	32

**DIMENSIONS**

Height: **835mm (22")**  
 Width: **575mm (23")**  
 Depth: **590mm (23")**  
 Seat Height: **470mm (18.5")**

N.B. Leather is a natural material which will crease and 'puddle'.

Fabric Linear Yard Leather Square Footage Product Weight





## Range Information

Fun, comfort and style sum up Jolly – a range of striking chairs perfect for lounge, reception and breakout areas. Choose from a swivel or sled base in classic black, white or aluminum as standard or add a contemporary twist and a pop of color with a painted base or contrasting upholstery.

- Polished Aluminum 4-star swivel base
- Polished 0.5" diameter steel sled base
- Integral glides and swivel mechanism
- Moulded foam
- CMHR foam



JY/1 4 STAR SWIVEL BASE	Code:	Description	COM /1	2	3	4	5	6	7	8	9	10	COL	(ly)	(ft <sup>2</sup> )	(lb)	
	JY1/FU	Polished 4-star swivel base, fully upholstered	1258	1302	1356	1392	1454	1498	1578	1666	1780	1886	-	1.75			

**DIMENSIONS**

Height: **765mm (30")**  
 Width: **600mm (23.5")**  
 Depth: **605mm (24")**  
 Seat Height: **440mm (17.25")**  
 Seat Depth: **465mm (18.25")**

N.B. Leather is a natural material which will crease and 'puddle'.

 Fabric Linear Yard  Leather Square Footage  Product Weight

**Painted Frame Options**

Color Choice	RAL 9005	RAL 9016	RAL 060 60 05	RAL 240 20 22	RAL 220 70 10	RAL 130 30 20	RAL 040 50 50	RAL 070 70 80
Suffix*	PF/B	PF/W	PF/SG	PF/DB	PF/LB	PF/GN	PF/CR	PF/Y
\$	160	160	160	160	160	160	160	160

JY/2 SKID BASE	Code:	Description	COM /1	2	3	4	5	6	7	8	9	10	COL	(ly)	(ft <sup>2</sup> )	(lb)	
	JY2/FU	Polished Skid base, fully upholstered	1036	1080	1134	1170	1232	1276	1356	1444	1558	1664	-	1.75			

**DIMENSIONS**

Height: **765mm (30")**  
 Width: **600mm (23.5")**  
 Depth: **605mm (24")**  
 Seat Height: **440mm (17.25")**  
 Seat Depth: **465mm (18.25")**

N.B. Leather is a natural material which will crease and 'puddle'.

 Fabric Linear Yard  Leather Square Footage  Product Weight

**Painted Frame Options**

Color Choice	RAL 9005	RAL 9016	RAL 060 60 05	RAL 240 20 22	RAL 220 70 10	RAL 130 30 20	RAL 040 50 50	RAL 070 70 80
Suffix*	PF/B	PF/W	PF/SG	PF/DB	PF/LB	PF/GN	PF/CR	PF/Y
\$	160	160	160	160	160	160	160	160

LOUNGE CHAIRS

# Kruze

Chairs & Stools Collection

boss





Possessing presence and panache, the highly versatile Kruze chair and stool will complement a range of environments and draws the eye to its elegant form.





## Range Information

- The gently sculpted contours and generous proportions, promise outstanding sitting comfort.
- Available in 4-leg, skid frame, 4 star base, 5 star with castors, 4-leg oak or walnut frame, 4-leg stool, or stool with trumpet base
- CMHR moulded seat and back foam
- Available fully upholstered in fabric or leather
- Glides for hard or soft floors
- American Black Walnut or Oak show-wood outer also available
- Available on a cruciform wooden base, in Oak and Walnut, or painted wire frame in any RAL color
- Kruze table collection is also available
- Not recommended to be upholstered in Grade 1 fabrics



KRU/1 FOUR LEG	Code:	Description	COM /1	2	3	4	5	6	7	8	9	10	COL	L1	L2	L3	(ly)	(ft <sup>2</sup> )	(lb)
	<b>KRU/1/O</b>	Kruze 4-leg oak outershell	1964	2002	2048	2078	2132	2170	2238	2314	2412	2502	2024	2444	2700	3482	1.50	27	
	<b>KRU/1/W</b>	Kruze 4-leg walnut outershell	1928	1966	2012	2042	2096	2134	2202	2278	2376	2466	1986	2406	2662	3444	1.50	27	

**DIMENSIONS**  
 Height: **850mm (33.5")**  
 Width: **605mm (24")**  
 Depth: **635mm (25")**  
 Seat Height: **455mm (17.75")**  
 Seat Depth: **460mm (18")**  
 Arm Height: **610mm (24")**

**Painted Frame Options**

Color Choice	RAL 9005	RAL 9016	RAL 060 60 05	RAL 240 20 22	RAL 220 70 10	RAL 130 30 20	RAL 040 50 50	RAL 070 70 80
Suffix*	PF/B	PF/W	PF/SG	PF/DB	PF/LB	PF/GN	PF/CR	PF/Y
\$	100	100	100	100	100	100	100	100

KRU/2 SLED BASE	Code:	Description	COM /1	2	3	4	5	6	7	8	9	10	COL	L1	L2	L3	(ly)	(ft <sup>2</sup> )	(lb)
	<b>KRU/2/O</b>	Kruze sled base oak outershell	2018	2056	2102	2132	2186	2224	2292	2368	2466	2556	2078	2498	2754	3536	1.50	27	
	<b>KRU/2/W</b>	Kruze sled base walnut outershell	1984	2022	2068	2098	2152	2190	2258	2334	2432	2522	2044	2464	2720	3502	1.50	27	

**DIMENSIONS**  
 Height: **850mm (33.5")**  
 Width: **605mm (24")**  
 Depth: **630m (24.75")**  
 Seat Height: **450mm (17.75")**  
 Seat Depth: **460mm (18")**  
 Arm Height: **610mm (24")**

**Painted Frame Options**

Color Choice	RAL 9005	RAL 9016	RAL 060 60 05	RAL 240 20 22	RAL 220 70 10	RAL 130 30 20	RAL 040 50 50	RAL 070 70 80
Suffix*	PF/B	PF/W	PF/SG	PF/DB	PF/LB	PF/GN	PF/CR	PF/Y
\$	100	100	100	100	100	100	100	100

CHAIRS & STOOLS

**KRU/3**  
4-LEG OAK/WALNUT FRAME

Code:	Description	COM /1	2	3	4	5	6	7	8	9	10	COL	L1	L2	L3	(ly)	(ft²)	(lb)
<b>KRU/3/O/FU</b>	Kruze 4-leg oak base fully upholstered	2040	2098	2166	2212	2292	2350	2452	2566	2714	2850	2120	2756	3146	4334	2.25	41	
<b>KRU/3/O</b>	Kruze 4-leg oak base oak shell	2426	2464	2510	2540	2594	2632	2700	2776	2874	2964	2490	2910	3166	3948	1.50	27	
<b>KRU/3/W/FU</b>	Kruze 4-leg walnut base fully upholstered	2268	2326	2394	2440	2520	2578	2680	2794	2942	3078	2350	2986	3376	4564	2.25	41	
<b>KRU/3/W</b>	Kruze 4-leg walnut base walnut shell	2620	2658	2704	2734	2788	2826	2894	2970	3068	3158	2686	3106	3362	4144	1.50	27	

**DIMENSIONS**

Height: **850mm (33.5")**  
 Width: **605mm (24")**  
 Depth: **645mm (25.25")**  
 Seat Height: **455mm (18")**  
 Seat Depth: **460mm (18")**  
 Arm Height: **610mm (24")**

**KRU/4**  
4 STAR BASE

Code:	Description	COM /1	2	3	4	5	6	7	8	9	10	COL	L1	L2	L3	(ly)	(ft²)	(lb)
<b>KRU/4/FU</b>	Kruze 4-star fully upholstered	1800	1858	1926	1972	2052	2110	2212	2326	2474	2610	1878	2514	2904	4092	2.25	41	
<b>KRU/4/O</b>	Kruze 4-star oak outershell	2186	2224	2270	2300	2354	2392	2460	2536	2634	2724	2248	2668	2924	3706	1.50	27	
<b>KRU/4/W</b>	Kruze 4-star walnut outershell	2150	2188	2234	2264	2318	2356	2424	2500	2598	2688	2210	2630	2886	3668	1.50	27	
<b>KRU/4/FU/CASTORS</b>	Kruze 4-star fully upholstered, on castors	1910	1968	2036	2082	2162	2220	2322	2436	2584	2720	1988	2624	3014	4202	2.25	41	
<b>KRU/4/O/CASTORS</b>	Kruze 4-star oak outershell, on castors	2246	2284	2330	2360	2414	2452	2520	2596	2694	2784	2308	2728	2984	3766	1.50	27	
<b>KRU/4/W/CASTORS</b>	Kruze 4-star walnut outershell on castors	2210	2248	2294	2324	2378	2416	2484	2560	2658	2748	2272	2692	2948	3730	1.50	27	

**DIMENSIONS**

Height: **850mm (33.5")**  
 Width: **605mm (24")**  
 Depth: **610mm (24")**  
 Seat Height: **450mm (17.75")**  
 Seat Depth: **460mm (18")**  
 Arm Height: **610mm (24")**

**Painted Frame Options**

Color Choice	RAL 9005	RAL 9016	RAL 060 60 05	RAL 240 20 22	RAL 220 70 10	RAL 130 30 20	RAL 040 50 50	RAL 070 70 80
Suffix*	PF/B	PF/W	PF/SG	PF/DB	PF/LB	PF/GN	PF/CR	PF/Y
\$	160	160	160	160	160	160	160	160

<b>KRU/5</b> 5 STAR BASE CASTORS	Code:	Description	COM /1	2	3	4	5	6	7	8	9	10	COL	L1	L2	L3	Icons	
																	(ly)	(ft²)
	<b>KRU/5/FU/ CASTORS</b>	Kruze 5 star base on castors fully upholstered	1846	1904	1972	2018	2098	2156	2258	2372	2520	2656	1924	2560	2950	4138	2.25	41
	<b>KRU/5/O/ CASTORS</b>	Kruze 5 star base on castors oak outershell	2184	2222	2268	2298	2352	2390	2458	2534	2632	2722	2246	2666	2922	3704	1.50	27
	<b>KRU/5/W/ CASTORS</b>	Kruze 5 star base on castors walnut outershell	2148	2186	2232	2262	2316	2354	2422	2498	2596	2686	2208	2628	2884	3666	1.50	27

**DIMENSIONS**  
 Height: **810-930mm (32-26.5")**  
 Width: **605mm (24")**  
 Depth: **610mm (24")**  
 Seat Height: **410-530mm (16-21")**  
 Seat Depth: **460mm (18")**



**KRU/6**  
4-LEG STOOL WITH BACK



**DIMENSIONS**

Height: **1060mm (41.75")**  
 Width: **510mm (20")**  
 Depth: **530mm (21")**  
 Seat Height: **770mm (30.25")**  
 Seat Depth: **410mm (16.25")**

Code:	Description	COM /1	2	3	4	5	6	7	8	9	10	COL	L1	L2	L3	(ly)	(ft²)	(lb)
<b>KRU/6/FU</b>	Kruze stool 4-leg with back, fully upholstered	1336	1374	1420	1450	1504	1542	1610	1686	1784	1874	1388	1808	2064	2846	1.50	27	
<b>KRU/6/O</b>	Kruze stool 4-leg with back & oak outershell	1614	1634	1658	1674	1702	1722	1756	1794	1844	1890	1652	1870	2002	2408	0.75	14	
<b>KRU/6/W</b>	Kruze stool 4-leg with back & walnut outershell	1570	1590	1614	1630	1658	1678	1712	1750	1800	1846	1606	1824	1956	2362	0.75	14	

**Painted Frame Options**

Color Choice	RAL 9005	RAL 9016	RAL 060 60 05	RAL 240 20 22	RAL 220 70 10	RAL 130 30 20	RAL 040 50 50	RAL 070 70 80
Suffix*	PF/B	PF/W	PF/SG	PF/DB	PF/LB	PF/GN	PF/CR	PF/Y
\$	100	100	100	100	100	100	100	100

**KRU/6/CH**  
4-LEG COUNTER HEIGHT STOOL WITH BACK

**DIMENSIONS**

Height: **950mm (37.5")**  
 Width: **510mm (20")**  
 Depth: **530mm (21")**  
 Seat Height: **660mm (26")**  
 Seat Depth: **410mm (16.25")**

Code:	Description	COM /1	2	3	4	5	6	7	8	9	10	COL	L1	L2	L3	(ly)	(ft²)	(lb)
<b>KRU/6/CH/FU</b>	Kruze counter height stool 4-leg with back, fully upholstered	1336	1374	1420	1450	1504	1542	1610	1686	1784	1874	1388	1808	2064	2846	1.50	27	
<b>KRU/6/CH/O</b>	Kruze counter height stool 4-leg with back & oak outershell	1614	1634	1658	1674	1702	1722	1756	1794	1844	1890	1652	1870	2002	2408	0.75	14	
<b>KRU/6/CH/W</b>	Kruze counter height stool 4-leg with back & walnut outershell	1570	1590	1614	1630	1658	1678	1712	1750	1800	1846	1606	1824	1956	2362	0.75	14	

**Painted Frame Options**

Color Choice	RAL 9005	RAL 9016	RAL 060 60 05	RAL 240 20 22	RAL 220 70 10	RAL 130 30 20	RAL 040 50 50	RAL 070 70 80
Suffix*	PF/B	PF/W	PF/SG	PF/DB	PF/LB	PF/GN	PF/CR	PF/Y
\$	100	100	100	100	100	100	100	100

**KRU/7  
4-LEG STOOL NO BACK**



**DIMENSIONS**

Height: **820mm (32.25")**  
 Width: **510mm (20")**  
 Depth: **540mm (21.25")**  
 Seat Height: **770mm (30.25")**  
 Seat Depth: **430mm (17")**

Code:	Description	COM /1	2	3	4	5	6	7	8	9	10	COL	L1	L2	L3	(ly)	(ft²)	(lb)
<b>KRU/7/FU</b>	Kruze stool 4-leg no back fully upholstered	930	962	1000	1026	1070	1102	1160	1224	1306	1382	972	1330	1548	2214	1.25	23	
<b>KRU/7/O</b>	Kruze stool 4-leg no back Oak outershell	1074	1094	1118	1134	1162	1182	1216	1254	1304	1350	1106	1324	1456	1862	0.75	14	
<b>KRU/7/W</b>	Kruze stool 4-leg no back Walnut outershell	1056	1076	1100	1116	1144	1164	1198	1236	1286	1332	1088	1306	1438	1844	0.75	14	

**Painted Frame Options**

Color Choice	RAL 9005	RAL 9016	RAL 060 60 05	RAL 240 20 22	RAL 220 70 10	RAL 130 30 20	RAL 040 50 50	RAL 070 70 80
Suffix*	PF/B	PF/W	PF/SG	PF/DB	PF/LB	PF/GN	PF/CR	PF/Y
\$	100	100	100	100	100	100	100	100

**KRU/7/CH  
4-LEG COUNTER HEIGHT  
STOOL NO BACK**

**DIMENSIONS**

Height: **950mm (37.5")**  
 Width: **510mm (20")**  
 Depth: **540mm (21.25")**  
 Seat Height: **660mm (26")**  
 Seat Depth: **430mm (17")**

Code:	Description	COM /1	2	3	4	5	6	7	8	9	10	COL	L1	L2	L3	(ly)	(ft²)	(lb)
<b>KRU/7/CH/FU</b>	Kruze counter height stool 4-leg no back fully upholstered	930	962	1000	1026	1070	1102	1160	1224	1306	1382	972	1330	1548	2214	1.25	23	
<b>KRU/7/CH/O</b>	Kruze counter height stool 4-leg no back Oak outershell	1074	1094	1118	1134	1162	1182	1216	1254	1304	1350	1106	1324	1456	1862	0.75	14	
<b>KRU/7/CH/W</b>	Kruze counter height stool 4-leg no back Walnut outershell	1056	1076	1100	1116	1144	1164	1198	1236	1286	1332	1088	1306	1438	1844	0.75	14	

**Painted Frame Options**

Color Choice	RAL 9005	RAL 9016	RAL 060 60 05	RAL 240 20 22	RAL 220 70 10	RAL 130 30 20	RAL 040 50 50	RAL 070 70 80
Suffix*	PF/B	PF/W	PF/SG	PF/DB	PF/LB	PF/GN	PF/CR	PF/Y
\$	100	100	100	100	100	100	100	100

**KRU/8  
STOOL SQUARE BASE  
WITH BACK**



**DIMENSIONS**

Height: **945mm-1185mm  
(37.25"-46.75")**  
 Width: **440mm (17.25")**  
 Depth: **440mm (17.25")**  
 Seat Height: **615-855mm  
(24.25"-33.75")**  
 Seat Depth: **440mm (17.25")**

Code:	Description	COM /1	2	3	4	5	6	7	8	9	10	COL	L1	L2	L3	(ly)	(ft²)	(lb)
<b>KRU/8/FU</b>	Kruze stool sq base with back fully upholstered	1190	1228	1274	1304	1358	1396	1464	1540	1638	1728	1242	1662	1918	2700	1.50	27	
<b>KRU/8/O</b>	Kruze stool square base with back oak outershell	1426	1446	1470	1486	1514	1534	1568	1606	1656	1702	1462	1680	1812	2218	0.75	14	
<b>KRU/8/W</b>	Kruze stool square base with back walnut outershell	1334	1354	1378	1394	1422	1442	1476	1514	1564	1610	1368	1586	1718	2124	0.75	14	

**KRU/9  
STOOL SQUARE BASE  
NO BACK**



**DIMENSIONS**

Height: **615-855mm  
(24.25"-33.75")**  
 Width: **440mm (17.25")**  
 Depth: **440mm (17.25")**  
 Seat Height: **615-855mm  
(24.25"-33.75")**  
 Seat Depth: **440mm (17.25")**

Code:	Description	COM /1	2	3	4	5	6	7	8	9	10	COL	L1	L2	L3	(ly)	(ft²)	(lb)
<b>KRU/9/FU</b>	Kruze stool sq base no back fully upholstered	1566	1598	1636	1662	1706	1738	1796	1860	1942	2018	1614	1972	2190	2856	1.25	23	
<b>KRU/9/O</b>	Kruze stool sq base no back oak outershell	1944	1964	1988	2004	2032	2052	2086	2124	2174	2220	1984	2202	2334	2740	0.75	14	
<b>KRU/9/W</b>	Kruze stool sq base no back walnut outershell	1874	1894	1918	1934	1962	1982	2016	2054	2104	2150	1914	2132	2264	2670	0.75	14	

<b>KRU/10</b> <b>TRUMPET BASE WITH BACK</b>	<b>Code:</b>	<b>Description</b>	<b>COM</b>	<b>2</b>	<b>3</b>	<b>4</b>	<b>5</b>	<b>6</b>	<b>7</b>	<b>8</b>	<b>9</b>	<b>10</b>	<b>COL</b>	<b>L1</b>	<b>L2</b>	<b>L3</b>			
	<b>KRU/10/FU</b>	Kruze stool trumpet base with back fully upholstered	1564	1602	1648	1678	1732	1770	1838	1914	2012	2102	1620	2040	2296	3078	1.50	27	
	<b>KRU/10/O</b>	Kruze stool trumpet base with back oak outershell	1800	1820	1844	1860	1888	1908	1942	1980	2030	2076	1840	2058	2190	2596	0.75	14	
	<b>KRU/10/W</b>	Kruze stool trumpet base with back walnut outershell	1840	1860	1884	1900	1928	1948	1982	2020	2070	2116	1880	2098	2230	2636	0.75	14	

**DIMENSIONS**  
 Height: **945mm-1185mm (37.25"-46.75")**  
 Width: **530mm (20.75")**  
 Depth: **530mm (20.75")**  
 Seat Height: **590-840mm (23.25"-33")**  
 Seat Depth: **440mm (17.25")**

<b>KRU/11</b> <b>TRUMPET BASE WITH NO BACK</b>	<b>Code:</b>	<b>Description</b>	<b>COM</b>	<b>2</b>	<b>3</b>	<b>4</b>	<b>5</b>	<b>6</b>	<b>7</b>	<b>8</b>	<b>9</b>	<b>10</b>	<b>COL</b>	<b>L1</b>	<b>L2</b>	<b>L3</b>			
	<b>KRU/11/FU</b>	Kruze stool trumpet base no back fully upholstered	1158	1190	1228	1254	1298	1330	1388	1452	1534	1610	1202	1560	1778	2444	1.25	23	
	<b>KRU/11/O</b>	Kruze stool trumpet base no back oak outershell	1284	1304	1328	1344	1372	1392	1426	1464	1514	1560	1318	1536	1668	2074	0.75	14	
	<b>KRU/11/W</b>	Kruze stool trumpet base no back walnut outershell	1300	1320	1344	1360	1388	1408	1442	1480	1530	1576	1334	1552	1684	2090	0.75	14	

**DIMENSIONS**  
 Height: **590-840mm (23.25"-33")**  
 Width: **530mm (20.75")**  
 Depth: **530mm (20.75")**  
 Seat Height: **590-840mm (23.25"-33")**  
 Seat Depth: **440mm (17.25")**



# Kruze Lounge

Lounge Chair

boss



A fusion of classic and contemporary defines the philosophy behind the Kruze Lounge chair. A striking visual and sitting experience, intelligent design combines with the finest craftsmanship.

The high sculpted back and gently curving contours promise outstanding sitting comfort, while its distinctive profile makes it a stand-alone statement piece to enhance any executive lounge, reception or meeting area.



LOUNGE CHAIRS





A fusion of classic and contemporary defines the philosophy behind the Kruze Lounge chair. A striking visual and sitting experience, Kruze Lounge combines beautiful design with the finest craftsmanship.

# Kruze Lounge

Lounge Chair

boss



## Range Information

- The high sculpted back and gently curving contours promise outstanding sitting comfort, while its distinctive profile makes it a stand-alone statement piece to enhance any executive lounge, reception or meeting area.
- Supported by a polished aluminum four star base (also available painted)
- CMHR moulded seat and back foam
- Fully upholstered in fabric or leather
- Glides for hard or soft floors
- American Black Walnut or Oak show-wood outer also available
- Painted bases in 8 standard Boss colors
- To specify a matching table, please see the Axis Table range
- Not recommended to be upholstered in Graded 1 fabrics



KRUL/4 FOUR STAR HIGH BACK	Code:	Description	COM /1	2	3	4	5	6	7	8	9	10	COL	L1	L2	L3	(ly)	(ft <sup>2</sup> )	(lb)
 <p><b>DIMENSIONS</b>            Height: <b>1100 (43.25")</b>            Width: <b>750mm (29.75")</b>            Depth: <b>770mm (30.5")</b>            Seat Height: <b>440mm (17.25")</b>            Arm Height: <b>600mm (23.75")</b></p>	KRUL/4/ HB/FU	Kruze Lounge high back fully upholstered	3518	3606	3712	3782	3906	3994	4152	4328	4556	4766	3644	4622	5220	7046	3.50	63	
	KRUL/4/ HB/O	Kruze Lounge high back oak outershell	4418	4476	4544	4590	4670	4728	4830	4944	5092	5228	4522	5158	5548	6736	2.25	41	
	KRUL/4/ HB/W	Kruze Lounge high back walnut outershell	4548	4606	4674	4720	4800	4858	4960	5074	5222	5358	4654	5290	5680	6868	2.25	41	

KRUL/4 FOUR STAR LOW BACK	Code:	Description	COM /1	2	3	4	5	6	7	8	9	10	COL	L1	L2	L3	(ly)	(ft <sup>2</sup> )	(lb)
 <p><b>DIMENSIONS</b>            Height: <b>830mm (32.75")</b>            Width: <b>750mm (29.75")</b>            Depth: <b>750mm (29.75")</b>            Seat Height: <b>440mm (17.25")</b>            Arm Height: <b>600mm (23.75")</b></p>	KRUL/4/ LB/FU	Kruze Lounge low back fully upholstered	3080	3162	3260	3326	3440	3522	3670	3834	4046	4242	3194	4110	4670	6380	3.25	59	
	KRUL/4/ LB/O	Kruze Lounge low back oak outershell	3854	3904	3964	4004	4074	4124	4214	4314	4444	4564	3944	4502	4844	5888	2.00	36	
	KRUL/4/ LB/W	Kruze Lounge low back walnut outershell	4220	4270	4330	4370	4440	4490	4580	4680	4810	4930	4314	4872	5214	6258	2.00	36	

LOUNGE CHAIRS

N.B. Leather is a natural material which will crease and 'puddle'.

 Fabric Linear Yard  Leather Square Footage  Product Weight

### Painted Frame Options

Color Choice	RAL 9005	RAL 9016	RAL 060 60 05	RAL 240 20 22	RAL 220 70 10	RAL 130 30 20	RAL 040 50 50	RAL 070 70 80
Suffix*	PF/B	PF/W	PF/SG	PF/DB	PF/LB	PF/GN	PF/CR	PF/Y
\$	160	160	160	160	160	160	160	160

# Kruze Lounge Plush

boss

Lounge Seating



## Range Information

- A new addition to the Kruze Lounge family, the Kruze Lounge Plush redefines comfort whilst maintaining the striking aesthetic that Kruze is known for
- Four star base available in polished aluminum as standard, or a painted finish with an additional upcharge
- The four star base is supplied with glides to suit both hard and soft floor surfaces
- Available fully upholstered in either fabric or leather
- Currently, Kruze Lounge Plush is only available in the following fabric and leathers:
  - **Fabric**
    - Camira Yoredale
    - Camira Craggan Flax
    - Maharam Merit
    - Kvadrat Coda
  - **Leather (L2)**
    - Lena
- For customers own fabric/leather, please contact us so we can advise on suitability



**KRUL/4/HB/PLUSH**  
**KRUZE LOUNGE HIGH BACK**  
**PLUSH**

**Code:**      **Description**      **COM**    2    3    4    5    6    7    8    9    10    COL    L1    L2    L3

(ly)    (ft²)    (lb)



**KRUL/4/  
 HB/  
 PLUSH**

Kruze Lounge  
 high back plush  
 upholstery

3050    -    -    -    3482    3580    3756    3952    4206    4440    3180    4266    6016    -    3.90    70

**DIMENSIONS**

Height: **1100 (43.25")**  
 Width: **750mm (29.75")**  
 Depth: **770mm (30.5")**  
 Seat Height: **440mm (17.25")**  
 Arm Height: **600mm (23.75")**

N.B. Leather is a natural material which will crease and 'puddle'.

Fabric Linear Yard    Leather Square Footage    Product Weight

LOUNGE SEATING

**Painted Frame Options**

Color Choice	RAL 9005	RAL 9016	RAL 060 60 05	RAL 240 20 22	RAL 220 70 10	RAL 130 30 20	RAL 040 50 50	RAL 070 70 80
Suffix*	PF/B	PF/W	PF/SG	PF/DB	PF/LB	PF/GN	PF/CR	PF/Y
\$	160	160	160	160	160	160	160	160





## Range Information

- Solid hardwood timber frame
- CMHR foam and fibre seat
- Foam back cushion
- Webbed seat and back support
- Linear stitch detail on seat and back
- Removable lumbar cushion
- Side & Coffee Tables also available with white table top upon request
- Timber frame available in Oak, American Black Walnut or to a painted finish (painted finish is \$236)
- Not recommended to be upholstered in Graded 1 fabrics



**LUGE  
ARMCHAIR**

Code:	Description	COM /1	2	3	4	5	6	7	8	9	10	COL	L1	L2	L3	(ly)	(ft²)	(lb)
	<b>LUG/1</b> Luge Armchair, Oak	2338	2426	2532	2602	2726	2814	2972	3148	3376	3586	2452	3430	4028	5854	3.50	63	
	<b>LUG/3</b> Luge Armchair, American Black Walnut	2490	2578	2684	2754	2878	2966	3124	3300	3528	3738	2604	3582	4180	6006	3.50	63	

**DIMENSIONS**

Height: **690mm (27.25")**  
 Width: **690mm (27.25")**  
 Depth: **835mm (32.75")**  
 Seat Height: **390mm (15.25")**

**LUGE  
TWO SEAT SOFA**

Code:	Description	COM /1	2	3	4	5	6	7	8	9	10	COL	L1	L2	L3	(ly)	(ft²)	(lb)
	<b>LUG/2</b> Luge Two Seat Sofa, Oak	3376	3490	3626	3716	3874	3988	4192	4418	4712	4982	3526	4782	5552	7900	4.50	81	
	<b>LUG/4</b> Luge Two Seat Sofa, American Black Walnut	3506	3620	3756	3846	4004	4118	4322	4548	4842	5112	3658	4914	5684	8032	4.50	81	

**DIMENSIONS**

Height: **690mm (27.25")**  
 Width: **1340mm (52.75")**  
 Depth: **835mm (32.75")**  
 Seat Height: **390mm (15.25")**

LOUNGE SEATING

N.B. Leather is a natural material which will crease and 'puddle'.

 Fabric Linear Yard  Leather Square Footage  Product Weight

**LUGE  
SIDE TABLE**



**DIMENSIONS**

Height: 465mm (18.25")  
 Width: 450mm (17.75")  
 Depth: 400mm (15.75")

**Code:**

**Description**

**\$**

  
(lb)

**LUG/5**

Luge Side Table, Oak underframe with veneered top

1694

**LUG/6**

Luge Side Table, American Walnut underframe with veneered top

1788

**LUGE  
SMALL COFFEE TABLE**



**Code:**

**Description**

**\$**

  
(lb)

**LUG/7**

Luge Small Coffee Table, Oak underframe with veneered top

2310



**LUG/8**

Luge Small Coffee Table, American Black Walnut underframe with veneered top

2420

**DIMENSIONS**

Height: 350mm (13.75")  
 Width: 750mm (29.5")  
 Depth: 500mm (19.75")

 Fabric Linear Yard  Product Weight

**LUGE**  
LARGE COFFEE TABLE

**Code:**

**Description**

**\$**

  
(lb)



**LUG/9**

Luge Large Coffee Table, Oak underframe with veneered top

2630



**LUG/10**

Luge Large Coffee Table, American Black Walnut underframe with veneered top

2784

**DIMENSIONS**

Height: **350mm (13.75")**  
Width: **1150mm (45.25")**  
Depth: **500mm (19.75")**

 Fabric Linear Yard  Product Weight



LOUNGE SEATING











## Range Information

Magic is a compact, elegant stool that showcases great design, comfort and is exceptionally practical. It is ideally suited to informal reception, atrium or meeting and breakout spaces. Available in a selection of fabrics, leathers and finishes, Magic is suited to purist office environments where it adds splashes of vibrant color that bring an environment to life.

Magic may be specified as a stool, island unit or coffee table and comes on a chromed base.

- Dual density CMHR polyurethane foam seat
- Chrome base
- Painted Frames options
- Not recommended to be upholstered in Graded 1 fabrics



<b>MAG/1 STOOL</b>	<b>Code:</b>	<b>Description</b>	<b>COM</b> <b>/1</b>	<b>2</b>	<b>3</b>	<b>4</b>	<b>5</b>	<b>6</b>	<b>7</b>	<b>8</b>	<b>9</b>	<b>10</b>	<b>COL</b>	<b>L1</b>	<b>L2</b>	<b>L3</b>			
  <b>DIMENSIONS</b> Height: <b>460mm (18")</b> Diameter: <b>575mm (22.75")</b>	<b>MAG/1C</b>	Stool, chrome base	1482	1514	1552	1578	1622	1654	1712	1776	1858	1934	1530	1888	2106	2772	1.25	23	
	<b>MAG/1/ PF</b>	Stool, painted base <small>*Suffix your PF code with the color code listed below</small>	+200	+200	+200	+200	+200	+200	+200	+200	+200	+200	+200	+200	+200	+200	1.25	23	
<b>MAG/2 STOOL</b>	<b>Code:</b>	<b>Description</b>	<b>COM</b> <b>/1</b>	<b>2</b>	<b>3</b>	<b>4</b>	<b>5</b>	<b>6</b>	<b>7</b>	<b>8</b>	<b>9</b>	<b>10</b>	<b>COL</b>	<b>L1</b>	<b>L2</b>	<b>L3</b>			
  <b>DIMENSIONS</b> Height: <b>480mm (19")</b> Diameter: <b>1000mm (39.5")</b>	<b>MAG/2C</b>	Island stool chrome base	2976	3034	3102	3148	3228	3286	3388	3502	3650	3786	3066	3702	4092	5280	2.25	41	
	<b>MAG/2/ PF*</b>	Island stool painted base <small>*Suffix your PF code with the color code listed below</small>	+300	+300	+300	+300	+300	+300	+300	+300	+300	+300	+300	+300	+300	+300	2.25	41	

N.B. Leather is a natural material which will crease and 'puddle'.

 Fabric Linear Yards  Sq Ft of leather  Product Weight

<b>800MM DIAMETER TOP</b>	<b>Code:</b>	<b>Description:</b>	<b>Unit Size</b> Dia x H		<b>Square Edge Only Laminate</b> 1"	<b>Chamfered Edge Only Laminate</b> 1"	 (lb)
  <b>DIMENSIONS</b> Height: <b>345mm (13.5")</b> Diameter: <b>800mm (31.5")</b>	<b>MAG/3C</b>	Coffee Table 31.5" (800mm) Dia Top Chrome Frame	Dia 800mm 31.5"	345mm 16.25"	1462	1616	
	<b>MAG/3C/PF*</b>	Coffee Table 31.5" (800mm) Dia Top Painted Frame <small>*Suffix your PF code with the color code listed below</small>	Dia 800mm 31.5"	345mm 16.25"	2288	2442	
<b>1200MM DIAMETER TOP</b>							
  <b>DIMENSIONS</b> Height: <b>345mm (13.5")</b> Diameter: <b>1200mm (47.25")</b>	<b>MAG/1200</b>	Coffee Table 47.25" (1200mm) Dia Top Chrome Frame	Dia 1200mm 47.25"	345mm 16.25"	2630	2906	
	<b>MAG/1200/PF*</b>	Coffee Table 47.25" (1200mm) Dia Top Painted Frame <small>*Suffix your PF code with the color code listed below</small>	Dia 1200mm 47.25"	345mm 16.25"	4118	4394	

STOOLS & TABLES

**\*Painted Frame Options**

<b>Color Choice</b>	<b>RAL 9005</b>	RAL 9016	RAL 060 60 05	<b>RAL 240 20 22</b>	RAL 220 70 10	RAL 130 30 20	RAL 040 50 50	<b>RAL 070 70 80</b>
<b>Suffix*</b>	PF/B	PF/W	PF/SG	PF/DB	PF/LB	PF/GN	PF/CR	PF/Y

# Marnie

Lounge Seating

boss



An exciting fusion of elegant design, premium upholstery and attention to detail, Marnie is a lounge chair collection which embodies luxury and style.





LOUNGE SEATING



## Range Information

- Fully upholstered in any fabric or leather with two-tone upholstery available
- CMHR moulded seat and back foam
- Choice of 360 degree swivel base, painted steel four-leg base, skid base, Oak or Walnut frame.
- Painted sled and 4 leg frame finishes available in Black and White as standard. Other colors available
- High and low back options available
- Stained and painted frames available
- Not recommended to be upholstered in Graded 1 fabrics





MRN/1 4 LEG POWDER COATED FRAME	Code:	Description	COM	2	3	4	5	6	7	8	9	10	COL	L1	L2	L3	(ly)	(ft²)	(lb)
			/1																
 	MRN/1/ HB	Marnie 4-leg powder coat high back	3010	3080	3164	3220	3318	3388	3512	3650	3830	3996	3112	3888	4362	5812	2.75	50	
	MRN/1/ MB	Marnie 4-leg powder coat mid back	2598	2656	2724	2770	2850	2908	3010	3124	3272	3408	2684	3320	3710	4898	2.25	41	

**DIMENSIONS**  
 HB Height: 1070mm (42.25")  
 MB Height: 825mm (32.5")  
 Width: 710mm (28")  
 Depth: 780mm (30.75")  
 Seat Height: 430mm (17")

**Painted Frame Options**

Color Choice	RAL 9005	RAL 9016	RAL 060 60 05	RAL 240 20 22	RAL 220 70 10	RAL 130 30 20	RAL 040 50 50	RAL 070 70 80
Suffix*	PF/B	PF/W	PF/SG	PF/DB	PF/LB	PF/GN	PF/CR	PF/Y
\$	inc	inc	100	100	100	100	100	100

MRN/2 SLED BASE	Code:	Description	COM	2	3	4	5	6	7	8	9	10	COL	L1	L2	L3	(ly)	(ft²)	(lb)
			/1																
 	MRN/2/ HB	Marnie sled painted high back	2432	2502	2586	2642	2740	2810	2934	3072	3252	3418	2528	3304	3778	5228	2.75	50	
	MRN/2/ MB	Marnie sled painted mid back	2074	2132	2200	2246	2326	2384	2486	2600	2748	2884	2154	2790	3180	4368	2.25	41	

**DIMENSIONS**  
 HB Height: 1065mm (42")  
 MB Height: 825mm (32.5")  
 Width: 710mm (28")  
 Depth: 780mm (30.75")  
 Seat Height: 430mm (17")

N.B. Leather is a natural material which will crease and 'puddle'.

 Fabric Linear Yard  Leather Square Footage  Product Weight

**Painted Frame Options**

Color Choice	RAL 9005	RAL 9016	RAL 060 60 05	RAL 240 20 22	RAL 220 70 10	RAL 130 30 20	RAL 040 50 50	RAL 070 70 80
Suffix*	PF/B	PF/W	PF/SG	PF/DB	PF/LB	PF/GN	PF/CR	PF/Y
\$	inc	inc	100	100	100	100	100	100

**MRN/3**  
4 LEG OAK FRAME

Code:	Description	COM /1	2	3	4	5	6	7	8	9	10	COL	L1	L2	L3	(ly)	(ft²)	(lb)
<b>MRN/3/ HB/O</b>	Marnie 4-leg oak high back	2686	2756	2840	2896	2994	3064	3188	3326	3506	3672	2784	3560	4034	5484	2.75	50	
<b>MRN/3/ HB/W</b>	Marnie 4-leg walnut high back	3348	3418	3502	3558	3656	3726	3850	3988	4168	4334	3454	4230	4704	6154	2.75	50	
<b>MRN/3/ MB/O</b>	Marnie 4-leg oak mid back	2532	2590	2658	2704	2784	2842	2944	3058	3206	3342	2616	3252	3642	4830	2.25	41	
<b>MRN/3/ MB/W</b>	Marnie 4-leg walnut mid back	2844	2902	2970	3016	3096	3154	3256	3370	3518	3654	2932	3568	3958	5146	2.25	41	



**DIMENSIONS**

HB Height: 1070mm (42.25")  
 MB Height: 825mm (32.5")  
 Width: 710mm (28")  
 Depth: 780mm (30.75")  
 Seat Height: 430mm (17")

**MRN/4**  
4 STAR POLISHED BASE

Code:	Description	COM /1	2	3	4	5	6	7	8	9	10	COL	L1	L2	L3	(ly)	(ft²)	(lb)
<b>MRN/4/ HB</b>	Marnie 4-star high back	2662	2732	2816	2872	2970	3040	3164	3302	3482	3648	2760	3536	4010	5460	2.75	50	
<b>MRN/4/ MB</b>	Marnie 4-star mid back	2292	2350	2418	2464	2544	2602	2704	2818	2966	3102	2374	3010	3400	4588	2.25	41	



**DIMENSIONS**

HB Height: 1070mm (42.25")  
 MB Height: 825mm (32.5")  
 Width: 710mm (28")  
 Depth: 780mm (30.75")  
 Seat Height: 430mm (17")

N.B. Leather is a natural material which will crease and 'puddle'.

Fabric Linear Yard Leather Square Footage Product Weight

**Painted Frame Options**

Color Choice	RAL 9005	RAL 9016	RAL 060 60 05	RAL 240 20 22	RAL 220 70 10	RAL 130 30 20	RAL 040 50 50	RAL 070 70 80
Suffix*	PF/B	PF/W	PF/SG	PF/DB	PF/LB	PF/GN	PF/CR	PF/Y
\$	160	160	160	160	160	160	160	160



LOUNGE SEATING

# Mars

Conference & Meeting Chairs

boss



## Range Information





Mars is a family of light and versatile chairs. The refined construction is strong and exceptionally comfortable. The generously proportioned and flexible polypropylene seat, back and arms combine to offer a modern aesthetic. Mars may be specified with a choice of back, which includes injection moulded perforated plastic, semi-upholstered or fully upholstered.

- Flexible polypropylene back
- Chrome legs and frame or polished aluminum
- Black, white or grey colored plastics options
- Writing tablet option on non-arm version only, positioned right hand as standard
- Stackable 4 chairs high (without trolley)
- Stacking Trolley available - 10 chairs high (1595mm or 63")
- Painted frames available
- Frame available as a cantilever, 4 leg, 4 leg on castors or as a 4 star base



CONFERENCE CHAIRS

**MAR/  
TASK CHAIR**

	Code:	Description	COM /1	2	3	4	5	6	7	8	9	10	COL	L1	L2	L3	(ly)	(ft²)	(lb)
 MAR/1	MAR/1	Plastic back Non-arm 4 leg Silver frame	596	616	640	656	684	704	738	776	826	872	624	842	974	1380	0.75	14	
 MAR/2	MAR/2	Semi-upholstered back Non-arm 4 leg Silver frame	634	654	678	694	722	742	776	814	864	910	662	880	1012	1418	0.75	14	
 MAR/3/C	MAR/3/C	Fully upholstered back Non-arm 4 leg Chrome Standard frame	830	862	900	926	970	1002	1060	1124	1206	1282	872	1230	1448	2114	1.25	23	
 MAR/7/A	MAR/7	Plastic 4 leg Non-arm silver frame (Black or white plastic)	444	-	-	-	-	-	-	-	-	-	-	-	-	-			

 Fabric Linear Yard  Leather Square Footage  Product Weight

**DIMENSIONS**

Height: **800mm (31.5")**  
 Width: **515mm (20.25")**  
 Depth: **550mm (21.75")**  
 Seat Height: **450mm (17.75")**  
 Seat Depth: **450mm (21.75")**  
 Arm Height: **675mm (26.5")**



**Back Colors**



Black back



Grey back



White back



Plastic back





Semi upholstered back



Fully upholstered back

**Back Finishes**

MAR/ TASK CHAIR	Code:	Description	COM /1	2	3	4	5	6	7	8	9	10	COL	L1	L2	L3	(ly)	(ft²)	(lb)
	MAR/4	Plastic back cantilever Non-arm silver frame	646	666	690	706	734	754	788	826	876	922	674	892	1024	1430	0.75	14	
	MAR/5	Semi-upholstered back cantilever non arm with silver frame	684	704	728	744	772	792	826	864	914	960	712	930	1062	1468	0.75	14	
	MAR/6/C	Fully upholstered back cantilever Non-arm Chrome frame	920	952	990	1016	1060	1092	1150	1214	1296	1372	962	1320	1538	2204	1.25	23	

CONFERENCE CHAIRS

**DIMENSIONS**

Height: **810mm (32")**  
 Width: **510mm (20")**  
 Depth: **550mm (21.75")**  
 Seat Height: **450mm (17.75")**  
 Seat Depth: **450mm (17.75")**  
 Arm Height: **680mm (26.75")**

**Options**

CODE:	DESCRIPTION	\$
P4	4 star polished swivel base (MAR/1, MAR/2, MAR/3)	458
P5	5 star polished swivel base on castors (MAR/1, MAR/2, MAR/3)	320
4C	"Castors option on 4 leg frame (Plastic & Semi-Upholstered)"	72
C	Chrome frame	72
A	Arms	72
LM	Linking mechanism (excludes MAR/7)	42
WT	Writing tablet (Non-arm version only)	184
ST	Stacking trolley (MAR/1, MAR/2, MAR/3)	??

**Painted Frame Options**

Color Choice	RAL 9005	RAL 9016	RAL 060 60 05	RAL 240 20 22	RAL 220 70 10	RAL 130 30 20	RAL 040 50 50	RAL 070 70 80
Suffix*	PF/B	PF/W	PF/SG	PF/DB	PF/LB	PF/GN	PF/CR	PF/Y
4 Leg	100	100	100	100	100	100	100	100
Canti	100	100	100	100	100	100	100	100



# Mr & Mrs

Lounge Seating

boss



## Range Information

- Range consists of high and Low-back wing chair
- Fixed seat cushion
- Top stitch detail
- Profiled foam seat with coil spring unit
- Cannot be upholstered in the following:
  - Vinyl
  - Certain Leathers\*
- \*Due to the design of Mr & Mrs we recommend prior leather and fabric approval to ensure the highest quality finish.
- Wooden button detailing on Mr chair only. Fabric button available upon request.
- Timber underframe/legs available in Oak, American Black Walnut or to a painted finish (painted finish is \$236)
- A full range of line drawings and images in the Mr & Mrs range can be downloaded from our website [bossdesign.com](http://bossdesign.com)
- Not recommended to be upholstered in Graded 1 fabrics



LOUNGE SEATING

## Lounge Seating

MR CHAIR, UNDERFRAME	Code:	Description	COM	2	3	4	5	6	7	8	9	10	COL	L1	L2	L3	(ly)	(ft²)	(lb)
			/1																
	MR/1/ OAK	Mr Chair, Underframe, Oak (As Shown)	4008	4184	4394	4534	4780	4956	5272	5622	6078	6498	4226	6118	7276	10814	7.00	122	
	MR/1/ ABW	Mr Chair, Underframe, American Black Walnut	4134	4310	4520	4660	4906	5082	5398	5748	6204	6624	4354	6246	7404	10942	7.00	122	

### DIMENSIONS

Height: 1120mm (44")  
 Width: 780mm (31")  
 Depth: 780mm (31")  
 Seat Height: 450mm (17.75")

MR CHAIR TURNED LEGS	Code:	Description	COM	2	3	4	5	6	7	8	9	10	COL	L1	L2	L3	(ly)	(ft²)	(lb)
			/1																
	MR/2/ OAK	Mr Chair Turned Legs Oak	3646	3822	4032	4172	4418	4594	4910	5260	5716	6136	3862	5754	6912	10450	7.00	122	
	MR/2/ ABW	Mr Chair Turned Legs American Black Walnut	3672	3848	4058	4198	4444	4620	4936	5286	5742	6162	3888	5780	6938	10476	7.00	122	

### DIMENSIONS

Height: 1120mm (44")  
 Width: 780mm (31")  
 Depth: 780mm (31")  
 Seat Height: 450mm (17.75")

 Fabric Linear Yard  Leather Square Footage  Product Weight

**MRS CHAIR UNDERFRAME**

Code:	Description	COM /1	2	3	4	5	6	7	8	9	10	COL	L1	L2	L3	(ly)	(ft²)	(lb)
<b>MRS/1/OAK</b>	Mrs Chair Underframe Oak	3924	4074	4254	4374	4584	4734	5004	5304	5694	6054	4116	5652	6592	9462	6.00	99	
<b>MRS/1/ABW</b>	Mrs Chair Walnut Underframe	4048	4198	4378	4498	4708	4858	5128	5428	5818	6178	4240	5776	6716	9586	6.00	99	



**DIMENSIONS**  
 Height: **960mm (38")**  
 Width: **730mm (29")**  
 Depth: **760mm (31")**

**MRS CHAIR TURNED LEGS**

Code:	Description	COM /1	2	3	4	5	6	7	8	9	10	COL	L1	L2	L3	(ly)	(ft²)	(lb)
<b>MRS/2/OAK</b>	Mrs Chair Turned Legs Oak (As Shown)	3568	3718	3898	4018	4228	4378	4648	4948	5338	5698	3756	5292	6232	9102	6.00	99	
<b>MRS/2/ABW</b>	Mrs Chair Turned Legs American Black Walnut	3646	3796	3976	4096	4306	4456	4726	5026	5416	5776	3834	5370	6310	9180	6.00	99	



**DIMENSIONS**  
 Height: **960mm (38")**  
 Width: **730mm (29")**  
 Depth: **760mm (31")**

**MRS SOFA TURNED LEGS**

Code:	Description	COM /1	2	3	4	5	6	7	8	9	10	COL	L1	L2	L3	(ly)	(ft²)	(lb)
<b>MRS/4/OAK</b>	Mrs Sofa, Turned Legs, Oak (As Shown)	5424	5650	5920	6100	6416	6642	7048	7498	8084	8624	5708	8158	9658	14240	9.00	158	
<b>MRS/4/ABW</b>	Mrs Sofa, Turned Legs, American Black Walnut	5454	5680	5950	6130	6446	6672	7078	7528	8114	8654	5738	8188	9688	14270	9.00	158	



**DIMENSIONS**  
 Height: **960mm (38")**  
 Width: **1380mm (54")**  
 Depth: **760mm (31")**

LOUNGE SEATING

Nevez

Bench

boss





BENCHES

Through its sophisticated architectural styling, the design of the Nevez bench is simple, elegant and proportionally considered. It is slim, refined, polished. The bench can be seen in environments such as art galleries or lobbies, adding an architectural statement to its surroundings.



## Range Information

- Available in Oak or ABW
  - Black Dowels with Oak Bench
  - Brass Dowels with American Black Walnut Bench
  - Powder coated black legs
  - CMHR foam and fibre seat pad option
  - 78" (2000mm), 67" (1700mm) and 55" (1400mm) options
  - Not recommended to be upholstered in Graded 1 fabrics
- **N.B.** Not suitable for outdoor use



**55" (1400MM)  
WIDTH OAK**



	Code:	Description	COM /1	2	3	4	5	6	7	8	9	10	COL	L1	L2	L3	(ly)	(ft <sup>2</sup> )	(lb)
	NEV/B/1400/T/OAK	Timber Bench No seat pads	4354	-	-	-	-	-	-	-	-	-	-	-	-	-	-	-	-
	NEV/B/1400 /1/OAK	Left OR Right upholstered seat pad	4854	4880	4910	4930	4966	4992	5038	5088	5154	5214	4930	5210	5380	5902	1.00	18	
	NEV/B/1400 /2/OAK	Two Upholstered Seat Pads	5352	5402	5462	5502	5572	5622	5712	5812	5942	6062	5458	6016	6358	7402	2.00	36	

**67" (1700MM)  
WIDTH OAK**



	Code:	Description	COM /1	2	3	4	5	6	7	8	9	10	COL	L1	L2	L3	(ly)	(ft <sup>2</sup> )	(lb)
	NEV/B/1700 /T/OAK	Timber Bench No seat pads	4678	-	-	-	-	-	-	-	-	-	-	-	-	-	-	-	-
	NEV/B/1700 /1/OAK	One Upholstered End pad (L or R)	5178	5204	5234	5254	5290	5316	5362	5412	5478	5538	5258	5538	5708	6230	1.00	18	
	NEV/B/1700 /2E/OAK	Two Upholstered End Pads	5676	5726	5786	5826	5896	5946	6036	6136	6266	6386	5784	6342	6684	7728	2.00	36	
	NEV/B/1700 /2M/OAK	Two Upholstered Mid Pads	5676	5726	5786	5826	5896	5946	6036	6136	6266	6386	5784	6342	6684	7728	2.00	36	
	NEV/B/1700 /3/OAK	Three upholstered seat pads	6176	6252	6342	6402	6508	6584	6720	6870	7066	7246	6316	7154	7666	9232	3.00	54	

BENCHES



**78" (2000MM)  
WIDTH OAK**



	Code:	Description	COM /1	2	3	4	5	6	7	8	9	10	COL	L1	L2	L3	(ly)	(ft <sup>2</sup> )	(lb)
	NEV/B/2000 /T/OAK	Timber Bench No seat pads	4880	-	-	-	-	-	-	-	-	-	-	-	-	-	-	-	-
	NEV/B/2000 /1/OAK	One Upholstered End pad (L or R)	5380	5406	5436	5456	5492	5518	5564	5614	5680	5740	5462	5742	5912	6434	1.00	18	
	NEV/B/2000 /2E/OAK	Two Upholstered End Pads	5878	5928	5988	6028	6098	6148	6238	6338	6468	6588	5988	6546	6888	7932	2.00	36	
	NEV/B/2000 /2M/OAK	Two Upholstered Mid Pads	5878	5928	5988	6028	6098	6148	6238	6338	6468	6588	5988	6546	6888	7932	2.00	36	
	NEV/B/2000 /3/OAK	Three upholstered seat pads	6378	6454	6544	6604	6710	6786	6922	7072	7268	7448	6520	7358	7870	9436	3.00	54	



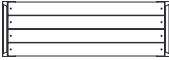

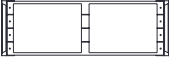
**55" (1400MM)  
WIDTH ABW**



Code:	Description	COM /1	2	3	4	5	6	7	8	9	10	COL	L1	L2	L3	(ly)	(ft <sup>2</sup> )	(lb)
 <b>NEV/B/1400/T/ABW</b>	Timber Bench No seat pads	4592	-	-	-	-	-	-	-	-	-	-	-	-	-	-	-	-
 <b>NEV/B/1400/1/ABW</b>	Left OR Right upholstered seat pad	5092	5118	5148	5168	5204	5230	5276	5326	5392	5452	5170	5450	5620	6142	1.00	18	
 <b>NEV/B/1400/2/ABW</b>	Two upholstered seat pads	5590	5640	5700	5740	5810	5860	5950	6050	6180	6300	5698	6256	6598	7642	2.00	36	

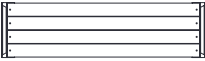

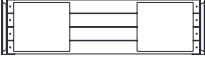
**67" (1700MM)  
WIDTH ABW**



Code:	Description	COM /1	2	3	4	5	6	7	8	9	10	COL	L1	L2	L3	(ly)	(ft <sup>2</sup> )	(lb)
 <b>NEV/B/1700/T/ABW</b>	Timber Bench No seat pads	4976	-	-	-	-	-	-	-	-	-	-	-	-	-	-	-	-
 <b>NEV/B/1700/1/ABW</b>	One Upholstered End pad (L or R)	5476	5502	5532	5552	5588	5614	5660	5710	5776	5836	5558	5838	6008	6530	1.00	18	
 <b>NEV/B/1700/2E/ABW</b>	Two Upholstered End Pads	5974	6024	6084	6124	6194	6244	6334	6434	6564	6684	6086	6644	6986	8030	2.00	36	
 <b>NEV/B/1700/2M/ABW</b>	Two Upholstered Mid Pads	5974	6024	6084	6124	6194	6244	6334	6434	6564	6684	6086	6644	6986	8030	2.00	36	
 <b>NEV/B/1700/3/ABW</b>	Three upholstered seat pads	6474	6550	6640	6700	6806	6882	7018	7168	7364	7544	6616	7454	7966	9532	3.00	54	

**78" (2000MM)  
WIDTH ABW**

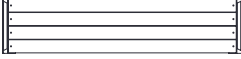
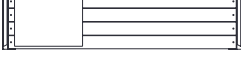
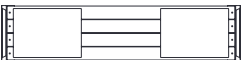

Code:	Description	COM /1	2	3	4	5	6	7	8	9	10	COL	L1	L2	L3	(ly)	(ft <sup>2</sup> )	(lb)
 <b>NEV/B/2000/T/ABW</b>	Timber Bench No seat pads	5236	-	-	-	-	-	-	-	-	-	-	-	-	-	-	-	-
 <b>NEV/B/2000/1/ABW</b>	One Upholstered End pad (L or R)	5734	5760	5790	5810	5846	5872	5918	5968	6034	6094	5818	6098	6268	6790	1.00	18	
 <b>NEV/B/2000/2E/ABW</b>	Two Upholstered End Pads	6234	6284	6344	6384	6454	6504	6594	6694	6824	6944	6348	6906	7248	8292	2.00	36	
 <b>NEV/B/2000/2M/ABW</b>	Two Upholstered Mid Pads	6234	6284	6344	6384	6454	6504	6594	6694	6824	6944	6348	6906	7248	8292	2.00	36	
 <b>NEV/B/2000/3/ABW</b>	Three upholstered seat pads	6732	6808	6898	6958	7064	7140	7276	7426	7622	7802	6878	7716	8228	9794	3.00	54	

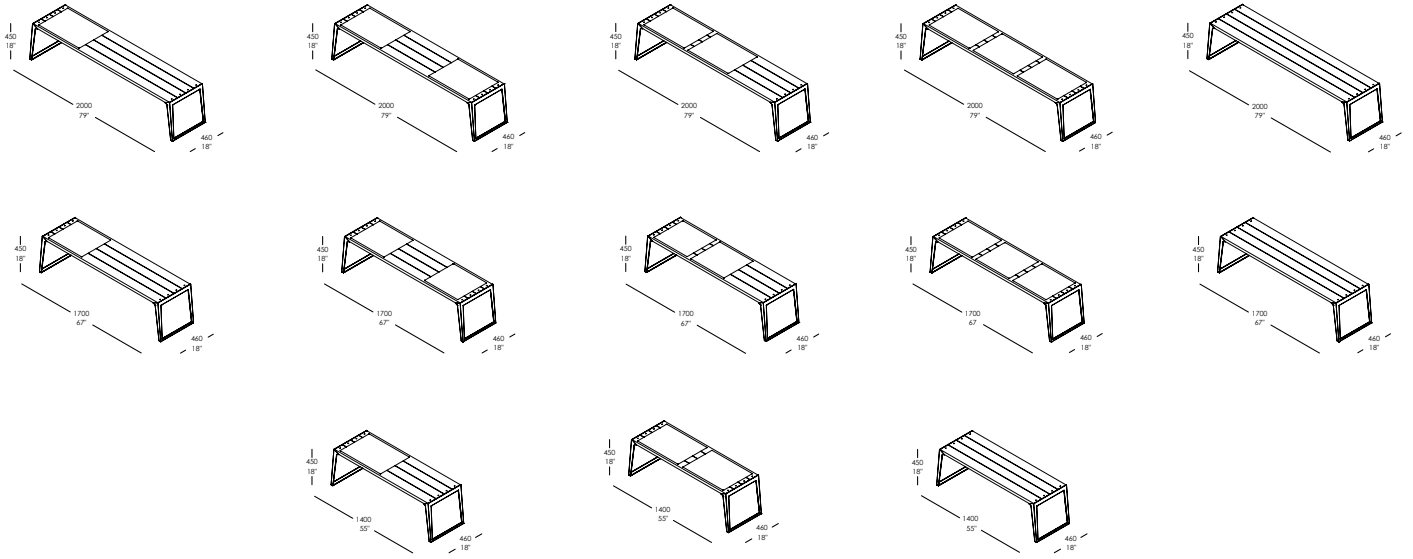

BENCHES



# Ola

Chairs & Stools Collection

boss



The monoshell collection which epitomises European design. It combines beauty with a variety of materials, without compromising its ergonomically engineered comfort.

This beautifully curved multi-purpose chair sits perfectly in a range of workplace Habitats, such as work cafés, formal meeting spaces or breakout areas.

Designed by Wolfgang C.R. Mezger





## Range Information

- Choice of eight plastic shell and frame colors
- Choice of two wood veneers
- Upholstered seat pad - plastic and wood
- Full Upholstered liner - Wood Only
- Plush version is also available  
Plush leather version only available in the Crest Shelly range
- Custom RAL colors are also available based on a MOQ of 20 pieces of seat and frames. (Extended Lead time applies)
- **To ensure the highest quality finish, OLA fully upholstered and upholstered liner is only available in the following fabric options:**
  - Camira Aquarius
  - Camira Blazer
  - Camira Synergy
  - Camira Xtreme
  - Kvadrat Merit
  - Kvadrat Remix
  - Kvadrat Rime
  - Kvadrat Steelcut Trio 3
- Only the seat pad option can be upholstered in any fabric or leather.
- Skai Sotega vinyl is available on Ola Plush seating option only
- Stacking trolley available for stackable units. Stacks a maximum of 12 high (plastic seat and back only).
- Fully Upholstered floor stacks 6 high  
Plush Upholstered floor Stacks 4 high
- Plush not suitable for trolley stacking



**OLA/1  
4 LEG FRAME**



**DIMENSIONS**  
 Height: **850mm (33.5")**  
 Width: **605mm (24")**  
 Depth: **540mm (21")**  
 Seat Height: **445mm (17.5")**  
 Seat Depth: **540mm (21")**  
 Arm Height: **675mm (26.5")**

Code:	Description	\$	(lb)
<b>BPS BPF</b>	Black Plastic Shell, black frame	422	
<b>BPS PF</b>	Black Plastic Shell, Colored frame	432	
<b>BPS CF</b>	Black Plastic Shell, Chrome Frame	450	
<b>PS BPF</b>	Colored plastic shell, black frame	468	
<b>PS PF</b>	Colored plastic shell, colored frame	480	
<b>PS CF</b>	Colored plastic shell, chrome frame	498	
<b>OVS BPF</b>	Oak Veneer Shell, Black frame	1008	
<b>OVS PF</b>	Oak Veneer Shell, Colored frame	1016	
<b>OVS CF</b>	Oak Veneer Shell, chrome frame	1036	
<b>WVS BPF</b>	Walnut Veneer Shell, Black frame	1024	
<b>WVS PF</b>	Walnut veneer shell, colored frame	1032	
<b>WVS CF</b>	Walnut Veneer shell, chrome frame	1050	

CHAIRS & STOOLS

Fabric Linear Yard Leather Square Footage Product Weight

**Painted Frame Options**

Color Choice	RAL 9005	RAL 9016	RAL 060 60 05	RAL 240 20 22	RAL 220 70 10	RAL 130 30 20	RAL 040 50 50	RAL 070 70 80
Suffix*	PF/B	PF/W	PF/SG	PF/DB	PF/LB	PF/GN	PF/CR	PF/Y
\$	\$inc	\$inc	\$inc	\$inc	\$inc	\$inc	\$inc	\$inc

**Options**

CODE:	DESCRIPTION	COM /1	2	3	4	5	6	7	8	9	10	COL	L1	L2	L3	(ly)	(ft²)
<b>US</b>	Upholstered Seat pad	168	182	198	208	226	240	264	290	324	354	184	324	410	670	0.50	9.00
<b>USB</b>	"Upholstered full seat & back liner (not available on plastic shell)"	250	276	306	326	362	388	434	484	550	610	280	560	730	1,252	1.00	18.00
<b>FU</b>	Fully Upholstered	172	210	256	286	340	378	446	522	620	710	-	-	-	-	1.50	27.00
<b>Plush</b>	Fully Upholstered - Plush	234	280	334	370	434	480	562	652	770	878	-	-	-	-	1.80	32.40
<b>LA</b>	Loop Arm - Black as Standard	132	-	-	-	-	-	-	-	-	-	-	-	-	-	-	-
<b>A</b>	Black Plastic Arms	106	-	-	-	-	-	-	-	-	-	-	-	-	-	-	-
<b>Stacking</b>	Stacking Trolley - Stacks up to 12 high	966	-	-	-	-	-	-	-	-	-	-	-	-	-	-	-

**OLA/2  
SLED BASE**

	Code:	Description	\$	(lb)
 <p><b>DIMENSIONS</b>            Height: <b>850mm (33.5")</b>            Width: <b>605mm (24")</b>            Depth: <b>540mm (21")</b>            Seat Height: <b>445mm (17.5")</b>            Seat Depth: <b>540mm (21")</b>            Arm Height: <b>675mm (26.5")</b></p>	<b>BPS BPF</b>	Black Plastic Shell, black frame	472	
	<b>BPS PF</b>	Black Plastic Shell, Colored frame	476	
	<b>BPS CF</b>	Black Plastic Shell, Chrome Frame	512	
	<b>PS BPF</b>	Colored plastic shell, black frame	520	
	<b>PS PF</b>	Colored plastic shell, colored frame	526	
	<b>PS CF</b>	Colored plastic shell, chrome frame	554	
	<b>OVS BPF</b>	Oak Veneer Shell, Black frame	1046	
	<b>OVS PF</b>	Oak Veneer Shell, Colored Frame	1050	
	<b>OVS CF</b>	Oak Veneer Shell, chrome frame	1086	
	<b>WVS BPF</b>	Walnut Veneer Shell, Black frame	1076	
	<b>WVS PF</b>	Walnut veneer shell, colored frame	1080	
	<b>WVS CF</b>	Walnut Vneer shell, chrome frame	1112	

 Fabric Linear Yard  Leather Square Footage  Product Weight



**Painted Frame Options**

Color Choice	RAL 9005	RAL 9016	RAL 060 60 05	RAL 240 20 22	RAL 220 70 10	RAL 130 30 20	RAL 040 50 50	RAL 070 70 80
Suffix*	PF/B	PF/W	PF/SG	PF/DB	PF/LB	PF/GN	PF/CR	PF/Y
\$	\$inc	\$inc	\$inc	\$inc	\$inc	\$inc	\$inc	\$inc

**Options**

CODE:	DESCRIPTION	COM /1	2	3	4	5	6	7	8	9	10	COL	L1	L2	L3	(ly)	(ft <sup>2</sup> )
<b>US</b>	Upholstered Seat pad	168	182	198	208	226	240	264	290	324	354	184	324	410	670	0.50	9.00
<b>USB</b>	"Upholstered full seat & back liner (not available on plastic shell)"	250	276	306	326	362	388	434	484	550	610	280	560	730	1,252	1.00	18.00
<b>FU</b>	Fully Upholstered	172	210	256	286	340	378	446	522	620	710	-	-	-	-	1.50	27.00
<b>Plush</b>	Fully Upholstered - Plush	234	280	334	370	434	480	562	652	770	878	-	-	-	-	1.80	32.40
<b>A</b>	Plastic Arm - Black as standard	106	-	-	-	-	-	-	-	-	-	-	-	-	-	-	-
<b>Stacking</b>	Stacking Trolley - Stacks up to 12 high	966	-	-	-	-	-	-	-	-	-	-	-	-	-	-	-

**OLA/4**  
**HIGH 4 STAR FIXED BASE**

	Code:	Description	\$	(lb)
  	<b>BPS BPF</b>	Black Plastic Shell, black frame	658	
	<b>BPS PF</b>	Black Plastic Shell, Colored frame	904	
	<b>BPS CF</b>	Black Plastic Shell, Chrome Frame	672	
	<b>PS BPF</b>	Colored plastic shell, black frame	710	
	<b>PS PF</b>	Colored plastic shell, colored frame	956	
	<b>PS CF</b>	Colored plastic shell, chrome frame	724	
	<b>OVS BPF</b>	Oak Veneer Shell, Black frame	1276	
	<b>OVS PF</b>	Oak Veneer Shell, Colored Frame	1518	
	<b>OVS CF</b>	Oak Veneer Shell, chrome frame	1288	
	<b>WVS BPF</b>	Walnut Veneer Shell, Black frame	1292	
	<b>WVS PF</b>	Walnut veneer shell, colored frame	1536	
	<b>WVS CF</b>	Walnut Veneer shell, chrome frame	1308	

**DIMENSIONS**  
 Height: **855mm (33.5")**  
 Width: **700mm (27.25")**  
 Depth: **700mm (27.25")**  
 Seat Height: **445mm (17.5")**  
 Seat Depth: **540mm (21")**

CHAIRS & STOOLS

 Fabric Linear Yard  Leather Square Footage  Product Weight

**Painted Frame Options**

Color Choice	RAL 9005	RAL 9016	RAL 060 60 05	RAL 240 20 22	RAL 220 70 10	RAL 130 30 20	RAL 040 50 50	RAL 070 70 80
Suffix*	PF/B	PF/W	PF/SG	PF/DB	PF/LB	PF/GN	PF/CR	PF/Y
\$	\$inc	\$inc	\$inc	\$inc	\$inc	\$inc	\$inc	\$inc

**Options**

CODE:	DESCRIPTION	COM /1	2	3	4	5	6	7	8	9	10	COL	L1	L2	L3	(ly)	(ft²)
<b>US</b>	Upholstered Seat pad	168	182	198	208	226	240	264	290	324	354	184	324	410	670	0.50	9.00
<b>USB</b>	Upholstered full seat & back liner (not available on plastic shell)	250	276	306	326	362	388	434	484	550	610	280	560	730	1,252	1.00	18.00
<b>FU</b>	Fully Upholstered	172	210	256	286	340	378	446	522	620	710	-	-	-	-	1.50	27.00
<b>Plush</b>	Fully Upholstered - Plush	234	280	334	370	434	480	562	652	770	878	-	-	-	-	1.80	32.40

**OLA/4/HA/TM-B**  
**LOW 4 STAR BASE, HEIGHT ADJUSTABLE**  
**WITH TILT MECHANISM**



**DIMENSIONS**

Height: **755-875mm (30-34.5")**  
 Width: **720mm (28.5")**  
 Depth: **585mm (23")**  
 Seat Height: **350-470mm (14-18.5")**  
 Seat Depth: **560mm (22")**  
 Arm Height: **650-770mm (26-30.25")**  
 Black Castors as Standard

Code:	Description	\$	(lb)
<b>BPS BPF</b>	Black Plastic Shell, black frame with black tilt mechanism	648	
<b>BPS CF</b>	Black Plastic Shell, Polished Frame with black tilt mechanism	648	
<b>PS BPF</b>	Colored plastic shell, black frame with black tilt mechanism	698	
<b>PS CF</b>	Colored plastic shell, polished frame with black tilt mechanism	698	
<b>OVS BPF</b>	Oak Veneer Shell, Black frame with black tilt mechanism	1268	
<b>OVS CF</b>	Oak Veneer Shell, polished frame with black tilt mechanism	1268	
<b>WVS BPF</b>	Walnut Veneer Shell, Black frame with black tilt mechanism	1286	
<b>WVS CF</b>	Walnut Veneer shell, polished frame with black tilt mechanism	1286	

Fabric Linear Yard Leather Square Footage Product Weight

**Options**

CODE:	DESCRIPTION	COM /1	2	3	4	5	6	7	8	9	10	COL	L1	L2	L3	(ly)	(ft <sup>2</sup> )
<b>US</b>	Upholstered Seat pad	168	182	198	208	226	240	264	290	324	354	184	324	410	670	0.50	9.00
<b>USB</b>	Upholstered full seat & back liner (not available on plastic shell)	250	276	306	326	362	388	434	484	550	610	280	560	730	1,252	1.00	18.00
<b>FU</b>	Fully Upholstered	172	210	256	286	340	378	446	522	620	710	-	-	-	-	1.50	27.00
<b>Plush</b>	Fully Upholstered - Plush	234	280	334	370	434	480	562	652	770	878	-	-	-	-	1.80	32.40
<b>*ZA</b>	Z Arm (only available on chairs with upholstery)	210	-	-	-	-	-	-	-	-	-	-	-	-	-	-	-
<b>TM/P</b>	Tilt Mechanism - Polished	76	-	-	-	-	-	-	-	-	-	-	-	-	-	-	-
<b>SC</b>	Silver Castors	72	-	-	-	-	-	-	-	-	-	-	-	-	-	-	-

\*\*If selecting an arm, a tilt mechanism will be substituted in place of the spider base - available in black RAL 9005 or polished. The underseat colour is available in any of the 8 standard RAL Colours, however if not specified at point of order, RAL 060 60 05 will be used with a polished mechanism and RAL 9005 with a black mechanism

**OLA/4/HA**  
**LOW 4 STAR BASE**  
**HEIGHT ADJUSTABLE ONLY**



**DIMENSIONS**

Height: **755-875mm (30-34.5")**  
 Width: **720mm (28.5")**  
 Depth: **585mm (23")**  
 Seat Height: **350-470mm (14-18.5")**  
 Seat Depth: **560mm (22")**

Black Castors as Standard

Code:	Description	\$	(lb)
<b>BPS BPF</b>	Black Plastic Shell, black frame	648	
<b>BPS CF</b>	Black Plastic Shell, Polished Frame	648	
<b>PS BPF</b>	Colored plastic shell, black frame	698	
<b>PS CF</b>	Colored plastic shell, polished frame	698	
<b>OVS BPF</b>	Oak Veneer Shell, Black frame	1268	
<b>OVS CF</b>	Oak Veneer Shell, polished frame	1268	
<b>WVS BPF</b>	Walnut Veneer Shell, Black frame	1286	
<b>WVS CF</b>	Walnut Veneer shell, polished frame	1286	

CHAIRS & STOOLS

Fabric Linear Yard Leather Square Footage Product Weight

**Options**

CODE:	DESCRIPTION	COM /1	2	3	4	5	6	7	8	9	10	COL	L1	L2	L3	(ly)	(ft²)
<b>US</b>	Upholstered Seat pad	168	182	198	208	226	240	264	290	324	354	184	324	410	670	0.50	9.00
<b>USB</b>	Upholstered full seat & back liner (not available on plastic shell)	250	276	306	326	362	388	434	484	550	610	280	560	730	1,252	1.00	18.00
<b>FU</b>	Fully Upholstered	172	210	256	286	340	378	446	522	620	710	-	-	-	-	1.50	27.00
<b>Plush</b>	Fully Upholstered - Plush	234	280	334	370	434	480	562	652	770	878	-	-	-	-	1.80	32.40
<b>SC</b>	Silver Castors	72	-	-	-	-	-	-	-	-	-	-	-	-	-	-	-

**OLA/5/HA/TM-B**  
**5 STAR BASE HEIGHT ADJUSTABLE WITH**  
**TILT MECHANISM**



**DIMENSIONS**

Height: **755-875mm (30-34.5")**  
 Width: **615mm (24.25")**  
 Depth: **585mm (23")**  
 Seat Height: **350-470mm (14-18.5")**  
 Seat Depth: **560mm (22")**  
 Arm Height: **650-770mm (26-30.25")**  
 Tablet: **660-780mm (30-30.75")**

Code:	Description	\$	(lb)
<b>BPS BPF</b>	Black Plastic Shell, black frame with black tilt mechanism	606	
<b>BPS CF</b>	Black Plastic Shell, Polished Frame with black tilt mechanism	626	
<b>PS BPF</b>	Colored plastic shell, black frame with black tilt mechanism	658	
<b>PS CF</b>	Colored plastic shell, polished frame with black tilt mechanism	710	
<b>OVS BPF</b>	Oak Veneer Shell, Black frame with black tilt mechanism	1224	
<b>OVS CF</b>	Oak Veneer Shell, polished frame with black tilt mechanism	1240	
<b>WVS BPF</b>	Walnut Veneer Shell, Black frame with black tilt mechanism	1240	
<b>WVS CF</b>	Walnut Veneer shell, polished frame with black tilt mechanism	1260	

Fabric Linear Yard Leather Square Footage Product Weight

**Options**

CODE:	DESCRIPTION	COM /1	2	3	4	5	6	7	8	9	10	COL	L1	L2	L3	(ly)	(ft <sup>2</sup> )
<b>US</b>	Upholstered Seat pad	168	182	198	208	226	240	264	290	324	354	184	324	410	670	0.50	9.00
<b>USB</b>	Upholstered full seat & back liner (not available on plastic shell)	250	276	306	326	362	388	434	484	550	610	280	560	730	1,252	1.00	18.00
<b>FU</b>	Fully Upholstered	172	210	256	286	340	378	446	522	620	710	-	-	-	-	1.50	27.00
<b>Plush</b>	Fully Upholstered - Plush	234	280	334	370	434	480	562	652	770	878	-	-	-	-	1.80	32.40
<b>*ZA</b>	Z Arm (only available on chairs with upholstery)	210	-	-	-	-	-	-	-	-	-	-	-	-	-	-	-
<b>TM/P</b>	Tilt Mechanism - Polished	76	-	-	-	-	-	-	-	-	-	-	-	-	-	-	-
<b>SC</b>	Silver Castors	72	-	-	-	-	-	-	-	-	-	-	-	-	-	-	-

\*\*If selecting an arm, a tilt mechanism will be substituted in place of the spider base - available in black RAL 9005 or polished. The underseat color is available in any of the 8 standard RAL Colors, however if not specified at point of order, RAL 060 60 05 will be used with a polished mechanism and RAL 9005 with a black mechanism

**OLA/5/HA**  
**5 STAR BASE,**  
**HEIGHT ADJUSTABLE ONLY**



**DIMENSIONS**

Height: **755-875mm (30-34.5")**  
 Width: **615mm (24.25")**  
 Depth: **585mm (23")**  
 Seat Height: **350-470mm (14-18.5")**  
 Seat Depth: **560mm (22")**  
 Arm Height: **650-770mm (26-30.25")**  
 Tablet: **660-780mm (30-30.75")**

Code:	Description	\$	(lb)
<b>BPS BPF</b>	Black Plastic Shell, black frame	606	
<b>BPS CF</b>	Black Plastic Shell, Polished Frame	626	
<b>PS BPF</b>	Colored plastic shell, black frame	658	
<b>PS CF</b>	Colored plastic shell, polished frame	710	
<b>OVS BPF</b>	Oak Veneer Shell, Black frame	1224	
<b>OVS CF</b>	Oak Veneer Shell, polished frame	1240	
<b>WVS BPF</b>	Walnut Veneer Shell, Black frame	1240	
<b>WVS CF</b>	Walnut Veneer shell, polished frame	1260	

CHAIRS & STOOLS

Fabric Linear Yard Leather Square Footage Product Weight

**Options**

CODE:	DESCRIPTION	COM /1	2	3	4	5	6	7	8	9	10	COL	L1	L2	L3	(ly)	(ft²)
<b>US</b>	Upholstered Seat pad	168	182	198	208	226	240	264	290	324	354	184	324	410	670	0.50	9.00
<b>USB</b>	Upholstered full seat & back liner (not available on plastic shell)	250	276	306	326	362	388	434	484	550	610	280	560	730	1,252	1.00	18.00
<b>FU</b>	Fully Upholstered	172	210	256	286	340	378	446	522	620	710	-	-	-	-	1.50	27.00
<b>Plush</b>	Fully Upholstered - Plush	234	280	334	370	434	480	562	652	770	878	-	-	-	-	1.80	32.40
<b>WT</b>	Writing Tablet	470	-	-	-	-	-	-	-	-	-	-	-	-	-	-	-
<b>SC</b>	Silver Castors	72	-	-	-	-	-	-	-	-	-	-	-	-	-	-	-

**OLA/6**  
HEIGHT ADJUSTABLE CASHIER CHAIR



**DIMENSIONS**

Width: **470mm (18.5")**  
 Depth: **540mm (21")**  
 Seat Height: **570-770mm (22.5-30.5")**  
 Seat Depth: **560mm (22")**

Code:	Description	\$	(lb)
<b>BPS BPF</b>	Black Plastic Shell, black frame	736	
<b>BPS CF</b>	Black Plastic Shell, Polished Frame	740	
<b>PS BPF</b>	Colored plastic shell, black frame	810	
<b>PS CF</b>	Colored plastic shell, polished frame	816	
<b>OVS BPF</b>	Oak Veneer Shell, Black frame	1408	
<b>OVS CF</b>	Oak Veneer Shell, polished frame	1410	
<b>WVS BPF</b>	Walnut Veneer Shell, Black frame	1424	
<b>WVS CF</b>	Walnut veneer shell, polished frame	1466	

Fabric Linear Yard Leather Square Footage Product Weight

**Options**

CODE:	DESCRIPTION	COM /1	2	3	4	5	6	7	8	9	10	COL	L1	L2	L3	(ly)	(ft²)
<b>US</b>	Upholstered Seat pad	168	182	198	208	226	240	264	290	324	354	184	324	410	670	0.50	9.00
<b>USB</b>	Upholstered full seat & back liner (not available on plastic shell)	250	276	306	326	362	388	434	484	550	610	280	560	730	1,252	1.00	18.00
<b>FU</b>	Fully Upholstered	172	210	256	286	340	378	446	522	620	710	-	-	-	-	1.50	27.00
<b>Plush</b>	Fully Upholstered - Plush	234	280	334	370	434	480	562	652	770	878	-	-	-	-	1.80	32.40
<b>SC</b>	Silver Castors	72	-	-	-	-	-	-	-	-	-	-	-	-	-	-	-

**OLA/7**  
**FOUR LEG BAR STOOL**



**DIMENSIONS**

Height: **1150mm (45.25")**  
 Width: **470mm (18.5")**  
 Depth: **540mm (21")**  
 Seat Height: **735mm (29")**  
 Seat Depth: **560mm (22")**

Code:	Description	\$	(lb)
<b>BPS BPF</b>	Black Plastic Shell, black frame	576	
<b>BPS PF</b>	Black Plastic Shell, Colored frame	582	
<b>BPS CF</b>	Black Plastic Shell, Chrome Frame	624	
<b>PS BPF</b>	Colored plastic shell, black frame	636	
<b>PS PF</b>	Colored plastic shell, colored frame	642	
<b>PS CF</b>	Colored plastic shell, chrome frame	674	
<b>OVS BPF</b>	Oak Veneer Shell, Black frame	1206	
<b>OVS PF</b>	Oak Veneer Shell, Colored Frame	1208	
<b>OVS CF</b>	Oak Veneer Shell, chrome frame	1250	
<b>WVS BPF</b>	Walnut Veneer Shell, Black frame	1216	
<b>WVS PF</b>	Walnut veneer shell, colored frame	1220	
<b>WVS CF</b>	Walnut veneer shell, chrome frame	1258	
<b>CH/BPS BPF</b>	Black Plastic Shell, black frame, Counter height	576	
<b>CH/BPS PF</b>	Black Plastic Shell, Colored frame, Counter height	582	
<b>CH/BPS CF</b>	Black Plastic Shell, Chrome Frame, Counter height	624	
<b>CH/PS BPF</b>	Colored plastic shell, black frame, Counter height	636	
<b>CH/PS PF</b>	Colored plastic shell, colored frame, Counter height	642	
<b>CH/PS CF</b>	Colored plastic shell, chrome frame, Counter height	674	
<b>CH/OVS BPF</b>	Oak Veneer Shell, Black frame, Counter height	1206	
<b>CH/OVS PF</b>	Oak Veneer Shell, Colored Frame, Counter height	1208	
<b>CH/OVS CF</b>	Oak Veneer Shell, chrome frame, Counter height	1250	
<b>CH/WVS BPF</b>	Walnut Veneer Shell, Black frame, Counter height	1216	
<b>CH/WVS PF</b>	Walnut veneer shell, colored frame, Counter height	1220	
<b>CH/WVS CF</b>	Walnut veneer shell, chrome frame, Counter height	1258	

**DIMENSIONS**

Height: **1070mm (42.25")**  
 Width: **470mm (18.5")**  
 Depth: **540mm (21")**  
 Seat Height: **660mm (26")**  
 Seat Depth: **560mm (22")**

CHAIRS & STOOLS

**Painted Frame Options**

Fabric Linear Yard Leather Square Footage Product Weight

Color Choice	RAL 9005	RAL 9016	RAL 060 60 05	RAL 240 20 22	RAL 220 70 10	RAL 130 30 20	RAL 040 50 50	RAL 070 70 80
Suffix*	PF/B	PF/W	PF/SG	PF/DB	PF/LB	PF/GN	PF/CR	PF/Y
\$	\$inc	\$inc	\$inc	\$inc	\$inc	\$inc	\$inc	\$inc

**Options**

CODE:	DESCRIPTION	COM /1	2	3	4	5	6	7	8	9	10	COL	L1	L2	L3	(ly)	(ft <sup>2</sup> )
<b>US</b>	Upholstered Seat pad	168	182	198	208	226	240	264	290	324	354	184	324	410	670	0.50	9.00
<b>USB</b>	Upholstered full seat & back liner (not available on plastic shell)	250	276	306	326	362	388	434	484	550	610	280	560	730	1,252	1.00	18.00
<b>FU</b>	Fully Upholstered	172	210	256	286	340	378	446	522	620	710	-	-	-	-	1.50	27.00
<b>FU Plush</b>	Fully Upholstered - Plush	234	280	334	370	434	480	562	652	770	878	-	-	-	-	1.80	32.40

**Shell Color Options**



**Black**  
RAL 9005



**White**  
RAL 9016



**Light Grey**  
RAL 060 60 05



**Dark Blue**  
RAL 240 20 22



**Light Blue**  
RAL 220 70 10



**Green**  
RAL 130 30 20



**Coral**  
RAL 040 50 50



**Yellow**  
RAL 070 70 80



# Paloma

Meeting & Lounge Chair Collection

boss



Crafted contours enhanced by beautiful upholstery. With its essential quality and timeless design, Paloma is tailor-made for the modern workspace.



CHAIRS





## Range Information

- Paloma is available in two styles:  
Meeting (PAL)  
Lounge (PLL)
- The lounge chair is also available in a Plush style (PLP)
- Available with a variety of base frames:  
Steel four leg, Steel sled, Aluminum four star, Aluminum mobile four star, Nylon five star with castors
- Timber four leg with clear lacquer is also available. This can be stained to a black or white finish
- Metal base frames available in any of the standard 8 Boss RAL colors.
- Not recommended to be upholstered in Grade 1 fabrics



**PAL/1**  
MEETING CHAIR, STEEL FOUR  
LEG PAINTED BASE

**Code:**      **Description**      **COM**    **2**    **3**    **4**    **5**    **6**    **7**    **8**    **9**    **10**    **COL**    **L1**    **L2**    **L3**



**PAL/1**  
Painted 4 leg  
base, available  
in any of the 8  
standard painted  
frame options.  
  
(see table below)

1460 1510 1570 1610 1680 1730 1820 1920 2050 2170 1526 2084 2426 3470

2.00 36

**DIMENSIONS**

Height: **790mm (31.25")**  
Width: **645mm (25.5")**  
Depth: **620mm (24.25")**  
Seat Height: **460mm (18.25")**  
Seat Depth: **460mm (18")**

**PAL/2**  
MEETING CHAIR, STEEL PAINT-  
ED SLED BASE

**Code:**      **Description**      **COM**    **2**    **3**    **4**    **5**    **6**    **7**    **8**    **9**    **10**    **COL**    **L1**    **L2**    **L3**



**PAL/2**  
Painted sled  
base, available  
in any of the 8  
standard painted  
frame options.  
  
(see table below)

1518 1568 1628 1668 1738 1788 1878 1978 2108 2228 1584 2142 2484 3528

2.00 36

**DIMENSIONS**

Height: **790mm (31.25")**  
Width: **645mm (25.5")**  
Depth: **620mm (24.25")**  
Seat Height: **460mm (18.25")**  
Seat Depth: **460mm (18")**

CHAIRS

N.B. Leather is a natural material which will crease and 'puddle'.

Fabric Linear Yard    Leather Square Footage    Product Weight

**PAL/1 & PAL/2 - Painted Base Options**

Color Choice	RAL 9005	RAL 9016	RAL 060 60 05	RAL 240 20 22	RAL 220 70 10	RAL 130 30 20	RAL 040 50 50	RAL 070 70 80
Suffix*	PF/B	PF/W	PF/SG	PF/DB	PF/LB	PF/GN	PF/CR	PF/Y
\$	\$inc	\$inc	\$inc	\$inc	\$inc	\$inc	\$inc	\$inc

**PAL/3**  
MEETING CHAIR, OAK  
LACQUERED BASE

Code:	Description	COM	2	3	4	5	6	7	8	9	10	COL	L1	L2	L3	(ly)	(ft <sup>2</sup> )	(lb)	
PAL/3	Clear lacquered Oak timber base	/1	1928	1978	2038	2078	2148	2198	2288	2388	2518	2638	1998	2556	2898	3942	2.00	36	



**DIMENSIONS**

Height: 790mm (31.25")  
 Width: 645mm (25.5")  
 Depth: 620mm (24.25")  
 Seat Height: 460mm (18.25")  
 Seat Depth: 460mm (18")

**PAL/4**  
MEETING CHAIR, POLISHED  
FOUR STAR BASE

Code:	Description	COM	2	3	4	5	6	7	8	9	10	COL	L1	L2	L3	(ly)	(ft <sup>2</sup> )	(lb)	
PAL/4	Polished aluminum four star base, available in any of the 8 standard painted base options.	/1	1532	1582	1642	1682	1752	1802	1892	1992	2122	2242	1598	2156	2498	3542	2.00	36	



**DIMENSIONS**





Height: 790mm (31.25")  
 Width: 645mm (25.5")  
 Depth: 620mm (24.25")  
 Seat Height: 460mm (18.25")  
 Seat Depth: 460mm (18")





N.B. Leather is a natural material which will crease and 'puddle'.

Fabric Linear Yard Leather Square Footage Product Weight

**PAL/4 - Painted Frame Options**

Color Choice	RAL 9005	RAL 9016	RAL 060 60 05	RAL 240 20 22	RAL 220 70 10	RAL 130 30 20	RAL 040 50 50	RAL 070 70 80
Suffix*	PF/B	PF/W	PF/SG	PF/DB	PF/LB	PF/GN	PF/CR	PF/Y
+\$	160	160	160	160	160	160	160	160

<b>PAL/4/HAT</b> <b>POLISHED FOUR STAR BASE,</b> <b>HEIGHT ADJUSTABLE,</b> <b>TILT MECH</b>	<b>Code:</b>	<b>Description</b>	<b>COM</b>	<b>2</b>	<b>3</b>	<b>4</b>	<b>5</b>	<b>6</b>	<b>7</b>	<b>8</b>	<b>9</b>	<b>10</b>	<b>COL</b>	<b>L1</b>	<b>L2</b>	<b>L3</b>	 (ly)	 (ft <sup>2</sup> )	 (lb)
	<b>PAL/4/HAT</b>	Polished aluminum four star base, with height adjustable tilt mechanism	1566	1616	1676	1716	1786	1836	1926	2026	2156	2276	1634	2192	2534	3578	2.00	36	
<b>DIMENSIONS</b> Height: <b>790mm (31.25")</b> Width: <b>645mm (25.5")</b> Depth: <b>675mm (26.5")</b> Seat Height: <b>440-560mm (14-22")</b> Seat Depth: <b>460mm (18")</b>																			

<b>PAL/5/HAT</b> <b>NYLON FIVE STAR BASE,</b> <b>HEIGHT ADJUSTABLE,</b> <b>TILT MECH</b>	<b>Code:</b>	<b>Description</b>	<b>COM</b>	<b>2</b>	<b>3</b>	<b>4</b>	<b>5</b>	<b>6</b>	<b>7</b>	<b>8</b>	<b>9</b>	<b>10</b>	<b>COL</b>	<b>L1</b>	<b>L2</b>	<b>L3</b>	 (ly)	 (ft <sup>2</sup> )	 (lb)
	<b>PAL/5/HAT</b>	Black Nylon five star base, with height adjustable tilt mechanism	1452	1502	1562	1602	1672	1722	1812	1912	2042	2162	1518	2076	2418	3462	2.00	36	
<b>DIMENSIONS</b> Height: <b>790mm (31.25")</b> Width: <b>645mm (25.5")</b> Depth: <b>675mm (26.5")</b> Seat Height: <b>440-560mm (14-22")</b> Seat Depth: <b>460mm (18")</b>																			

CHAIRS

N.B. Leather is a natural material which will crease and 'puddle'.

 Fabric Linear Yard  Leather Square Footage  Product Weight

**PAL/4/HAT - Painted Frame Options**

<b>Color Choice</b>	<b>RAL 9005</b>
<b>Suffix*</b>	<b>PF/B</b>
<b>\$</b>	<b>\$inc</b>

**PLL/1  
LOUNGE CHAIR, STEEL FOUR  
LEG PAINTED FRAME**

Code:	Description	COM /1	2	3	4	5	6	7	8	9	10	COL	L1	L2	L3	(ly)	(ft <sup>2</sup> )	(lb)
PLL/1	Painted steel four leg frame, available in any of the 8 standard painted frame options.  (see table below)	1738	1796	1864	1910	1990	2048	2150	2264	2412	2548	1814	2450	2840	4028	2.25	41	



**DIMENSIONS**

Height: 755mm (29.75")  
 Width: 710mm (28")  
 Depth: 680mm (26.75")  
 Seat Height: 440mm (17.5")  
 Seat Depth: 510mm (20")  
 Arm Height: 555mm (22")

**PLL/2  
LOUNGE CHAIR,  
STEEL PAINTED SLED BASE**

Code:	Description	COM /1	2	3	4	5	6	7	8	9	10	COL	L1	L2	L3	(ly)	(ft <sup>2</sup> )	(lb)
PLL/2	Painted sled base, available in any of the 8 standard painted frame options.  (see table below)	1772	1830	1898	1944	2024	2082	2184	2298	2446	2582	1850	2486	2876	4064	2.25	41	



**DIMENSIONS**

Height: 755mm (29.75")  
 Width: 710mm (28")  
 Depth: 680mm (26.75")  
 Seat Height: 440mm (17.5")  
 Seat Depth: 510mm (20")  
 Arm Height: 555mm (22")

N.B. Leather is a natural material which will crease and 'puddle'.

Fabric Linear Yard Leather Square Footage Product Weight

**PLL/ 1 & PLL/2 - Painted Frame Options**

Color Choice	RAL 9005	RAL 9016	RAL 060 60 05	RAL 240 20 22	RAL 220 70 10	RAL 130 30 20	RAL 040 50 50	RAL 070 70 80
Suffix*	PF/B	PF/W	PF/SG	PF/DB	PF/LB	PF/GN	PF/CR	PF/Y
\$	\$inc	\$inc	\$inc	\$inc	\$inc	\$inc	\$inc	\$inc

PLL/3 LOUNGE CHAIR, OAK LACQUERED BASE	Code:	Description	COM /1	2	3	4	5	6	7	8	9	10	COL	L1	L2	L3	(ly)	(ft²)	(lb)
	PLL/3	Clear lacquered Oak timber base	2208	2266	2334	2380	2460	2518	2620	2734	2882	3018	2290	2926	3316	4504	2.25	41	

**DIMENSIONS**  
 Height: 755mm (29.75")  
 Width: 710mm (28")  
 Depth: 680mm (26.75")  
 Seat Height: 440mm (17.5")  
 Seat Depth: 510mm (20")  
 Arm Height: 555mm (22")

PLL/4 LOUNGE CHAIR, FOUR STAR BASE	Code:	Description	COM /1	2	3	4	5	6	7	8	9	10	COL	L1	L2	L3	(ly)	(ft²)	(lb)
	PLL/4	Four star polished aluminum base	1764	1822	1890	1936	2016	2074	2176	2290	2438	2574	1842	2478	2868	4056	2.25	41	

**DIMENSIONS**  
 Height: 735mm (29")  
 Width: 710mm (28")  
 Depth: 665mm (26")  
 Seat Height: 440mm (17.5")  
 Seat Depth: 510mm (20")  
 Arm Height: 555mm (22")

LOUNGE CHAIRS

N.B. Leather is a natural material which will crease and 'puddle'.

Fabric Linear Yard Leather Square Footage Product Weight

**PLL/4 - Painted Frame Options**

Color Choice	RAL 9005	RAL 9016	RAL 060 60 05	RAL 240 20 22	RAL 220 70 10	RAL 130 30 20	RAL 040 50 50	RAL 070 70 80
Suffix*	PF/B	PF/W	PF/SG	PF/DB	PF/LB	PF/GN	PF/CR	PF/Y
+\$	160	160	160	160	160	160	160	160

**PLP/1**  
**PLUSH LOUNGE CHAIR, STEEL**  
**FOUR LEG PAINTED FRAME**

Code:	Description	COM	2	3	4	5	6	7	8	9	10	COL	L1	L2	L3	(ly)	(ft <sup>2</sup> )	(lb)
PLP/1	Ruched back detail Painted steel four leg frame, available in any of the 8 standard painted frame options. (see table below)	/1	1916	1974	2042	2088	2168	2226	2328	2442	2590	2726	1994	2630	3020	4208	2.25	41



**DIMENSIONS**

Height: 755mm (29.75")  
 Width: 710mm (28")  
 Depth: 680mm (26.75")  
 Seat Height: 440mm (17.5")  
 Seat Depth: 510mm (20")  
 Arm Height: 555mm (22")

**PLP/2**  
**PLUSH LOUNGE CHAIR, STEEL**  
**PAINTED SLED BASE**

Code:	Description	COM	2	3	4	5	6	7	8	9	10	COL	L1	L2	L3	(ly)	(ft <sup>2</sup> )	(lb)
PLP/2	Ruched back detail Painted sled base, available in any of the 8 standard painted frame options. (see table below)	/1	1950	2008	2076	2122	2202	2260	2362	2476	2624	2760	2030	2666	3056	4244	2.25	41



**DIMENSIONS**

Height: 755mm (29.75")  
 Width: 710mm (28")  
 Depth: 680mm (26.75")  
 Seat Height: 440mm (17.5")  
 Seat Depth: 510mm (20")  
 Arm Height: 555mm (22")

N.B. Leather is a natural material which will crease and 'puddle'. Fabric Linear Yard Leather Square Footage Product Weight

**PLL/ 1 & PLL/2 - Painted Frame Options**

Color Choice	RAL 9005	RAL 9016	RAL 060 60 05	RAL 240 20 22	RAL 220 70 10	RAL 130 30 20	RAL 040 50 50	RAL 070 70 80
Suffix*	PF/B	PF/W	PF/SG	PF/DB	PF/LB	PF/GN	PF/CR	PF/Y
\$	\$inc	\$inc	\$inc	\$inc	\$inc	\$inc	\$inc	\$inc

PLP/3 PLUSH LOUNGE CHAIR, OAK LACQUERED BASE	Code:	Description	COM /1	2	3	4	5	6	7	8	9	10	COL	L1	L2	L3	(ly)	(ft <sup>2</sup> )	(lb)
					PLP/3	Ruched back detail Clear lacquered Oak timber base	2384	2442	2510	2556	2636	2694	2796	2910	3058	3194	2468	3104	3494

**DIMENSIONS**  
 Height: 755mm (29.75")  
 Width: 710mm (28")  
 Depth: 680mm (26.75")  
 Seat Height: 440mm (17.5")  
 Seat Depth: 510mm (20")  
 Arm Height: 555mm (22")

PLP/4 PLUSH LOUNGE CHAIR, FOUR STAR BASE	Code:	Description	COM /1	2	3	4	5	6	7	8	9	10	COL	L1	L2	L3	(ly)	(ft <sup>2</sup> )	(lb)
					PLP/4	Ruched back detail Four star polished aluminum base	1944	2002	2070	2116	2196	2254	2356	2470	2618	2754	2024	2660	3050

**DIMENSIONS**  
 Height: 755mm (29.75")  
 Width: 710mm (28")  
 Depth: 680mm (26.75")  
 Seat Height: 440mm (17.5")  
 Seat Depth: 510mm (20")  
 Arm Height: 555mm (22")

LOUNGE CHAIRS

N.B. Leather is a natural material which will crease and 'puddle'.

Fabric Linear Yard Leather Square Footage Product Weight

**PLP/4 - Painted Frame Options**

Color Choice	RAL 9005	RAL 9016	RAL 060 60 05	RAL 240 20 22	RAL 220 70 10	RAL 130 30 20	RAL 040 50 50	RAL 070 70 80
Suffix*	PF/B	PF/W	PF/SG	PF/DB	PF/LB	PF/GN	PF/CR	PF/Y
+\$	160	160	160	160	160	160	160	160



# Pro

Meeting & Conference Chairs

boss

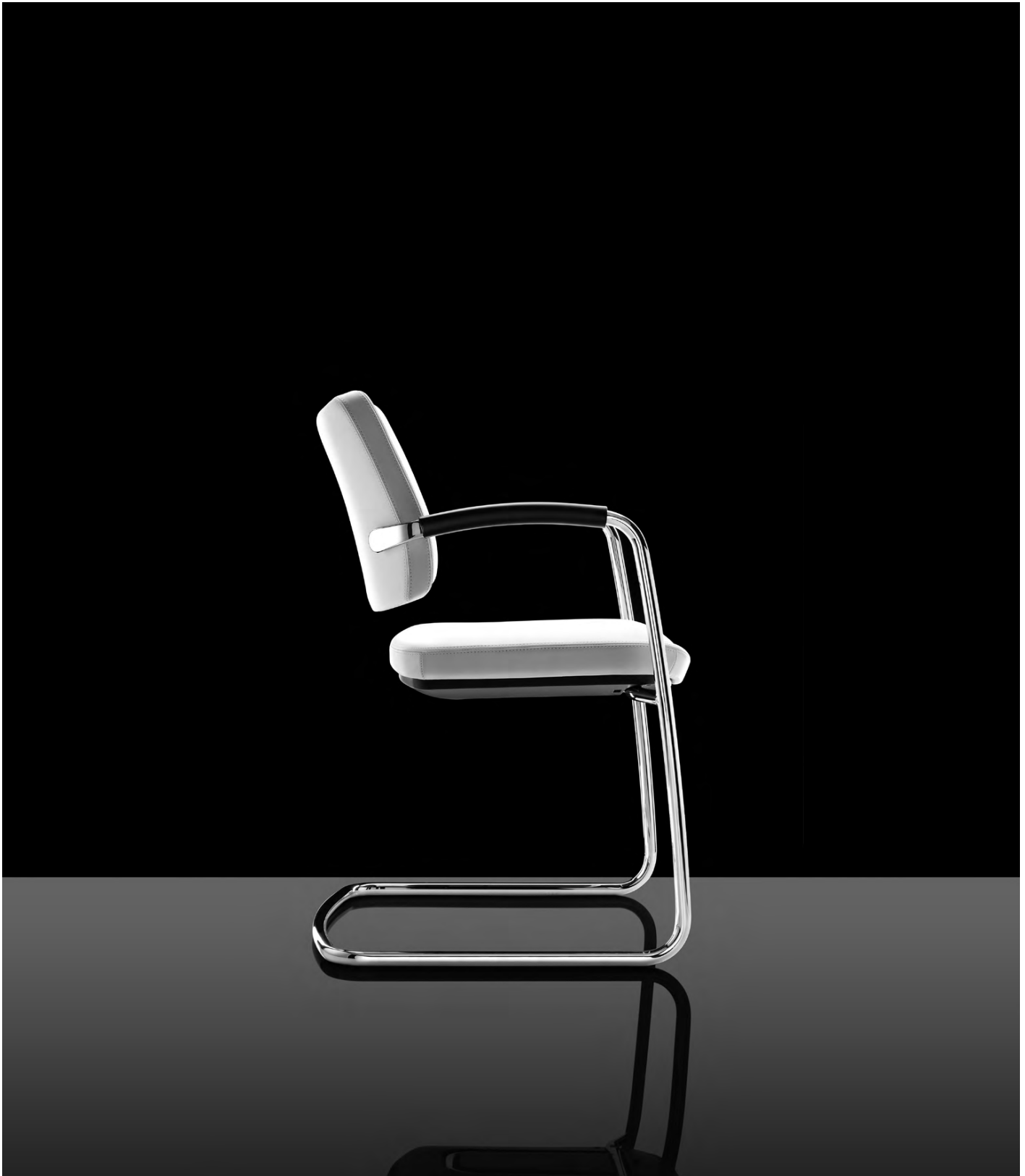

Pro boasts an assured level of comfort and may be specified as a stackable or non-stackable frame. It is also available with a 4-star base or 5-star base with

castors. The Pro chair is the ideal accompanying visitor chair and is equally suited to boardroom, meeting and conference spaces.





## Range Information

- Fully upholstered in any fabric or leather
- CMHR moulded seat and back foams
- Polished cast aluminum knuckle detail
- Hard compound polyurethane arm sleeves
- Chrome base or frame
- Stackable or non-stackable cantilever frame options
- Stackable 3 high



PRO/	Code:	Description	COM /1	2	3	4	5	6	7	8	9	10	COL	L1	L2	L3	(ly)	(ft <sup>2</sup> )	(lb)
 <p><b>DIMENSIONS</b>            Height: <b>845mm (33.25")</b>            Width: <b>555mm (22")</b>            Depth: <b>605mm (23.75")</b>            Seat Height: <b>460mm (18.25")</b>            Seat Depth: <b>460mm (18.25")</b>            Arm Height: <b>685mm (27")</b></p>	<b>PRO/2</b>	Cantilever visitor chair with arms on a chrome non-stacking frame	1054	1086	1124	1150	1194	1226	1284	1348	1430	1506	1098	1456	1674	2340	1.25	23	
	<b>PRO/3</b>	Cantilever visitor chair with arms on a chrome stacking frame	1032	1064	1102	1128	1172	1204	1262	1326	1408	1484	1076	1434	1652	2318	1.25	23	
	<b>PRO/4</b>	Chair with arms on a polished 4 star swivel base	1594	1626	1664	1690	1734	1766	1824	1888	1970	2046	1644	2002	2220	2886	1.25	23	

MEETING & CONFERENCE CHAIRS

N.B. Leather is a natural material which will crease and 'puddle'.

 Fabric Linear Yard  Leather Square Footage  Product Weight

**Options**

CODE:	DESCRIPTION	\$
<b>P5</b>	5 star polished swivel base on castors (additional price to PRO/4)	56



# Rosa

Lounge Seating

boss



The lounge collection that brings a relaxed elegance of outdoor to indoor lounge spaces.

With a light and agile design aesthetic, Rosa combines the flexibility and appeal of al fresco seating with classic lounge comfort.



LOUNGE SEATING







## Range Information

- Lounge Chair & Sofa collection
- Tubular steel frame available in any of the 8 Boss standard RAL colors
- Webbed Seat
- CMHR foam to seat and back
- Available in a wide range of fabrics
- Two-tone fabric options are available - Price on Application
- Glides for easy reconfiguration
- Not recommended to be upholstered in Band 1 fabrics
- Rosa is not available in leather



ROS/1 LOUNGE CHAIR	Code:	Description	COM	1	2	3	4	5	6	7	8	9	10	COL	L1	L2	L3	(ly) (ft²) (lb)
	ROS/1	Lounge chair with painted tubular steel frame	1710	1774	1850	1900	1988	2052	2166	2292	2456	2606	-	-	-	-	2.50	45
	<p><b>DIMENSIONS</b>            Height: <b>785mm (31")</b>            Width: <b>775mm (30.5")</b>            Depth: <b>795mm (31.25")</b>            Seat Height: <b>420mm (16.5")</b>            Arm Height: <b>570mm (22.5")</b></p>																	

ROS/2 LOUNGE SOFA	Code:	Description	COM	1	2	3	4	5	6	7	8	9	10	COL	L1	L2	L3	(ly) (ft²) (lb)	LOUNGE SEATING
	ROS/2	Two-Seat Sofa with painted tubular steel frame	2654	2762	2892	2978	3130	3238	3432	3648	3928	4186	-	-	-	-	4.30	77	
	<p><b>DIMENSIONS</b>            Height: <b>785mm (31")</b>            Width: <b>1440mm (56.75")</b>            Depth: <b>810mm (32")</b>            Seat Height: <b>420mm (16.5")</b>            Arm Height: <b>570mm (22.5")</b></p>																		

Fabric Linear Metres Product Volume Inc. Packaging Product Weight

### Painted Frames

Color Choice	RAL 9005	RAL 9016	RAL 060 60 05	RAL 240 20 22	RAL 220 70 10	RAL 130 30 20	RAL 040 50 50	RAL 070 70 80
Suffix*	PF/B	PF/W	PF/SG	PF/DB	PF/LB	PF/GN	PF/CR	PF/Y
+\$	inc	inc	inc	inc	inc	inc	inc	inc

# Saint

Chairs & Stools Collection

boss



Design, detail and diversity... Saint®, our latest monoshell chair collection brings style and fun to any environment.

This beautifully contoured multi-purpose chair is the perfect example of the versatility offered by Boss Design.

Available in eight vibrant seat shell colors, with five base options with an optional upholstered seat pad, the specification choices are endless.



CHAIRS & STOOLS



## Range Information

- Flexible polypropylene shell
- SAI/1 & SAI/2 stacks up to 6 high
- Available in 8 RAL colors
- Custom RAL colors are also available based on a MOQ of 20 pieces of seat and frames. (Extended Lead time applies)



SAI/1 FOUR LEG FRAME	Code:	Description	\$	(lb)
 <p><b>DIMENSIONS</b>            Height: <b>830mm (33")</b>            Width: <b>585mm (23")</b>            Depth: <b>555mm (22")</b>            Seat Height: <b>435mm (17")</b>            Seat Depth: <b>465mm (18.5")</b>            Arm Height: <b>655mm (25.75")</b></p>	SAI/1/PF	Plastic Shell, non arm, painted frame	390	
	SAI/1/C	Plastic shell, non arm polished frame	418	
	SAI/1/PF/A	Plastic Shell, painted loop arm, painted frame	516	
	SAI/1/C/A	Plastic shell, polished loop arm polished frame	482	

SAI/2 SKID FRAME	Code:	Description	\$	(lb)
 <p><b>DIMENSIONS</b>            Height: <b>830mm (33")</b>            Width: <b>580mm (22.75")</b>            Depth: <b>555mm (22")</b>            Seat Height: <b>435mm (17")</b>            Seat Depth: <b>465mm (18.5")</b>            Arm Height: <b>655mm (25.75")</b></p>	SAI/2/PF	Plastic shell, non-arm, painted frame	424	
	SAI/2/C	Plastic shell, non-arm, polished frame	454	
	SAI/2/PF/A	Plastic shell, short black arm, painted frame	592	
	SAI/2/C/A	Plastic shell, short black arm , polished frame	562	

CHAIRS & STOOLS

**Painted Frame Options**

 Fabric Linear Yard  Leather Square Footage  Product Weight

Color Choice	RAL 9005	RAL 9016	RAL 060 60 05	RAL 240 20 22	RAL 220 70 10	RAL 130 30 20	RAL 040 50 50	RAL 070 70 80
Suffix*	PF/B	PF/W	PF/SG	PF/DB	PF/LB	PF/GN	PF/CR	PF/Y
+\$	inc	inc	inc	inc	inc	inc	inc	inc

**Options**

CODE:	DESCRIPTION	COM /1	2	3	4	5	6	7	8	9	10	COL	L1	L2	L3	(ft <sup>2</sup> )	(lb)
US	Upholstered Seat pad	112	126	142	152	170	184	208	234	268	298	128	268	354	614	0.50	9
Linking	Linking clips (only available on SAI/2)	POA	-	-	-	-	-	-	-	-	-	-	-	-	-	-	-
Stacking	Stacking Trolley - Stacks up to 12 high	1300	-	-	-	-	-	-	-	-	-	-	-	-	-	-	-

**SAI/4\***  
HIGH FOUR STAR FIXED HEIGHT BASE



**DIMENSIONS**

Height: **830mm (33")**  
 Width: **mm (" )**  
 Depth: **mm (" )**  
 Seat Height: **435mm (17")**  
 Seat Depth: **465mm (18.5")**  
 Arm Height: **655mm (25.75")**

Code:

Description

\$

(lb)

**SAI/4/PF**

Plastic shell, non-arm, painted base

838

**SAI/4/C**

Plastic shell, non-arm, polished aluminum

584

**SAI/4/HAT\*\***  
4 STAR HEIGHT ADJUSTABLE BASE WITH  
TILT MECHANISM



**DIMENSIONS**

Height: **810-930mm (32-36.5")**  
 Width: **545mm (21.5")**  
 Depth: **560mm (22")**  
 Seat Height: **420-540mm (16.5-21")**  
 Seat Depth: **465mm (18.5")**  
 Arm Height: **655mm (25.75")**

Code:

Description

\$

(lb)

**SAI/4/HAT/BL**

Plastic shell, non-arm, black base on black castors

594

**SAI/4/HAT/P**

Plastic shell, non-arm, polished aluminum base on black castors

620

Fabric Linear Yard Leather Square Footage Product Weight

**Options - SAI/4 & SAI/4/HAT**

CODE:	DESCRIPTION	COM /1	2	3	4	5	6	7	8	9	10	COL	L1	L2	L3	(ft²)	(lb)
US	Upholstered Seat pad	112	126	142	152	170	184	208	234	268	298	128	268	354	614	0.50	9
CA	Chrome Loop Arm	188	-	-	-	-	-	-	-	-	-	-	-	-	-	-	-
COL/A	Painted Loop Arm - 8 Boss colors	152	-	-	-	-	-	-	-	-	-	-	-	-	-	-	-
TM/B*	SAI/4 Only - Tilt Mechanism - Black	74	-	-	-	-	-	-	-	-	-	-	-	-	-	-	-
TM/P*	SAI/4 Only - Tilt Mechanism - Polished	98	-	-	-	-	-	-	-	-	-	-	-	-	-	-	-
SC**	SAI/4/HAT Only - Silver Castors	84	-	-	-	-	-	-	-	-	-	-	-	-	-	-	-

**SAI/4/HA**  
**LOW FOUR STAR WITH HEIGHT**  
**ADJUSTABLE BASE**



**DIMENSIONS**

Height: **810-930mm (32-36.5")**  
 Width: **545mm (21.5")**  
 Depth: **560mm (22")**  
 Seat Height: **420-540mm (16.5-21")**  
 Seat Depth: **465mm (18.5")**

**Code:**

**Description**

**\$**



**SAI/4/HA/BL**

Plastic shell, non-arm, black base on black castors

594

**SAI/4/HA/P**

Plastic shell, non-arm, polished aluminum base on black castors

620

**Options - SAI/4 & SAI/4/HAT**

CODE:	DESCRIPTION	COM / O	2	3	4	5	6	7	8	9	10	COL	L1	L2	L3		
US	Upholstered Seat pad	112	126	142	152	170	184	208	234	268	298	128	268	354	614	0.50	9
SC**	Silver Castors	84	-	-	-	-	-	-	-	-	-	-	-	-	-	-	-

**Painted Base Options - SAI/4/HAT & SAI/4/HA**

Other colors are available POA and to a minimum order quantity

<b>Color Choice</b>	<b>RAL 9005</b>
<b>Suffix*</b>	<b>PF/B</b>
<b>\$</b>	<b>\$inc</b>

**SAI/5/HA/TM**  
5 STAR HEIGHT ADJUSTABLE BASE WITH  
TILT MECHANISM



**DIMENSIONS**

Height: **810-930mm (32-36.5")**  
Width: **545mm (21.5")**  
Depth: **560mm (22")**  
Seat Height: **345-465mm (13.5-18.5")**  
Seat Depth: **465mm (18.5")**  
Arm Height: **665mm (26.25")**

Code:

Description

\$



SAI/5/HA/TM-B

Plastic shell, non-arm, black base, castors and black tilt mechanism

608

SAI/5/HA/TM-P

Plastic shell, non-arm, polished base, black castors and polished tilt mechanism

622

**SAI/5/HA\***  
5 STAR WITH HEIGHT ADJUSTABLE BASE



**DIMENSIONS**

Height: **745-865mm (29.5-34")**  
Width: **645mm (25.25")**  
Depth: **625mm (24.75")**  
Seat Height: **355-475mm (14-19")**  
Seat Depth: **465mm (18.5")**  
Tablet Height: **655-775mm (25.75-30.75")**

Code:

Description

\$



SAI/5/HA/BL

Plastic shell, non-arm, black base on black castors

596

SAI/5/HA/P

Plastic shell, non-arm, polished aluminum base on black castors

606

**Painted Frame Options**

Fabric Linear Yard Leather Square Footage Product Weight

Color Choice	RAL 9005
Suffix*	PF/B
\$	\$inc

**Options**

CODE:	DESCRIPTION	COM /1	2	3	4	5	6	7	8	9	10	COL	L1	L2	L3		
US	Upholstered Seat pad	126	142	152	170	184	208	234	268	298	128	268	354	614	0	0.50	9
CA	Chrome Loop Arm	188	-	-	-	-	-	-	-	-	-	-	-	-	-	-	-
COL/A	Painted Loop Arm - 8 Boss colors	138	-	-	-	-	-	-	-	-	-	-	-	-	-	-	-
*WT	Saint Writing Tablet on swivel arm	450	-	-	-	-	-	-	-	-	-	-	-	-	-	-	-
SC	Silver Castors	84	-	-	-	-	-	-	-	-	-	-	-	-	-	-	-

**SAI/7  
SKID FRAME BARSTOOL**

**Code:**

**Description**

**\$**

 **(lb)**



**SAI/7/PF**

Plastic shell, non-arm, painted frame

600

**SAI/7/C**

Plastic shell, non-arm, polished frame

624

**DIMENSIONS**



Height: **1155mm (45.5")**  
 Width: **595mm (23.5")**  
 Depth: **560mm (22")**  
 Seat Height: **750mm (29.5")**  
 Seat Width: **470mm (18.5")**

 Fabric Linear Yard  Leather Square Footage  Product Weight

**Painted Frame Options**

Color Choice	RAL 9005	RAL 9016	RAL 060 60 05	RAL 240 20 22	RAL 220 70 10	RAL 130 30 20	RAL 040 50 50	RAL 070 70 80
Suffix*	PF/B	PF/W	PF/SG	PF/DB	PF/LB	PF/GN	PF/CR	PF/Y
+\$	inc	inc	inc	inc	inc	inc	inc	inc

**Options**

CODE:	DESCRIPTION	COM /1	2	3	4	5	6	7	8	9	10	COL	L1	L2	L3	 (ft²)	 (lb)
US	Upholstered Seat pad	112	126	142	152	170	184	208	234	268	298	128	268	354	614	0.50	9

**Shell Options**



**Black**  
RAL 9005



**White**  
RAL 9016



**Light Grey**  
RAL 060 60 05



**Dark Blue**  
RAL 240 20 22



**Light Blue**  
RAL 220 70 10



**Green**  
RAL 130 30 20



**Coral**  
RAL 040 50 50



**Yellow**  
RAL 070 70 80

# Tokyo

Chairs

boss





The smooth, organic curves and sprung frame of Tokyo guarantees a relaxed sitting experience. The soft padding adds extra comfort, while its fine seam patterned upholstery and striking sleek chrome arms demonstrate the hallmarks of Boss Design.



CHAIRS



## Range Information

- CMHR seat and back foams
- Sprung seat for comfort
- Upholstered in any fabric or leather
- Not recommended to be upholstered in Grade 1 fabrics



**TOK/1  
MEETING CHAIR**

**Code:**

**Description**

**COM  
/1**

2

3

4

5

6

7

8

9

10

COL

L1

L2

L3

(ly)

(ft<sup>2</sup>)

(lb)



**TOK/1**

Fully upholstered  
Non-arm 4 star base

1844

1908

1984

2034

2122

2186

2300

2426

2590

2740

1928

2626

3054

4358

2.50

45

**DIMENSIONS**

Height: **825mm (32.5")**  
 Width: **545mm (21.5")**  
 Depth: **600mm (23.75")**  
 Seat Height: **480mm (19")**  
 Seat Depth: **460mm (18")**

N.B. Leather is a natural material which will crease and 'puddle'.

Fabric Linear Yard Leather Square Footage Product Weight

**Options**

CODE:	DESCRIPTION	\$
<b>P5</b>	5 star polished swivel base on castors	56
<b>CA</b>	Chrome arms	404
<b>QUILTED</b>	Horizontal quilted stitch finish - seat & back	366

**Painted Frame Options**

Color Choice	RAL 9005	RAL 9016	RAL 060 60 05	RAL 240 20 22	RAL 220 70 10	RAL 130 30 20	RAL 040 50 50	RAL 070 70 80
Suffix*	PF/B	PF/W	PF/SG	PF/DB	PF/LB	PF/GN	PF/CR	PF/Y
\$	160	160	160	160	160	160	160	130

CHAIRS



# Toto

Chairs

# boss



Combining style and versatility Toto is a family of multi-purpose chairs. Ideal for the demands of the modern workplace, the range is suitable for meeting rooms, breakout areas, dining areas and hospitality environments.

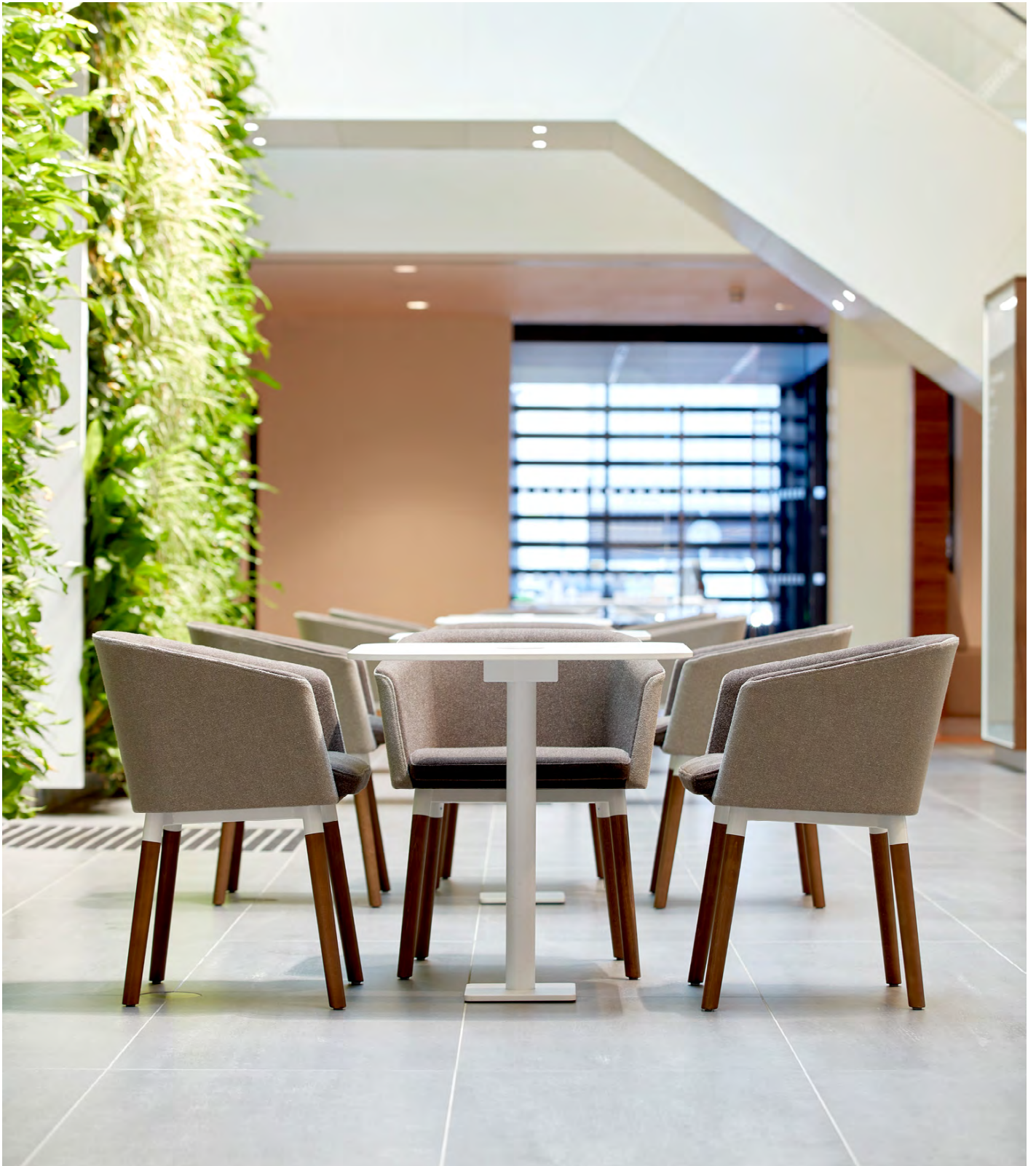

CHAIRS



## Range Information

- Range consists of a polished aluminum 4 star swivel base, 4 leg chrome steel frame, 4 leg oak chair with white chassis frame and 5 star base with tilt mechanism
- High and low back chair
- Moulded with CMHR foam
- Features a multi-layered dual density seat for optimum sitting comfort



**TOT/1**  
**4 LEG CHROME FRAME**

Code:

Description

COM /1

2

3

4

5

6

7

8

9

10

COL

L1

L2

L3



**TOT/1/LB**

Toto low back,  
4-leg chrome  
frame

1166 1204 1250 1280 1334 1372 1440 1516 1614 1704 1218 1638 1894 2676

1.50 27

**DIMENSIONS**

Height: **735mm (29")**  
Width: **620mm (24.25")**  
Depth: **550mm (21.5")**  
Seat Height: **465mm (18.25")**  
Arm Height: **645mm (25.25")**



**TOT/1/HB**

Toto high back,  
4-leg chrome  
frame

1160 1204 1258 1294 1356 1400 1480 1568 1682 1788 1218 1714 2018 2946

1.75 32

**DIMENSIONS**

Height: **805mm (31.75")**  
Width: **600mm (23.5")**  
Depth: **595mm (23.5")**  
Seat Height: **465mm (18.25")**  
Arm Height: **645mm (25.25")**

**Painted Frame Options**

Color Choice	RAL 9005	RAL 9016	RAL 060 60 05	RAL 240 20 22	RAL 220 70 10	RAL 130 30 20	RAL 040 50 50	RAL 070 70 80
Suffix*	PF/B	PF/W	PF/SG	PF/DB	PF/LB	PF/GN	PF/CR	PF/Y
\$	100	100	100	100	100	100	100	100

CHAIRS

**TOT/3/OAK/...**  
**4 LEG TIMBER LEGS**

Code:

Description

COM /1

2

3

4

5

6

7

8

9

10

COL

L1

L2

L3



**TOT/3/LB**

Toto low back,  
4-leg oak,  
white chassis

1502 1540 1586 1616 1670 1708 1776 1852 1950 2040 1556 1976 2232 3014

1.50 27

**DIMENSIONS**

Height: **745mm (29.5")**  
Width: **620mm (24.25")**  
Depth: **550mm (21.5")**  
Seat Height: **465mm (18.25")**



**TOT/3/HB**

Toto high back  
4-leg oak,  
white chassis

1482 1526 1580 1616 1678 1722 1802 1890 2004 2110 1542 2038 2342 3270

1.75 32

**DIMENSIONS**

Height: **820mm (32.25")**  
Width: **600mm (23.5")**  
Depth: **585mm (23")**  
Seat Height: **465mm (18.25")**

**TOT/4**  
**4 STAR BASE**

**Code:**      **Description**      **COM**    **2**    **3**    **4**    **5**    **6**    **7**    **8**    **9**    **10**    **COL**    **L1**    **L2**    **L3**



**TOT/4/LB**

Toto low back,  
polished 4-star  
base

1478 1516 1562 1592 1646 1684 1752 1828 1926 2016 1532 1952 2208 2990

1.50 27

**DIMENSIONS**

Height: **750mm (29.5")**  
Width: **620mm (24.25")**  
Depth: **550mm (21.5")**  
Seat Height: **465mm (18.25")**  
Arm Height: **670mm (26.5")**



**TOT/4/HB**

Toto high back  
chair, polished  
4-star base

1462 1506 1560 1596 1658 1702 1782 1870 1984 2090 1522 2018 2322 3250

1.75 32

**DIMENSIONS**

Height: **820mm(32.25")**  
Width: **600mm (23.5")**  
Depth: **575mm (22.5")**  
Seat Height: **465mm (18.25")**  
Arm Height: **590mm (23.25")**

**Painted Frame Options**

Color Choice	RAL 9005	RAL 9016	RAL 060 60 05	RAL 240 20 22	RAL 220 70 10	RAL 130 30 20	RAL 040 50 50	RAL 070 70 80
Suffix*	PF/B	PF/W	PF/SG	PF/DB	PF/LB	PF/GN	PF/CR	PF/Y
\$	160	160	160	160	160	160	160	160

**TOT/5**  
**5 STAR POLISHED BASE**

**Code:**      **Description**      **COM**    **2**    **3**    **4**    **5**    **6**    **7**    **8**    **9**    **10**    **COL**    **L1**    **L2**    **L3**



**TOT/5/LB**

Toto low back,  
polished 5-star  
base

1434 1472 1518 1548 1602 1640 1708 1784 1882 1972 1488 1908 2164 2946

1.50 27

**DIMENSIONS**

Height: **695mm-815mm (27"-32")**  
Width: **700mm (27.5")**  
Depth: **675mm (26.75")**  
Seat Height: **420mm-540mm (16.25"-21.25")**



**TOT/5/HB**

Toto high back,  
polished 5-star  
base

1432 1476 1530 1566 1628 1672 1752 1840 1954 2060 1492 1988 2292 3220

1.75 32

**DIMENSIONS**

Height: **770mm-890mm (30.25"-35")**  
Width: **700mm (27.5")**  
Depth: **675mm (26.75")**  
Seat Height: **420mm-540mm (16.25"-21.25")**

TOT/PLUS... TOTO PLUS HIGH BACK	Code:	Description	COM	2	3	4	5	6	7	8	9	10	COL	L1	L2	L3			
				/1													(ly)	(ft²)	(lb)
	TOT/PLUS/4	4 star base, High back, fully upholstered	1634	1684	1744	1784	1854	1904	1994	2094	2224	2344	1702	2260	2602	3646	2.00	36	
	<b>DIMENSIONS</b> Height: 820mm(32.25") Width: 650mm (25.5") Depth: 575mm (22.5") Seat Height: 465mm (18.25") Arm Height: 590mm (23.25")																		

**Painted Frame Options**

Color Choice	RAL 9005	RAL 9016	RAL 060 60 05	RAL 240 20 22	RAL 220 70 10	RAL 130 30 20	RAL 040 50 50	RAL 070 70 80
Suffix*	PF/B	PF/W	PF/SG	PF/DB	PF/LB	PF/GN	PF/CR	PF/Y
\$	160	160	160	160	160	160	160	160

TOT/PLUS/5 TOTO PLUS HIGH BACK WITH 5 STAR BASE	Code:	Description	COM	2	3	4	5	6	7	8	9	10	COL	L1	L2	L3			
				/1													(ly)	(ft²)	(lb)
	TOT/PLUS/5	5 star base, High back, fully upholstered	1592	1642	1702	1742	1812	1862	1952	2052	2182	2302	1660	2218	2560	3604	2.00	36	
	<b>DIMENSIONS</b> Height: 770mm-890mm (30.25"-35") Width: 650mm (25.5") Depth: 575mm (22.5") Seat Height: 465mm (18.25") Arm Height: 590mm (23.25")																		

**Painted Frame Options**

Color Choice	RAL 9005
Suffix*	PF/B
\$	160

CHAIRS



03.

# Modular Seating

# Arthur CityScape

boss

## Modular Seating Collection

### High & Low Back Seating

Arthur is available in both high back and low back configurations that feature a hardwood and plywood internal frame.

Seat Cushion:  
CMHR foam and Fibre

Lumbar cushion:  
Foam and Feather

Back:  
CMHR Fixed Foam back



### Bumped Back Seating

Arthur Cityscape Bumped Back seating is constructed using the same materials as detailed above, however features a bumped detail

Please note: Bumped back is only available on high back units.



### Arthur Configurations

Arthur CityScape is available in a wide variety of configurations in high back, low back or a mix of both heights.

A full suite of 3D files are available for you to download from our website [bossdesign.com](http://bossdesign.com)

Where a corner configuration is created, a designated corner unit must be specified (i.e. ARC/7, ARC/17, ARC/18, ARC/27, ARC/28)



### Power & Data

Arthur CityScape is configurable with a Phase power unit which is located and mounted to the underneath of the underframe



Phase - 1x Power, 1x TUF A&C

**Specification**

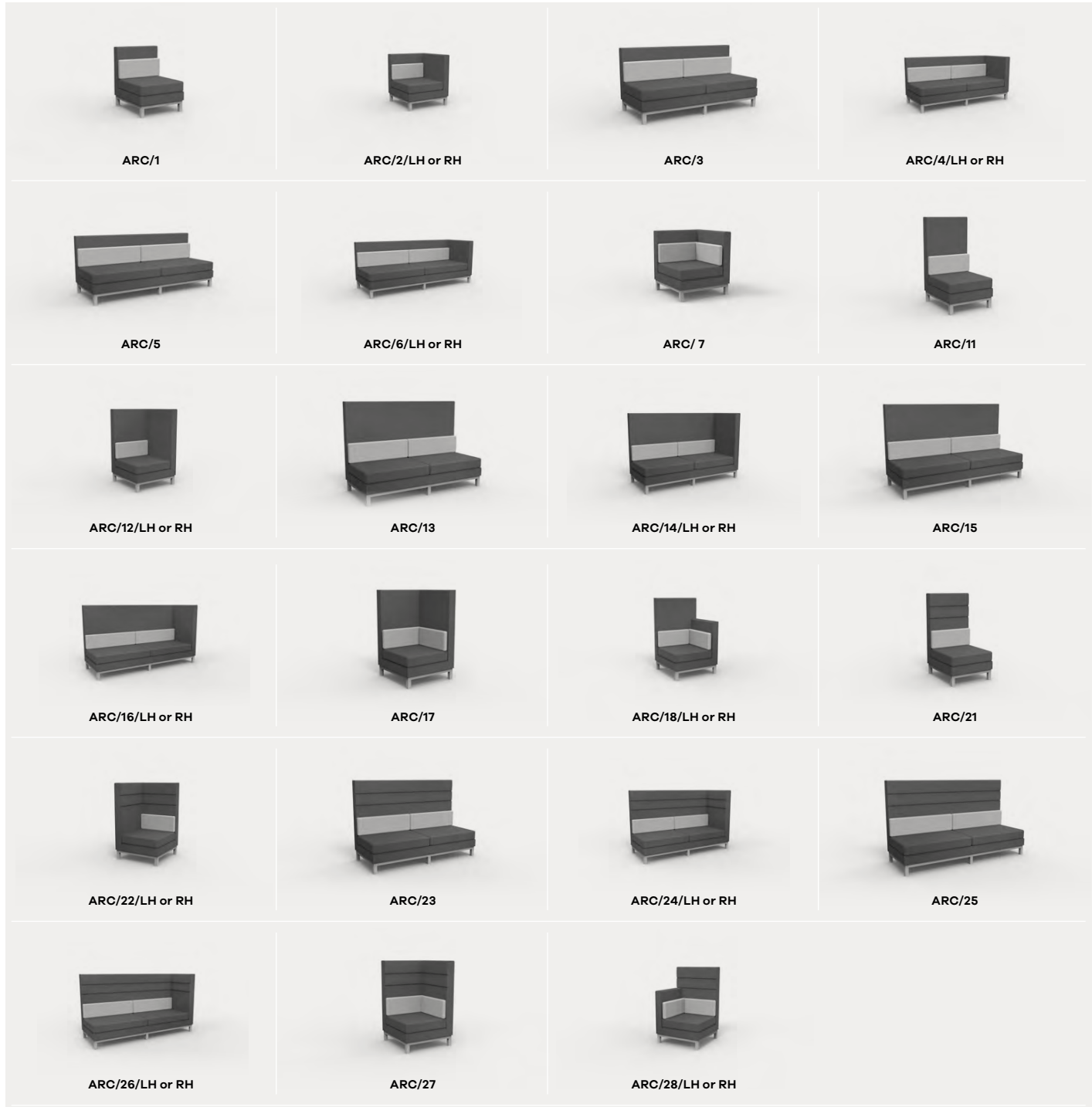

MODULAR SEATING SYSTEMS

**Arthur Cityscape Configurations**

To aid you in creating your space, we have a full range of 3D files available, which you can access by scanning, or clicking on, the QR Code shown below.

Alternatively you can visit our website [bossdesign.com](http://bossdesign.com)

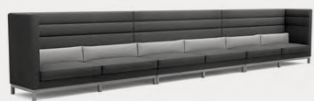

ARC/Config 1



ARC/Config 2



ARC/Config 3



ARC/Config 4



ARC/Config 5



ARC/Config 6

# Arthur CityScape

Modular Seating Collection





boss











## Range Information

- Hardwood and plywood internal frame
- CMHR foam and fibre seat cushion
- Foam and feather lumbar cushion
- CMHR fixed foam back
- Timber: Beech
- Top stitch detail
- Additional charge for timber underframe in Oak, American Black Walnut or to a painted finish (painted finish is \$178).
- Where a corner configuration is created, a designated corner unit must be specified (i.e. ARC/7, ARC/17, ARC/18, ARC/27, ARC/28)
- Where units are to be linked (and linking mechanisms required), a plan drawing must be submitted to confirm the layout required
- Not recommended to be upholstered in Grade 1 fabrics

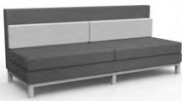

<b>LOW BACK, ONE SEAT</b>	<b>Code:</b>	<b>Description</b>	<b>COM /1</b>	<b>2</b>	<b>3</b>	<b>4</b>	<b>5</b>	<b>6</b>	<b>7</b>	<b>8</b>	<b>9</b>	<b>10</b>	 <b>(ly)</b>	 <b>(lb)</b>
	<b>ARC/1</b>	Arthur CityScape Low-back one seat armless	2658	2834	3044	3184	3430	3606	3922	4272	4728	5148	7.00	
	<b>ARC/2/LH</b>	Arthur CityScape Low-back one seat single arm, Left Hand sitting	2926	3126	3366	3526	3806	4006	4366	4766	5286	5766	8.00	
	<b>ARC/2/RH</b>	Arthur CityScape Low-back one seat single arm, Right Hand sitting	2926	3126	3366	3526	3806	4006	4366	4766	5286	5766	8.00	

<b>LOW BACK, COMPACT SOFA</b>	<b>Code:</b>	<b>Description</b>	<b>COM /1</b>	<b>2</b>	<b>3</b>	<b>4</b>	<b>5</b>	<b>6</b>	<b>7</b>	<b>8</b>	<b>9</b>	<b>10</b>	 <b>(ly)</b>	 <b>(lb)</b>
	<b>ARC/3</b>	Arthur CityScape Low-back compact sofa armless	4494	4794	5154	5394	5814	6114	6654	7254	8034	8754	12.00	
	<b>ARC/4/LH</b>	Arthur CityScape Low-back compact sofa single arm, Left Hand sitting	5026	5352	5742	6002	6458	6784	7370	8020	8866	9646	13.00	
	<b>ARC/4/RH</b>	Arthur CityScape Low-back compact sofa single arm, Right Hand sitting	5026	5352	5742	6002	6458	6784	7370	8020	8866	9646	13.00	



<b>LOW BACK, LARGE SOFA</b>	<b>Code:</b>	<b>Description</b>	<b>COM /1</b>	<b>2</b>	<b>3</b>	<b>4</b>	<b>5</b>	<b>6</b>	<b>7</b>	<b>8</b>	<b>9</b>	<b>10</b>	 <b>(ly)</b>	 <b>(lb)</b>
	<b>ARC/5</b>	Arthur CityScape Low-back large sofa armless	4856	5156	5516	5756	6176	6476	7016	7616	8396	9116	12.00	
	<b>ARC/6/LH</b>	Arthur CityScape Low-back large sofa single arm, Left Hand sitting	5372	5698	6088	6348	6804	7130	7716	8366	9212	9992	13.00	
	<b>ARC/6/RH</b>	Arthur CityScape Low-back large sofa single arm, Right Hand sitting	5372	5698	6088	6348	6804	7130	7716	8366	9212	9992	13.00	

MODULAR SEATING SYSTEMS



**LOW BACK  
CORNER UNIT**

	Code:	Description	COM /1	2	3	4	5	6	7	8	9	10	(ly)	(lb)
	<b>ARC/7</b>	Arthur CityScape Low-back corner unit	3128	3304	3514	3654	3900	4076	4392	4742	5198	5618	7.00	

**HIGH BACK  
ONE SEAT**

	Code:	Description	COM /1	2	3	4	5	6	7	8	9	10	(ly)	(lb)
	<b>ARC/11</b>	Arthur CityScape High-back one seat armless	3016	3242	3512	3692	4008	4234	4640	5090	5676	6216	9.00	
	<b>ARC/12/LH</b>	Arthur CityScape High-back one seat single arm, Left Hand sitting	3468	3718	4018	4218	4568	4818	5268	5768	6418	7018	10.00	
	<b>ARC/12/RH</b>	Arthur CityScape High-back one seat single arm, Right Hand sitting	3468	3718	4018	4218	4568	4818	5268	5768	6418	7018	10.00	

**HIGH BACK  
COMPACT SOFA**

	Code:	Description	COM /1	2	3	4	5	6	7	8	9	10	(ly)	(lb)
	<b>ARC/13</b>	Arthur CityScape High-back compact sofa armless	5098	5448	5868	6148	6638	6988	7618	8318	9228	10068	14.00	
	<b>ARC/14/LH</b>	Arthur CityScape High-back compact sofa single arm, Left Hand sitting	5322	5722	6202	6522	7082	7482	8202	9002	10042	11002	16.00	
	<b>ARC/14/RH</b>	Arthur CityScape High-back compact sofa single arm, Right Hand sitting	5322	5722	6202	6522	7082	7482	8202	9002	10042	11002	16.00	



HIGH BACK LARGE SOFA	Code:	Description	COM	2	3	4	5	6	7	8	9	10	(ly)	(lb)
			/1											
	ARC/15	Arthur CityScape High-back large sofa armless	5520	5870	6290	6570	7060	7410	8040	8740	9650	10490	14.00	
	ARC/16/LH	Arthur CityScape High-back large sofa single arm, Left Hand sitting	5808	6208	6688	7008	7568	7968	8688	9488	10528	11488	16.00	
	ARC/16/RH	Arthur CityScape High-back large sofa single arm, Right Hand sitting	5808	6208	6688	7008	7568	7968	8688	9488	10528	11488	16.00	

HIGH BACK CORNER UNIT	Code:	Description	COM	2	3	4	5	6	7	8	9	10	(ly)	(lb)
			/1											
	ARC/17	Arthur CityScape High-back corner unit	3654	3880	4150	4330	4646	4872	5278	5728	6314	6854	9.00	
	ARC/18/LH	Arthur CityScape dual height corner unit, Left Hand sitting	3760	3986	4256	4436	4752	4978	5384	5834	6420	6960	9.00	
	ARC/18/RH	Arthur CityScape dual height corner unit, Right Hand sitting	3760	3986	4256	4436	4752	4978	5384	5834	6420	6960	9.00	



HIGH BACK, ONE SEAT BUMPED BACK	Code:	Description	COM	2	3	4	5	6	7	8	9	10	(ly)	(lb)
			/1											
	ARC/21	Arthur CityScape High-back one seat armless, bumped back	3040	3266	3536	3716	4032	4258	4664	5114	5700	6240	9.00	
	ARC/22/LH	Arthur CityScape High-back one seat single arm, Left Hand sitting, bumped back	3690	3940	4240	4440	4790	5040	5490	5990	6640	7240	10.00	
	ARC/22/RH	Arthur CityScape High-back one seat single arm, Right Hand sitting, bumped back	3690	3940	4240	4440	4790	5040	5490	5990	6640	7240	10.00	

MODULAR SEATING SYSTEMS



**HIGH BACK, COMPACT SOFA, BUMPED BACK**

	Code:	Description	COM /1	2	3	4	5	6	7	8	9	10	(ly)	(lb)
	<b>ARC/23</b>	Arthur CityScape High-back compact sofa armless, bumped back	5322	5672	6092	6372	6862	7212	7842	8542	9452	10292	14.00	
	<b>ARC/24/LH</b>	Arthur CityScape High-back compact sofa single arm, Left Hand sitting, bumped back	5746	6146	6626	6946	7506	7906	8626	9426	10466	11426	16.00	
	<b>ARC/24/RH</b>	Arthur CityScape High-back compact sofa single arm, Right Hand sitting, bumped back	5746	6146	6626	6946	7506	7906	8626	9426	10466	11426	16.00	

**HIGH BACK, LARGE SOFA, BUMPED BACK**

	Code:	Description	COM /1	2	3	4	5	6	7	8	9	10	(ly)	(lb)
	<b>ARC/25</b>	Arthur CityScape High-back large sofa armless, bumped back	5794	6144	6564	6844	7334	7684	8314	9014	9924	10764	14.00	
	<b>ARC/26/LH</b>	Arthur CityScape High-back large sofa single arm, Left Hand sitting, bumped back	6156	6556	7036	7356	7916	8316	9036	9836	10876	11836	16.00	
	<b>ARC/26/RH</b>	Arthur CityScape High-back large sofa single arm, Right Hand sitting, bumped back	6156	6556	7036	7356	7916	8316	9036	9836	10876	11836	16.00	

**HIGH BACK, CORNER UNIT, BUMPED BACK**

	Code:	Description	COM /1	2	3	4	5	6	7	8	9	10	(ly)	(lb)
	<b>ARC/27</b>	Arthur CityScape High-back corner unit, bumped back	5794	6020	6290	6470	6786	7012	7418	7868	8454	8994	9.00	
	<b>ARC/28/LH</b>	Arthur CityScape dual height corner unit, Left Hand sitting, bumped back	6156	6382	6652	6832	7148	7374	7780	8230	8816	9356	9.00	
	<b>ARC/28/RH</b>	Arthur CityScape dual height corner unit, Right Hand sitting, bumped back	6156	6382	6652	6832	7148	7374	7780	8230	8816	9356	9.00	



Dual height configurations can be created using High Back and Low Back units (linked by Dual Height Corner units)

**Options**

CODE:	DESCRIPTION	\$
-	Oak underframe ARC 1/2/7/11/18/21/22/27/28	118
-	Oak underframe ARC 3/4/13/14/23/24/31	180
-	Oak underframe ARC 5/6/15/16/25/26/32	232
-	American Black Walnut underframe ARC 1/2/7/11/18/21/22/27/28	176

CODE:	DESCRIPTION	\$
-	American Black Walnut ARC 3/4/13/14/23/24/31	268
-	American Black Walnut ARC 5/6/15/16/25/26/32	326
-	Set of 2 linking mechanisms	110
-	Polished Aluminum leg set	118

6 - 8 person configuration

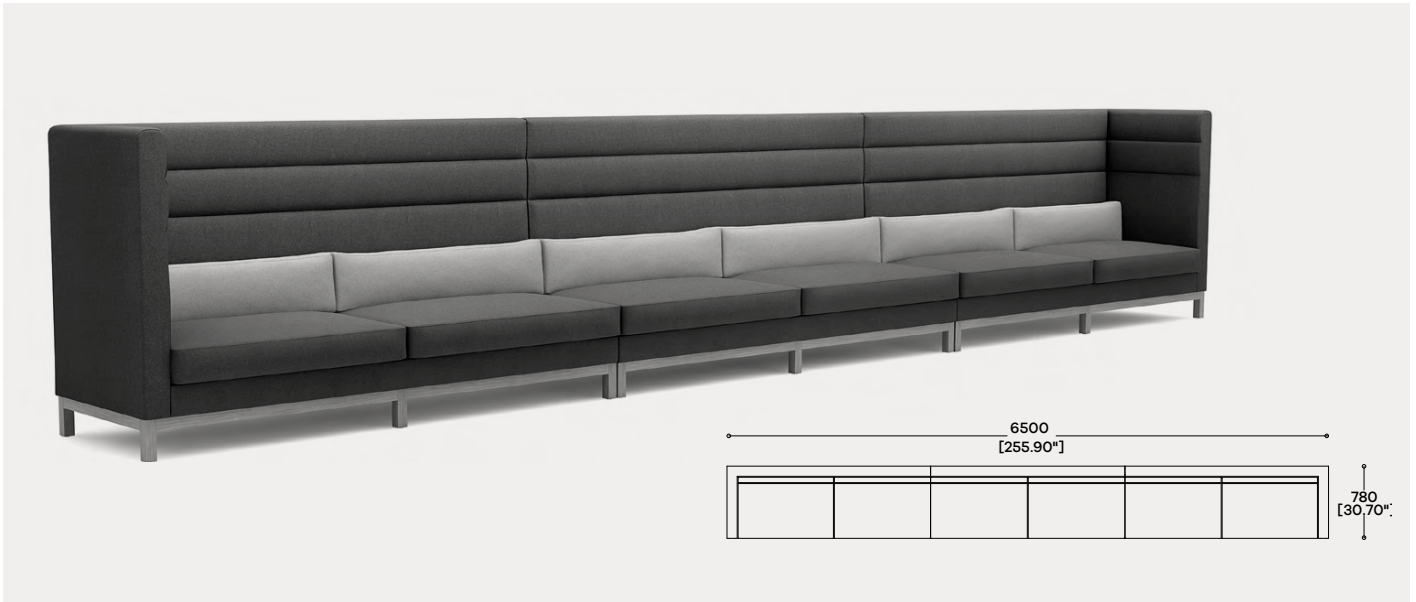

4 person configuration



4 person configuration



**6 - 7 person configuration**



**6 - 8 person configuration**



MODULAR SEATING SYSTEMS

**6 - 8 person configuration**



# Atom

Modular Seating Collection

boss



ATOM is a single unifying family of products comprised of seating, tables and desks. Developed to bring harmony to the workplace.

Unique in its adaptability, ATOM has been designed to respond to the way people interact with their working

environments. Extensive, adaptable and elegant – ATOM makes every space matter. The ATOM breakout collection is organic, sculptural and intuitive, creating collaborative space for interaction and bringing harmony to the workspace.



## Modular Seating Collection

### High Back Seating

All ATOM high back units are sized at H 51" (1300mm) and feature an integrated low profile headrest/cushion moulding into the backrest.

The total backrest height from the seat is 37.5" (955mm) across the units

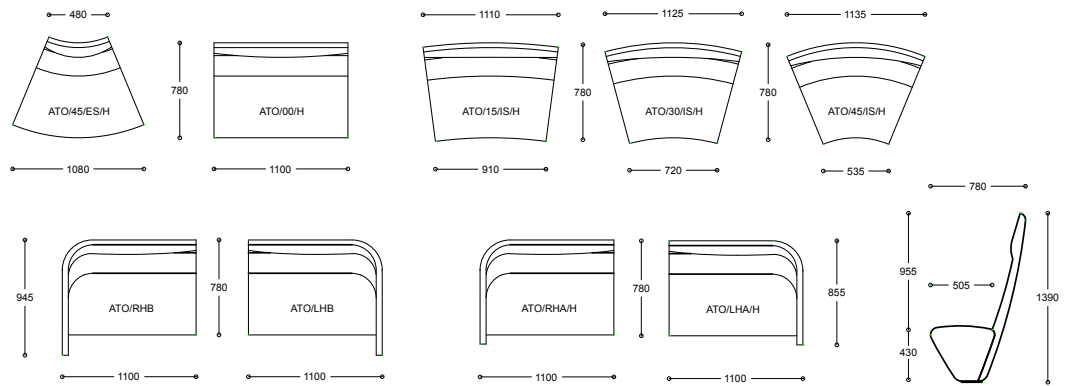

### Low Back Seating

All ATOM low back units are sized at H 39.75" (H1010mm) and feature a mid back backrest.

The total backrest height from the seat is 23" (580mm) across the units

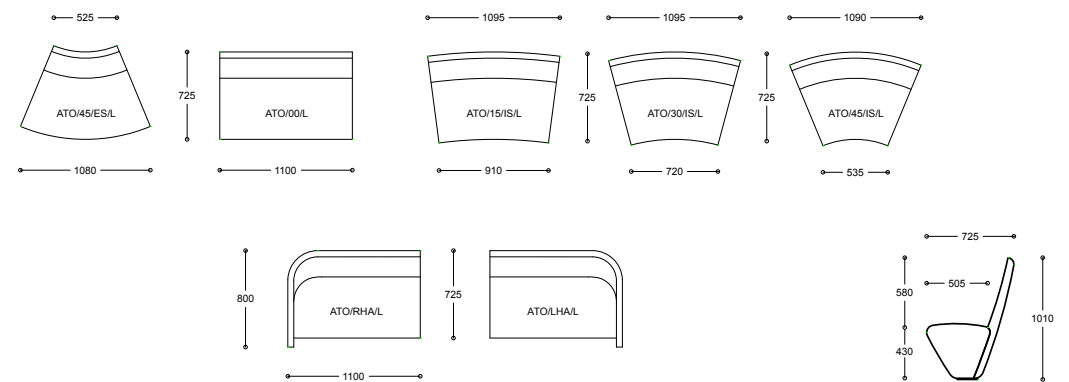

### Atom Booth with Table

ATOM is configurable in almost unlimited configurations, however we have supplied pricing for our most popular booth.

ATOM Meeting Booth: ATO/COB001

Table Top Material: MF MDF

Leg finish options: Available in polished, Black RAL9005 or White RAL9016.

Table thickness = 1" (25mm)

Chamfered Edge

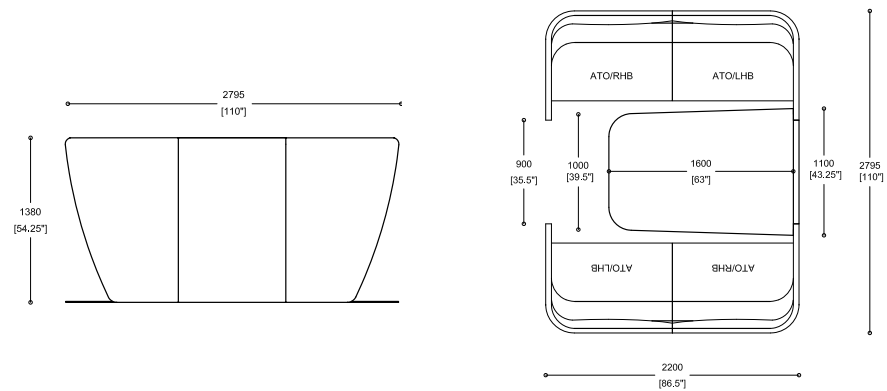

### Power & Data

Atom seating units can be specified with Pixel power units as standard with 1x power & TUF

The Atom Table and booth can be specified with any of the options shown (right) with the power located on the table top.

**Please Note:** When specifying the ATOM Meeting Booth (ATO/COB001) neither a bracket nor a TV is supplied



ARC-H LD  
Black or White



Pixel  
1x Power +TUF



Phase  
1x Power, 1x TUF

**ATOM Single Options**

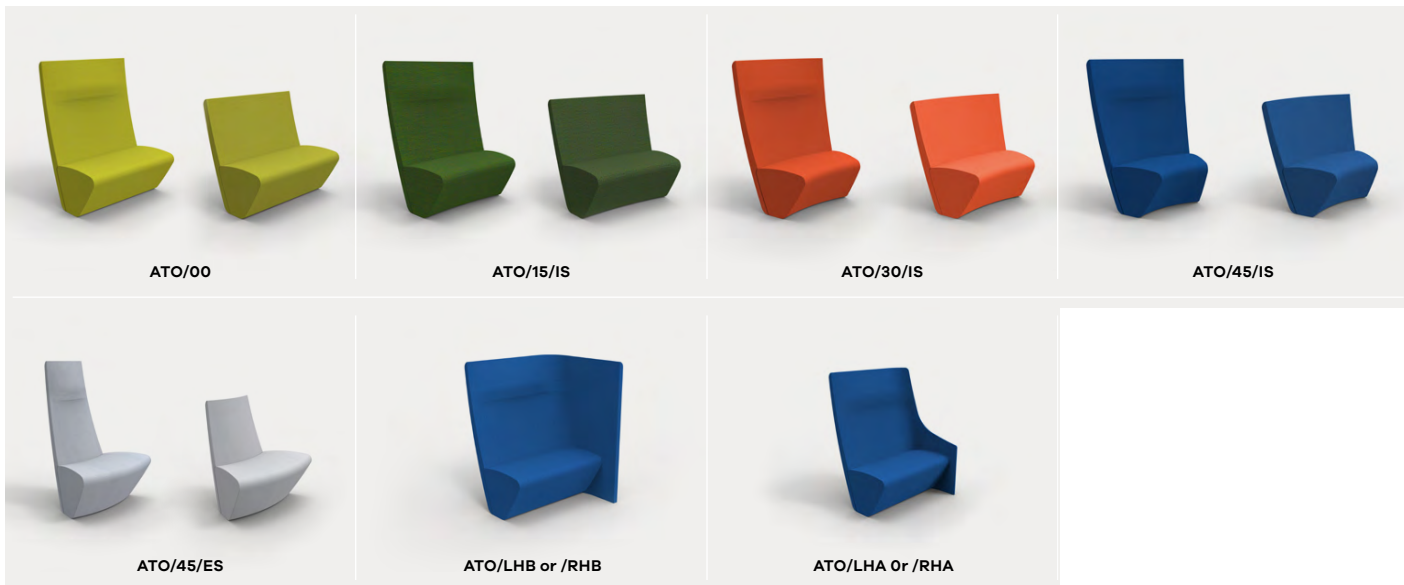

**ATOM Configuration Options**

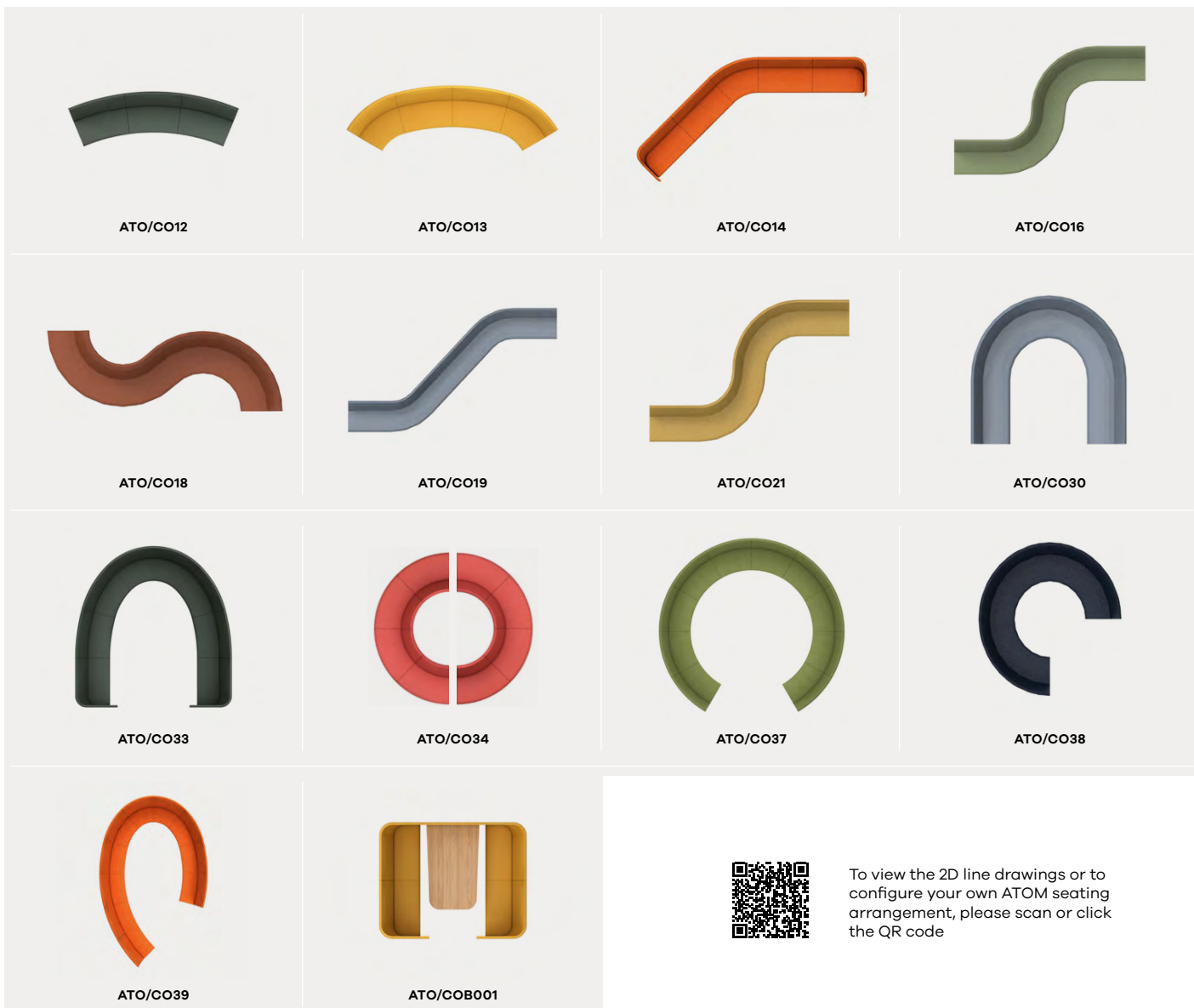

MODULAR SEATING SYSTEMS



To view the 2D line drawings or to configure your own ATOM seating arrangement, please scan or click the QR code



## Range Information

- Seating units are built around a 450mm (17.75") seat height (with compressed foam) to provide the user with an ergonomically-sound working posture that can be combined with standard 720 to 740mm (28.5" - 29.25") high tables and desks
- Every ATOM setting is available with power and data
- Rotationally-moulded polyethylene (MDPE) seats
- Moulded polyurethane (PU) backs with integral steel armatures
- 50kg/m<sup>3</sup> (3.1lb/ft<sup>3</sup>) foam density throughout
- ATOM can be upholstered in a broad array of fabrics
- Please visit [bossdesign.com](http://bossdesign.com) for more information and a full list of pre-configured settings or download our Revit blocks to create your own bespoke solutions.
- N.B Unit weights are different depending on where the individual item is situated within a configuration due to the use (or lack of use) of a steel end plate.





**ATO/...  
MODULAR SEATING SYSTEMS**

	Code:	Description	COM /1	2	3	4	5	6	7	8	9	10	(ly)	(lb)
	<b>ATO/00/H</b>	Straight Unit High Back	3476	-	3774	3882	4072	4208	4452	4722	5074	5398	5.40	<b>Centre End</b>
	<b>ATO/00/L</b>	Straight Unit Low Back	3280	-	3544	3640	3808	3928	4144	4384	4696	4984	4.80	<b>Centre End</b>
	<b>ATO/15/IS/H</b>	15° Internal Unit High Back	3476	-	3774	3882	4072	4208	4452	4722	5074	5398	5.40	<b>Centre End</b>
	<b>ATO/15/IS/L</b>	15° Internal Unit Low Back	3280	-	3544	3640	3808	3928	4144	4384	4696	4984	4.80	<b>Centre End</b>
	<b>ATO/30/IS/H</b>	30° Internal Unit High Back	3476	-	3774	3882	4072	4208	4452	4722	5074	5398	5.40	<b>Centre End</b>
	<b>ATO/30/IS/L</b>	30° Internal Unit Low Back	3280	-	3544	3640	3808	3928	4144	4384	4696	4984	4.80	<b>Centre End</b>
	<b>ATO/45/IS/H</b>	45° Internal Unit High Back	3476	-	3774	3882	4072	4208	4452	4722	5074	5398	5.40	<b>Centre End</b>
	<b>ATO/45/IS/L</b>	45° Internal Unit Low Back	3280	-	3544	3640	3808	3928	4144	4384	4696	4984	4.80	<b>Centre End</b>
	<b>ATO/45/ES/H</b>	45° External Unit High Back	3476	-	3774	3882	4072	4208	4452	4722	5074	5398	5.40	<b>Centre End</b>
	<b>ATO/45/ES/L</b>	45° External Unit Low Back	3280	-	3544	3640	3808	3928	4144	4384	4696	4984	4.80	<b>Centre End</b>
	<b>ATO/LHB/H</b>	End Unit Left Hand	4654	-	5168	5354	5680	5914	6334	6800	7406	7964	9.30	<b>Centre - End</b>
	<b>ATO/RHB/H</b>	End Unit Right Hand	4654	-	5168	5354	5680	5914	6334	6800	7406	7964	9.30	<b>Centre - End</b>
	<b>ATO/LHA/H</b>	End Arm Unit Left Hand High Back	4654	-	5168	5354	5680	5914	6334	6800	7406	7964	9.30	<b>Centre - End</b>
	<b>ATO/RHA/H</b>	End Arm Unit Right Hand High Back	4654	-	5168	5354	5680	5914	6334	6800	7406	7964	9.30	<b>Centre - End</b>
	<b>ATO/LHA/L</b>	End Arm Unit Left Hand Low Back	4394	-	4908	5094	5420	5654	6074	6540	7146	7704	9.30	<b>Centre - End</b>
	<b>ATO/RHA/L</b>	End Arm Unit Right Hand Low Back	4394	-	4908	5094	5420	5654	6074	6540	7146	7704	9.30	<b>Centre - End</b>

MODULAR SEATING SYSTEMS

**ATO/...  
MODULAR SEATING SYSTEM  
CONFIGURATIONS**



	Code:	Description	COM /1	2	3	4	5	6	7	8	9	10	(ly)	(lb)
	<b>ATO/CO12/H</b>	(As Shown) High back without Arms	10186	-	11074	11396	11960	12364	13090	13896	14944	15910	16.10	Centre End
	<b>ATO/CO12/L</b>	Low Back without Arms	9608	-	10390	10674	11172	11528	12168	12878	13802	14654	14.20	Centre End
	<b>ATO/CO13/H</b>	(As Shown) High Back without Arms	13676	-	14860	15290	16044	16582	17550	18626	20024	21314	21.50	Centre End
	<b>ATO/CO13/L</b>	Low Back without Arms	12874	-	13916	14294	14956	15430	16282	17228	18458	19592	18.90	Centre End
	<b>ATO/CO14/H</b>	(As Shown) High Back with Arms	17376	-	18850	19386	20324	20994	22200	23540	25282	26890	26.80	Centre End
	<b>ATO/CO14/ H/A</b>	High Back without Arms	19728	-	21638	22332	23548	24416	25978	27714	29970	32052	34.70	Centre End
	<b>ATO/CO14/ H/B</b>	High Back with Closed Ends	19728	-	21638	22332	23548	24416	25978	27714	29970	32052	34.70	Centre End
	<b>ATO/CO14/L</b>	Low Back without Arms	16394	-	17692	18164	18990	19580	20642	21822	23356	24772	23.60	Centre End
	<b>ATO/CO14/ L/A</b>	Low Back with Arms	18614	-	20298	20910	21982	22748	24126	25656	27646	29482	30.60	Centre End

 Fabric Linear Yard  Product Weight

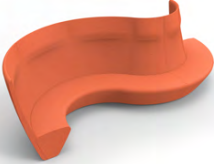

To view the 2D line drawings or to configure your own ATOM seating arrangement, please scan or click the QR code

**ATO/...  
MODULAR SEATING SYSTEM  
CONFIGURATIONS**

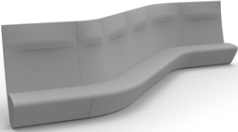
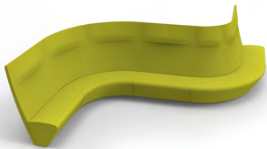
	Code:	Description	COM /1	2	3	4	5	6	7	8	9	10	(ly)	(lb)
	<b>ATO/C016/H</b>	(As Shown) High back without arms	20358	-	22130	22774	23902	24708	26158	27768	29862	31794	32.20	Centre End
	<b>ATO/C016/H/A</b>	High back with arms	22716	-	24924	25726	27130	28134	29940	31946	34554	36960	40.10	Centre End
	<b>ATO/C016/H/B</b>	High back with closed ends	22716	-	24924	25726	27130	28134	29940	31946	34554	36960	40.10	Centre End
	<b>ATO/C016/L</b>	Low back without arms	19216	-	20774	21340	22332	23040	24314	25730	27570	29268	28.30	Centre End
	<b>ATO/C016/L/A</b>	Low back with arms	21436	-	23380	24086	25322	26206	27796	29562	31858	33976	35.30	Centre End
	<b>ATO/C018/H</b>	(As Shown) High back without arms	20358	-	22130	22774	23902	24708	26158	27768	29862	31794	32.20	Centre End
	<b>ATO/C018/L</b>	Low back without arms	19216	-	20774	21340	22332	23040	24314	25730	27570	29268	28.30	Centre End
	<b>ATO/C019/H</b>	(As Shown) High back without arms	20358	-	22130	22774	23902	24708	26158	27768	29862	31794	32.20	Centre End
	<b>ATO/C019/H/A</b>	High back with arms	22716	-	24924	25726	27130	28134	29940	31946	34554	36960	40.10	Centre End
	<b>ATO/C019/H/B</b>	High back with closed ends	22716	-	24924	25726	27130	28134	29940	31946	34554	36960	40.10	Centre End
	<b>ATO/C019/L</b>	Low back without arms	19216	-	20774	21340	22332	23040	24314	25730	27570	29268	28.30	Centre End
	<b>ATO/C019/L/A</b>	Low back with arms	21436	-	23380	24086	25322	26206	27796	29562	31858	33976	35.30	Centre End
	<b>ATO/C021/H</b>	(As Shown) High back without arms	23346	-	25414	26166	27482	28422	30114	31994	34438	36694	37.60	Centre End
	<b>ATO/C021/H/A</b>	High back with arms	26740	-	29238	30146	31736	32872	34916	37186	40138	42862	45.40	Centre End
	<b>ATO/C021/H/B</b>	High back with closed ends	26740	-	29238	30146	31736	32872	34916	37186	40138	42862	45.40	Centre End
	<b>ATO/C021/L</b>	Low back without arms	22038	-	23854	24514	25670	26496	27982	29632	31778	33758	33.00	Centre End
	<b>ATO/C021/L/A</b>	Low back with arms	25154	-	27354	28154	29554	30554	32354	34354	36954	39354	40.00	Centre End





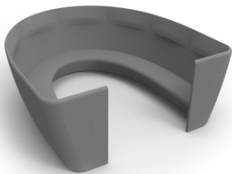

MODULAR SEATING SYSTEMS

**ATO/...  
MODULAR SEATING SYSTEM  
CONFIGURATIONS**

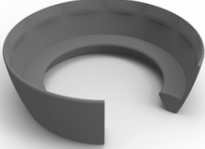

Code:	Description	COM /1	2	3	4	5	6	7	8	9	10	(ly)	(lb)
<b>ATO/C030/H</b>	High back without arms	20358	-	22130	22774	23902	24708	26158	27768	29862	31794	32.20	Centre End
<b>ATO/C030/H/A</b>	High back with arms	22716	-	24924	25726	27130	28134	29940	31946	34554	36960	40.10	Centre End
<b>ATO/C030/H/B</b>	(As Shown) High back with closed ends	22716	-	24924	25726	27130	28134	29940	31946	34554	36960	40.10	Centre End
<b>ATO/C030/L</b>	Low back without arms	19216	-	20774	21340	22332	23040	24314	25730	27570	29268	28.30	Centre End
<b>ATO/C030/L/A</b>	Low back with arms	21436	-	23380	24086	25322	26206	27796	29562	31858	33976	35.30	Centre End
<b>ATO/C033/H</b>	High back without arms	26330	-	28692	29550	31052	32126	34058	36204	38994	41568	42.90	Centre End
<b>ATO/C033/H/A</b>	High back with arms	28686	-	31480	32496	34274	35544	37830	40370	43672	46720	50.80	Centre End
<b>ATO/C033/H/B</b>	(As Shown) High back with closed ends	28686	-	31480	32496	34274	35544	37830	40370	43672	46720	50.80	Centre End
<b>ATO/C033/L</b>	Low back without arms	24858	-	26934	27688	29008	29952	31650	33536	35988	38250	37.70	Centre End
<b>ATO/C033/L/A</b>	Low back with arms	27078	-	29538	30432	31998	33116	35128	37364	40270	42952	44.70	Centre End



**ATO/...  
MODULAR SEATING SYSTEM  
CONFIGURATIONS**

	Code:	Description	COM/1	2	3	4	5	6	7	8	9	10	 (ly)	 (lb)
	<b>ATO/C034/H</b>	(As Shown) High back without arms	13168	-	14352	14782	15536	16074	17042	18118	19516	20806	21.50	<b>Centre</b> <b>End</b>
	<b>ATO/C034/L</b>	Low back without arms	12432	-	13474	13852	14514	14988	15840	16786	18016	19150	18.90	<b>Centre</b> <b>End</b>
	<b>ATO/C037/H</b>	(As Shown) High back without arms	33518	-	36466	37538	39414	40754	43166	45846	49330	52546	53.60	<b>Centre</b> <b>End</b>
	<b>ATO/C037/L</b>	Low back without arms	31640	-	34232	35174	36824	38002	40122	42478	45540	48366	47.10	<b>Centre</b> <b>End</b>
	<b>ATO/C038/H</b>	(As Shown) High back without arms	20358	-	22130	22774	23902	24708	26158	27768	29862	31794	32.20	<b>Centre</b> <b>End</b>
	<b>ATO/C038/L</b>	Low back without arms	19216	-	20774	21340	22332	23040	24314	25730	27570	29268	28.30	<b>Centre</b> <b>End</b>
	<b>ATO/C039/H</b>	(As Shown) High back without arms	33518	-	36466	37538	39414	40754	43166	45846	49330	52546	53.60	<b>Centre</b> <b>End</b>
	<b>ATO/C039/L</b>	Low back without arms	31640	-	34232	35174	36824	38002	40122	42478	45540	48366	47.10	<b>Centre</b> <b>End</b>
	<b>ATO/B001/H</b>	High back without arms	18814	-	20630	21290	22446	23272	24758	26408	28554	30534	33.00	<b>Centre</b> <b>End</b>
	<b>ATO/B001/ H/A</b>	High back with arms	21294	-	23538	24354	25782	26802	28636	30674	33324	35770	40.75	<b>Centre</b> <b>End</b>
	<b>ATO/B001/ H/B</b>	(As Shown) High back with closed ends	21294	-	23538	24354	25782	26802	28636	30674	33324	35770	40.75	<b>Centre</b> <b>End</b>

MODULAR SEATING SYSTEMS

 Fabric Linear Yard  Product Weight



To view the 2D line drawings or to configure your own ATOM seating arrangement, please scan or click the QR code

**Hemm**

Modular Seating Systems & Booths

**boss**





A modular family with distinct profiles. Where comfort meets every day ergonomics. Where individual meets integrated. Where choice meets configuration. Where color comes together seamlessly. Designed for you, Hemm is where work feels like home.

MODULAR SEATING SYSTEM & BOOTHS



# Hemm

boss

## Modular Seating Systems & Booths

### Hemm Single & Double Units

Available with and without side screens

Available as standalone units or in back to back configurations

Quilted fabric used is Camira Synergy Quilt (Channel)



HEM/1



HEM/2

### Hemm Booth Options

Hemm booth is available using single or double units

Available with built in Pixel power units, positioned in any of **three seat locations:**

Left, Centre and Right hand side  
Shown right

Hemm is also available in a Solo Focus Booth Configuration with integrated Laminate table



HEM/1/B/L/R

### Hemm Table Options

Reef Table - 1" (25mm) thick top  
Attached to partition

Square base

Black, White or polished base and stem finish options.

Rear table is available with a 1" (25mm) top

Both tables available in MDF

Writing Tablets available - booth units only

Zips - available in 10 standard zip colours as standard

#### Reef Table



#### RearTable



### Hemm Power & Data

Optional Pixel & Aircharge power units are available for an additional upcharge (includes upgraded table stem and base that accommodates power cables)

Power is placed centrally in the table stem

Pixel power is also available within the Hemm unit kick boards, located left, centre or right



ARC-H LD  
Black or White



Pixel  
1x Power +TUF



Phase  
1x Power, 1x TUF

# Specification

## Single Units

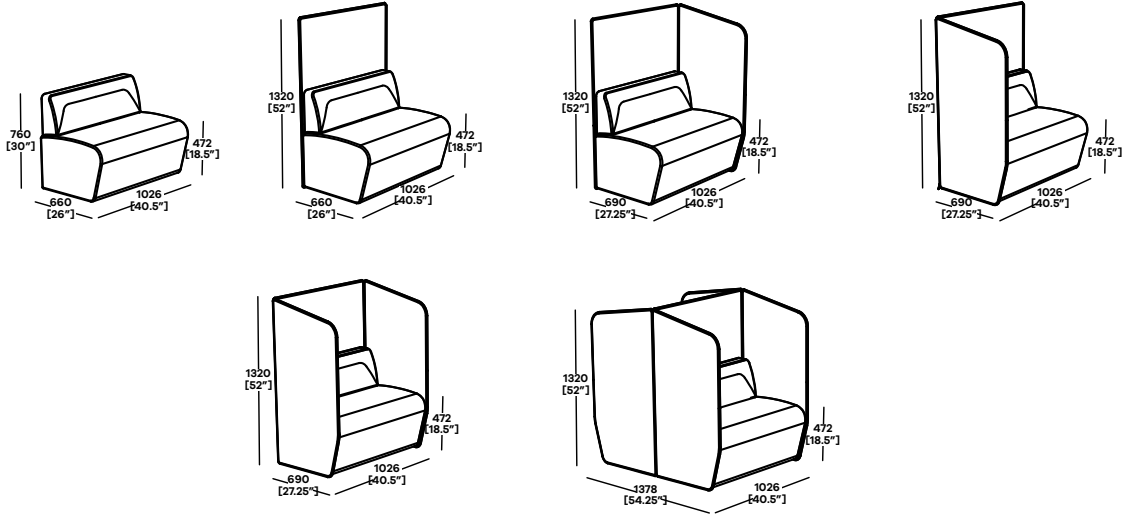

## Double units

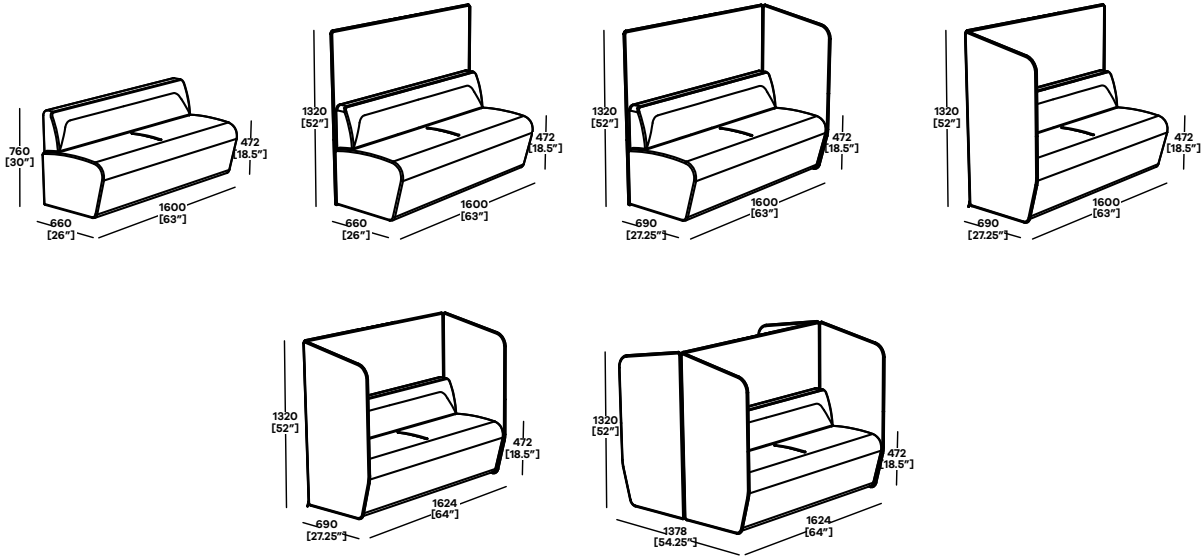

## Booth units

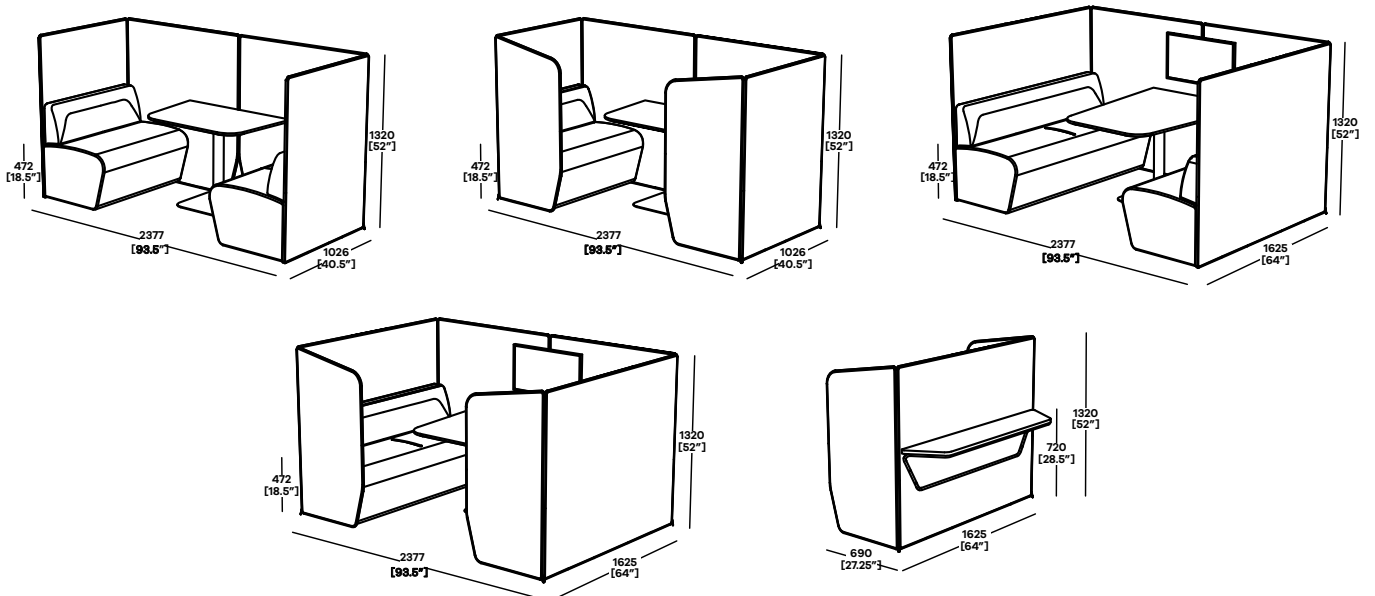

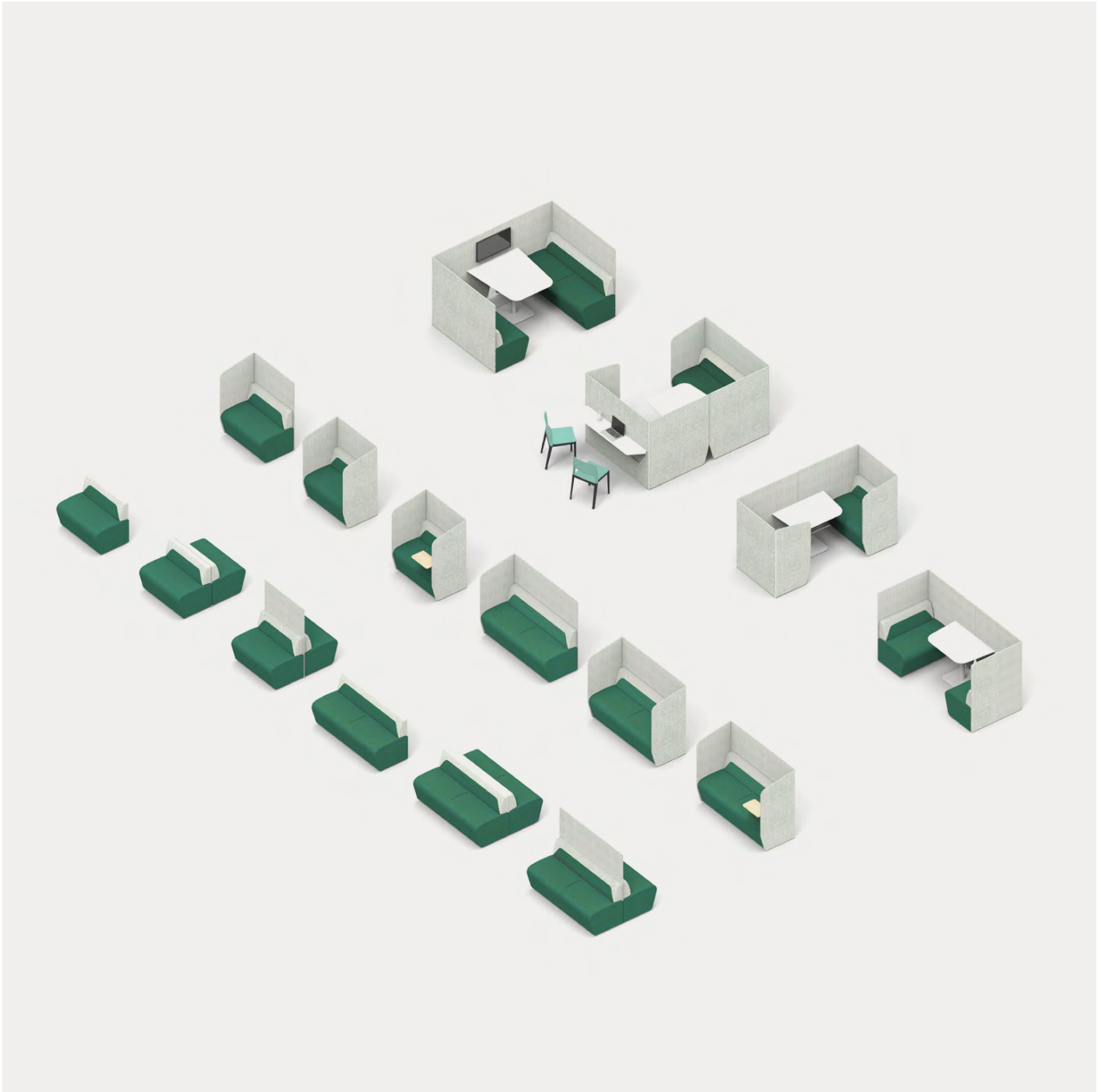







## Range Information

- Modular work lounge seating collection
- Hard wood frame
- CMHR foam
- Comfortable sprung seat
- Unique zip detail for acoustic screen surround
- Available with or without privacy screens (Screens cannot be removed once fitted)
- Unique stitch detail enabling a mix of fabric combinations
- Power and data is available with Pixels units applied to the lower seat. Available in left, central or right hand positions.
- If choosing power and data with a Reef table, the power unit is fitted within the table stem so an upgraded stem and base is required (\$64 upcharge). As a result the cables are managed within the Reef Stem and exit under the Reef base
- Reef table tops in Black or White Laminate and Black or White painted bases.
- Not recommended to be upholstered in Grade 1 fabrics

**HEM/1/  
ONE SEAT BOOTH**

	Code:	Description	COM /1	2	3	4	5	6	7	8	9	10	(ly)	(lb)
	HEM/1/	1x Single Seat Unit	2442	2556	2692	2782	2940	3054	3258	3484	3778	4048	4.50	-
	HEM/1/B	1x Single Seat Unit	2442	2556	2692	2782	2940	3054	3258	3484	3778	4048	4.50	-
		1x Back Screen	780	844	920	970	1058	1122	1236	1362	1526	1676	2.50	-
		<b>TOTAL</b>	<b>3222</b>	<b>3400</b>	<b>3612</b>	<b>3752</b>	<b>3998</b>	<b>4176</b>	<b>4494</b>	<b>4846</b>	<b>5304</b>	<b>5724</b>	<b>7.00</b>	<b>-</b>
	HEM/1/B/L	1x Single Seat Unit	2442	2556	2692	2782	2940	3054	3258	3484	3778	4048	4.50	-
		1x Back Screen	780	844	920	970	1058	1122	1236	1362	1526	1676	2.50	-
		1x Small Side Screen (Left)	646	690	744	780	842	886	966	1054	1168	1274	1.75	-
		<b>TOTAL</b>	<b>3868</b>	<b>4090</b>	<b>4356</b>	<b>4532</b>	<b>4840</b>	<b>5062</b>	<b>5460</b>	<b>5900</b>	<b>6472</b>	<b>6998</b>	<b>8.75</b>	<b>-</b>
	HEM/1/B/R	1x Single Seat Unit	2442	2556	2692	2782	2940	3054	3258	3484	3778	4048	4.50	-
		1x Back Screen	780	844	920	970	1058	1122	1236	1362	1526	1676	2.50	-
		1x Small Side Screen (Right)	646	690	744	780	842	886	966	1054	1168	1274	1.75	-
		<b>TOTAL</b>	<b>3868</b>	<b>4090</b>	<b>4356</b>	<b>4532</b>	<b>4840</b>	<b>5062</b>	<b>5460</b>	<b>5900</b>	<b>6472</b>	<b>6998</b>	<b>8.75</b>	<b>-</b>
	HEM/1/B/L/R	1x Single Seat Unit	2442	2556	2692	2782	2940	3054	3258	3484	3778	4048	4.50	-
		1x Back Screen	780	844	920	970	1058	1122	1236	1362	1526	1676	2.50	-
		1x Small Side Screen (Right)	646	690	744	780	842	886	966	1054	1168	1274	1.75	-
		1x Small Side Screen (Left)	646	690	744	780	842	886	966	1054	1168	1274	1.75	-
		<b>TOTAL</b>	<b>4514</b>	<b>4780</b>	<b>5100</b>	<b>5312</b>	<b>5682</b>	<b>5948</b>	<b>6426</b>	<b>6954</b>	<b>7640</b>	<b>8272</b>	<b>10.50</b>	<b>-</b>

MODULAR SEATING SYSTEM & BOOTHS

 Fabric Linear Yard  Product Weight







Scan or click me to view detailed dimensions for the complete Hemm Range

**Options**

CODE:	DESCRIPTION	\$
ZIP/... (COLOR)	Zipper - Available in 10 standard zip colors	included
HCH	Coat Hook - Price per unit	34



CODE:	DESCRIPTION	\$
HWT/LHS OR HWT/RHS	Writing tablet in White - Available in left or right hand sitting configurations	488

**HEM/2/  
TWO SEAT BOOTH**

	Code:	Description	COM /1	2	3	4	5	6	7	8	9	10	(ly)	(lb)
	<b>HEM/2</b>	1x Double Seat Unit	3340	3504	3700	3830	4058	4222	4516	4842	5266	5656	6.50	-
	<b>HEM/2/B</b>	1x Two Seat Unit	3340	3504	3700	3830	4058	4222	4516	4842	5266	5656	6.50	-
		1x Back Screen	1228	1328	1448	1528	1668	1768	1948	2148	2408	2648	4.00	-
		<b>TOTAL</b>	<b>4568</b>	<b>4832</b>	<b>5148</b>	<b>5358</b>	<b>5726</b>	<b>5990</b>	<b>6464</b>	<b>6990</b>	<b>7674</b>	<b>8304</b>	<b>10.50</b>	<b>-</b>
	<b>HEM/2/ B/L</b>	1x Two Seat Unit	3340	3504	3700	3830	4058	4222	4516	4842	5266	5656	6.50	-
		1x Back Screen	1228	1328	1448	1528	1668	1768	1948	2148	2408	2648	4.00	-
		1x Small Side Screen (Left)	646	690	744	780	842	886	966	1054	1168	1274	1.75	-
		<b>TOTAL</b>	<b>5214</b>	<b>5522</b>	<b>5892</b>	<b>6138</b>	<b>6568</b>	<b>6876</b>	<b>7430</b>	<b>8044</b>	<b>8842</b>	<b>9578</b>	<b>12.25</b>	<b>-</b>
	<b>HEM/2/ B/R</b>	1x Two Seat Unit	3340	3504	3700	3830	4058	4222	4516	4842	5266	5656	6.50	-
		1x Back Screen	1228	1328	1448	1528	1668	1768	1948	2148	2408	2648	4.00	-
		1x Small Side Screen (Right)	646	690	744	780	842	886	966	1054	1168	1274	1.75	-
		<b>TOTAL</b>	<b>5214</b>	<b>5522</b>	<b>5892</b>	<b>6138</b>	<b>6568</b>	<b>6876</b>	<b>7430</b>	<b>8044</b>	<b>8842</b>	<b>9578</b>	<b>12.25</b>	<b>-</b>
	<b>HEM/2/ B/L/R</b>	1x Two Seat Unit	3340	3504	3700	3830	4058	4222	4516	4842	5266	5656	6.50	-
		1x Back Screen	1228	1328	1448	1528	1668	1768	1948	2148	2408	2648	4.00	-
		1x Small Side Screen (Right)	646	690	744	780	842	886	966	1054	1168	1274	1.75	-
		1x Small Side Screen (Left)	646	690	744	780	842	886	966	1054	1168	1274	1.75	-
		<b>TOTAL</b>	<b>5860</b>	<b>6212</b>	<b>6636</b>	<b>6918</b>	<b>7410</b>	<b>7762</b>	<b>8396</b>	<b>9098</b>	<b>10010</b>	<b>10852</b>	<b>14.00</b>	<b>-</b>
		Add On - Rear Table in Laminate top as standard with Black Frame	1034	1034	1034	1034	1034	1034	1034	1034	1034	1034	1034	-



Scan or click me to view detailed dimensions for the complete Hemm Range

 Fabric Linear Yard  Product Weight

**Options**

CODE:	DESCRIPTION	\$
<b>ZIP/... (COLOR)</b>	Zipper - Available in 10 standard zip colors	included
<b>HCH</b>	Coat Hook - Price per unit	34

CODE:	DESCRIPTION	\$
<b>HWT/LHS OR HWT/RHS</b>	Writing tablet in White - Available in left or right hand sitting configurations	488



MODULAR SEATING SYSTEM & BOOTHS

**HEM/C CONFIGURATIONS**



**DIMENSIONS**  
 Height: 1320mm (52")  
 Width: 1026mm (40.5")  
 Depth: 1378mm (54.25")

Code:	Description	COM /1	2	3	4	5	6	7	8	9	10	(ly)	(lb)
<b>HEM/C2</b>	2x Single Seat Unit	4884	5112	5384	5564	5880	6108	6516	6968	7556	8096	9.00	-
	1x Single Back Screen	780	844	920	970	1058	1122	1236	1362	1526	1676	2.50	-
	2x Small Side Screen (Left)	1292	1380	1488	1560	1684	1772	1932	2108	2336	2548	3.50	-
	2x Small Side Screen (Right)	1292	1380	1488	1560	1684	1772	1932	2108	2336	2548	3.50	-
	<b>TOTAL</b>	<b>8248</b>	<b>8716</b>	<b>9280</b>	<b>9654</b>	<b>10306</b>	<b>10774</b>	<b>11616</b>	<b>12546</b>	<b>13754</b>	<b>14868</b>	18.50	-



Height: 1320mm (52")  
 Width: 1624mm (64")  
 Depth: 1378mm (54.25")

<b>HEM/C4</b>	2x Two Seat Unit	6680	7008	7400	7660	8116	8444	9032	9684	10532	11312	13.00	-
	1x Two Back Screen	1228	1328	1448	1528	1668	1768	1948	2148	2408	2648	4.00	-
	2x Small Side Screen (Left)	1292	1380	1488	1560	1684	1772	1932	2108	2336	2548	3.50	-
	2x Small Side Screen (Right)	1292	1380	1488	1560	1684	1772	1932	2108	2336	2548	3.50	-
	<b>TOTAL</b>	<b>10492</b>	<b>11096</b>	<b>11824</b>	<b>12308</b>	<b>13152</b>	<b>13756</b>	<b>14844</b>	<b>16048</b>	<b>17612</b>	<b>19056</b>	<b>24.00</b>	-



Height: 1320mm (52")  
 Width: 1026mm (40.5")  
 Depth: 2377mm (93.5")

<b>HEM/C6</b>	2x Single Seat Unit	4884	5112	5384	5564	5880	6108	6516	6968	7556	8096	9.00	-
	2x Single Back Screen	1560	1688	1840	1940	2116	2244	2472	2724	3052	3352	5.00	-
	1x Large Side Screen (Left)	710	790	886	950	1062	1142	1284	1442	1648	1838	3.15	-
	1x Large Side Screen (Right)	710	790	886	950	1062	1142	1284	1442	1648	1838	3.15	-
	<b>TOTAL</b>	<b>7864</b>	<b>8380</b>	<b>8996</b>	<b>9404</b>	<b>10120</b>	<b>10636</b>	<b>11556</b>	<b>12576</b>	<b>13904</b>	<b>15124</b>	<b>20.30</b>	-
<b>HEM/C6+</b>	Optional - Reef Table with Laminate top and Black or White base	954	954	954	954	954	954	954	954	954	954	-	-
	<b>Total + Reef</b>	<b>8818</b>	<b>9334</b>	<b>9950</b>	<b>10358</b>	<b>11074</b>	<b>11590</b>	<b>12510</b>	<b>13530</b>	<b>14858</b>	<b>16078</b>	<b>20.30</b>	-



Height: 1320mm (52")  
 Width: 1026mm (40.5")  
 Depth: 2377mm (93.5")

<b>HEM/C7</b>	2x Single Seat Unit	4884	5112	5384	5564	5880	6108	6516	6968	7556	8096	9.00	-
	2x Single Back Screen	1560	1688	1840	1940	2116	2244	2472	2724	3052	3352	5.00	-
	1x Large Side Screen (Left)	710	790	886	950	1062	1142	1284	1442	1648	1838	3.15	-
	1x Large Side Screen (Right)	710	790	886	950	1062	1142	1284	1442	1648	1838	3.15	-
	1x Small Side Screen (Left)	646	690	744	780	842	886	966	1054	1168	1274	1.75	-
	1x Small Side Screen (Right)	646	690	744	780	842	886	966	1054	1168	1274	1.75	-
	<b>TOTAL</b>	<b>9156</b>	<b>9760</b>	<b>10484</b>	<b>10964</b>	<b>11804</b>	<b>12408</b>	<b>13488</b>	<b>14684</b>	<b>16240</b>	<b>17672</b>	<b>23.80</b>	-
<b>HEM/C7+</b>	Optional - Reef Table with Laminate top and Black or White base	954	954	954	954	954	954	954	954	954	954	-	-
	<b>Total + Reef</b>	<b>10110</b>	<b>10714</b>	<b>11438</b>	<b>11918</b>	<b>12758</b>	<b>13362</b>	<b>14442</b>	<b>15638</b>	<b>17194</b>	<b>18626</b>	<b>23.80</b>	-

Fabric Linear Yard Product Weight



Scan or click me to view detailed dimensions for the complete Hemm Range

**HEM/C  
BOOTH CONFIGURATIONS**



Height: **1320mm (52")**  
Width: **1624mm (64")**  
Depth: **2377mm (93.5")**

Code:	Description	COM /1	2	3	4	5	6	7	8	9	10	(ly)	(lb)	
<b>HEM/C8</b>	2x Two Seat Unit	6680	7008	7400	7660	8116	8444	9032	9684	10532	11312	13.00	-	
	2x Two Back Screen	2456	2656	2896	3056	3336	3536	3896	4296	4816	5296	8.00	-	
	1x Large Side Screen (Left)	710	790	886	950	1062	1142	1284	1442	1648	1838	3.15	-	
	1x Large Side Screen (Right)	710	790	886	950	1062	1142	1284	1442	1648	1838	3.15	-	
	TV Panel Mount	130	144	160	170	188	202	226	252	286	316	0.50	-	
	<b>TOTAL</b>		<b>10686</b>	<b>11388</b>	<b>12228</b>	<b>12786</b>	<b>13764</b>	<b>14466</b>	<b>15722</b>	<b>17116</b>	<b>18930</b>	<b>20600</b>	<b>27.80</b>	-
<b>HEM/C8+</b>	Optional - Reef Table with Laminate top and Black or White base	14692	15768	17056	17912	19412	20488	22412	24548	27328	29888	-	-	
	<b>Total + Reef</b>		<b>25378</b>	<b>27156</b>	<b>29284</b>	<b>30698</b>	<b>33176</b>	<b>34954</b>	<b>38134</b>	<b>41664</b>	<b>46258</b>	<b>50488</b>	<b>27.80</b>	-
<b>HEM/C9</b>	2x Two Seat Unit	6680	7008	7400	7660	8116	8444	9032	9684	10532	11312	13.00	-	
	2x Two Back Screen	2456	2656	2896	3056	3336	3536	3896	4296	4816	5296	8.00	-	
	1x Large Side Screen (Left)	710	790	886	950	1062	1142	1284	1442	1648	1838	3.15	-	
	1x Large Side Screen (Right)	710	790	886	950	1062	1142	1284	1442	1648	1838	3.15	-	
	1x Small Side Screen (Left)	646	690	744	780	842	886	966	1054	1168	1274	1.75	-	
	1x Small Side Screen (Right)	646	690	744	780	842	886	966	1054	1168	1274	1.75	-	
	TV Panel Mount	130	144	160	170	188	202	226	252	286	316	0.50	-	
	<b>TOTAL</b>		<b>11978</b>	<b>12768</b>	<b>13716</b>	<b>14346</b>	<b>15448</b>	<b>16238</b>	<b>17654</b>	<b>19224</b>	<b>21266</b>	<b>23148</b>	<b>31.30</b>	-
<b>HEM/C9+</b>	Optional - Reef Table with Laminate top and Black or White base	14692	15768	17056	17912	19412	20488	22412	24548	27328	29888	-	-	
	<b>Total + Reef</b>		<b>26670</b>	<b>28536</b>	<b>30772</b>	<b>32258</b>	<b>34860</b>	<b>36726</b>	<b>40066</b>	<b>43772</b>	<b>48594</b>	<b>53036</b>	<b>31.30</b>	-
	Optional - Rear Table in Laminate top as standard with Black Frame	1034	1034	1034	1034	1034	1034	1034	1034	1034	1034	-	-	



Height: **1320mm (52")**  
Width: **1624mm (64")**  
Depth: **2377mm (93.5")**

MODULAR SEATING SYSTEM & BOOTHS

Fabric Linear Yard Product Weight

**Reef Table - Upgrade Painted Base Colors - \$250 per color per table**



RAL 060 60 05



RAL 240 20 22



RAL 240 20 22



RAL 130 30 20



RAL 040 50 50



RAL 070 70 80

CODE:	DESCRIPTION	\$
<b>ZIP/... (COLOR)</b>	Zipper - Available in 10 standard zip colors	Included
<b>HCH</b>	Coat Hook (Price per unit)	34
<b>HWT/LHS OR HWT/RHS</b>	Writing tablet in White - Available in left or right hand sitting configurations	488

**HEM/SOLO**  
**SOLO WORKING BOOTH**

Code:	Description	COM /1	2	3	4	5	6	7	8	9	10	(ly)	(lb)
<b>HEM/SOLO/LH</b>	Hemm Solo Work Booth with return Laminate Table with a single grommet positioned left hand side	4978	5328	5748	6028	6518	6868	7498	8198	9108	9948	14.00	-
<b>HEM/SOLO/RH</b>	Hemm Solo Work Booth with return Laminate Table with a single grommet positioned right hand side	4978	5328	5748	6028	6518	6868	7498	8198	9108	9948	14.00	-

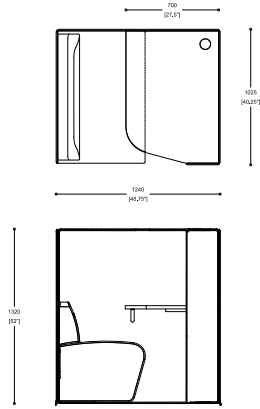

Fabric Linear Yard Product Weight



Scan or click me to view detailed dimensions for the complete Hemm Range

**Options**

CODE:	DESCRIPTION	\$
<b>ZIP/... (COLOR)</b>	Zipper - 10 standard zip colors are available	Included
<b>HCH</b>	Coat Hook (Price per unit)	34

**Zip Colors**





MODULAR SEATING SYSTEM & BOOTHS





## Range Information

- Hardwood & plywood internal frame
- CMHR foam seat cushion
- CMHR fixed foam back
- Webbed back support
- Top stitch detail
- Timber: Beech
- Where units are to be linked (and linking mechanisms required), a plan drawing must be submitted to confirm the layout required
- 1 No. 18" Scatter Cushion provided per Arm
- Not recommended to be upholstered in Grade 1 fabrics



<b>IMO/1</b> <b>1 SEAT ARMLESS</b>	<b>Code:</b>	<b>Description</b>	<b>COM</b> <b>/1</b>	<b>2</b>	<b>3</b>	<b>4</b>	<b>5</b>	<b>6</b>	<b>7</b>	<b>8</b>	<b>9</b>	<b>10</b>	<b>COL</b>	<b>L1</b>	<b>L2</b>	<b>L3</b>			
	<b>IMO/1</b>	Imogen 1 seat armless	1998	2096	2214	2292	2430	2528	2704	2900	3154	3388	2118	3208	3874	5910	3.90	70	-
<b>DIMENSIONS</b> Height: <b>780mm (30.75")</b> Width: <b>660mm (26")</b> Depth: <b>860mm (33.75")</b> Seat Height: <b>460mm (18")</b>																			

<b>IMO/2</b> <b>2 SEAT ARMLESS</b>	<b>Code:</b>	<b>Description</b>	<b>COM</b> <b>/1</b>	<b>2</b>	<b>3</b>	<b>4</b>	<b>5</b>	<b>6</b>	<b>7</b>	<b>8</b>	<b>9</b>	<b>10</b>	<b>COL</b>	<b>L1</b>	<b>L2</b>	<b>L3</b>			
	<b>IMO/2</b>	Imogen 2 seat sofa armless	2778	2916	3082	3192	3386	3524	3772	4048	4406	4736	2946	4482	5422	8292	5.50	99	-
<b>DIMENSIONS</b> Height: <b>780mm (30.75")</b> Width: <b>1290mm (50.75")</b> Depth: <b>860mm (33.75")</b> Seat Height: <b>460mm (18")</b>																			

<b>IMO/3</b> <b>2 SEAT SOFA</b>	<b>Code:</b>	<b>Description</b>	<b>COM</b> <b>/1</b>	<b>2</b>	<b>3</b>	<b>4</b>	<b>5</b>	<b>6</b>	<b>7</b>	<b>8</b>	<b>9</b>	<b>10</b>	<b>COL</b>	<b>L1</b>	<b>L2</b>	<b>L3</b>			
 	<b>IMO/3</b> <b>LH OR RH</b>	Imogen 2 seat sofa single arm LH or RH	3376	3572	3806	3962	4236	4432	4784	5174	5682	6150	3608	5786	7118	11190	7.80	140	-
<b>DIMENSIONS</b> Height: <b>780mm (30.75")</b> Width: <b>1500mm (59")</b> Depth: <b>860mm (33.75")</b> Seat Height: <b>460mm (18")</b>																			

**Options**

<b>CODE:</b>	<b>DESCRIPTION</b>	<b>\$</b>
<b>CODE</b>	Set of 2 linking clips	110

MODULAR SEATING SYSTEM

**IMO/4**  
2 SEAT SOFA

**Code:**      **Description**      **COM**    2    3    4    5    6    7    8    9    10    COL    L1    L2    L3

(ly)    (ft²)    (lb)



**IMO/4**    Imogen 2 seat sofa    3820   4068   4366   4564   4912   5160   5606   6102   6746   7340   4110   6874   8566   13734   9.90   178   -

**DIMENSIONS**

Height:    **780mm (30.75")**  
Width:     **1690mm (59")**  
Depth:    **860mm (33.75")**  
Seat Height: **460mm (18")**

**IMO/5**  
3 SEAT SOFA

**Code:**      **Description**      **COM**    2    3    4    5    6    7    8    9    10    COL    L1    L2    L3

(ly)    (ft²)    (lb)

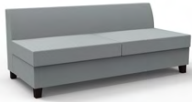

**IMO/5**    Imogen 3 seat sofa armless    3582   3778   4012   4168   4442   4638   4990   5380   5888   6356   3816   5994   7326   11398   7.80   140   -

**DIMENSIONS**

Height:    **780mm (30.75")**  
Width:     **1920mm (75.5")**  
Depth:    **860mm (33.75")**  
Seat Height: **460mm (18")**

**IMO/6**  
3 SEAT SOFA

**Code:**      **Description**      **COM**    2    3    4    5    6    7    8    9    10    COL    L1    L2    L3

(ly)    (ft²)    (lb)

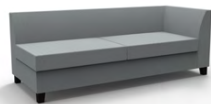

**IMO/6**  
**LH OR RH**    Imogen 3 seat sofa single arm LH or RH    4030   4280   4580   4780   5130   5380   5830   6330   6980   7580   4324   7114   8824   14044   10.00   180   -

**DIMENSIONS**





Height:    **780mm (30.75")**  
Width:     **2140mm (84.25")**  
Depth:    **860mm (33.75")**  
Seat Height: **460mm (18")**





N.B. Leather is a natural material which will crease and 'puddle'.





Fabric Linear Yard    Leather Square Footage    Product Weight

**Options**

CODE:	DESCRIPTION	\$
<b>CODE</b>	Set of 2 linking clips	110

<b>IMO/7 3 SEAT SOFA</b>	<b>Code:</b>	<b>Description</b>	<b>COM</b>	<b>2</b>	<b>3</b>	<b>4</b>	<b>5</b>	<b>6</b>	<b>7</b>	<b>8</b>	<b>9</b>	<b>10</b>	<b>COL</b>	<b>L1</b>	<b>L2</b>	<b>L3</b>			
			<b>/1</b>														(ly)	(ft²)	(lb)
	<b>IMO/7</b>	Imogen 3 seat sofa	4370	4670	5030	5270	5690	5990	6530	7130	7910	8630	4718	8066	10118	16382	12.00	216	-
<b>DIMENSIONS</b> Height: <b>780mm (30.75")</b> Width: <b>2330mm (91.75")</b> Depth: <b>860mm (33.75")</b> Seat Height: <b>460mm (18")</b>																			

<b>IMO/8 CORNER UNIT</b>	<b>Code:</b>	<b>Description</b>	<b>COM</b>	<b>2</b>	<b>3</b>	<b>4</b>	<b>5</b>	<b>6</b>	<b>7</b>	<b>8</b>	<b>9</b>	<b>10</b>	<b>COL</b>	<b>L1</b>	<b>L2</b>	<b>L3</b>			
			<b>/1</b>														(ly)	(ft²)	(lb)
	<b>IMO/8</b>	Imogen corner unit	2656	2832	3042	3182	3428	3604	3920	4270	4726	5146	2862	4816	6012	9666	7.00	126	-
<b>DIMENSIONS</b> Height: <b>780mm (30.75")</b> Width: <b>860mm (33.75")</b> Depth: <b>860mm (33.75")</b> Seat Height: <b>460mm (18")</b>																			

<b>IMO/9 CHAISE</b>	<b>Code:</b>	<b>Description</b>	<b>COM</b>	<b>2</b>	<b>3</b>	<b>4</b>	<b>5</b>	<b>6</b>	<b>7</b>	<b>8</b>	<b>9</b>	<b>10</b>	<b>COL</b>	<b>L1</b>	<b>L2</b>	<b>L3</b>			
			<b>/1</b>														(ly)	(ft²)	(lb)
 	<b>IMO/9 LH OR RH</b>	Imogen chaise LH or RH	3582	3782	4022	4182	4462	4662	5022	5422	5942	6422	3820	6052	7420	11596	8.00	144	-
<b>DIMENSIONS</b> Height: <b>780mm (30.75")</b> Width: <b>1500mm (59")</b> Depth: <b>860mm (33.75")</b> Seat Height: <b>460mm (18")</b>																			

N.B. Leather is a natural material which will crease and 'puddle'.

 Fabric Linear Yard  Leather Square Footage  Product Weight

**Options**

<b>CODE:</b>	<b>DESCRIPTION</b>	<b>\$</b>
<b>CODE</b>	Set of 2 linking clips	110

MODULAR SEATING SYSTEM

**IMO/10  
STANDARD FOOTSTOOL**

**Code:**      **Description**      **COM**    **2**    **3**    **4**    **5**    **6**    **7**    **8**    **9**    **10**    **COL**    **L1**    **L2**    **L3**

 (ly)     (ft²)     (lb)



**IMO/10**    Imogen standard footstool    1422    1506    1606    1672    1788    1872    2022    2188    2404    2602    1522    2444    3008    4730    3.30    59    -

**DIMENSIONS**

Height:    **780mm (30.75")**  
Width:     **660mm (26")**  
Depth:    **860mm (33.75")**  
Seat Height: **460mm (18")**

**IMO/11  
LARGE FOOTSTOOL**

**Code:**      **Description**      **COM**    **2**    **3**    **4**    **5**    **6**    **7**    **8**    **9**    **10**    **COL**    **L1**    **L2**    **L3**

 (ly)     (ft²)     (lb)

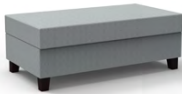

**IMO/11**    Imogen large footstool    1734    1834    1954    2034    2174    2274    2454    2654    2914    3154    1854    2970    3654    5742    4.00    72    -

**DIMENSIONS**

Height:    **780mm (30.75")**  
Width:     **1260mm (49.5")**  
Depth:    **660mm (26")**  
Seat Height: **460mm (18")**

N.B. Leather is a natural material which will crease and 'puddle'.

 **Fabric Linear Yard**     **Leather Square Footage**     **Product Weight**

**Options**

<b>CODE:</b>	<b>DESCRIPTION</b>	<b>\$</b>
<b>CODE</b>	Set of 2 linking clips	110

**Configuration 1 - Right Hand Shown**



**Configuration 2 - Right Hand Shown**



**Configuration 3**



**Configuration 4**



## How To Specify Myriad

### 1. Choose Your Model

The first part of building the product code is to select the seat model of the furniture that you require.

In our example, we are specifying a Myriad 2 seater unit, in 'Two-tone Option 1' (MYR/2/B/TT1)

In this case, we want a grade 3 outer fabric with a grade 5 inner fabric.

**Unit Price: \$3,558**



### 2. Select Your Options

Next you need to select the leg finish. Black, White or an Oak lacquered finish. In our example, we would choose white legs with suffix 'W' to specify a white legged option.

The final unit product code for this specification would be 'MYR/2/B/TT1/W'.

**Options Cost: \$Included**

#### Aluminum Leg

Cast Aluminum



#### Tubular Steel Leg

White

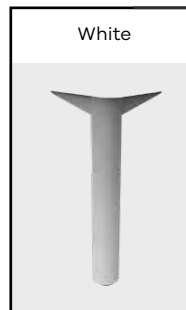

Black

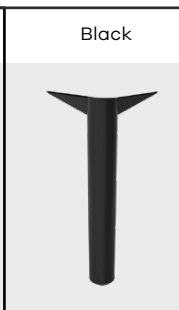

#### Steel & Wooden Leg

Oak Lacquer



### 3. Optional Extras

From here you can add any options such as tables, screens or arm rests. These feature separate product codes which you add separately to your order.

For example when adding an Oval linking table in Laminate, you would add the code 'MYR/A/TAB/OV/Laminate'.

**Extra Cost: \$490**



See arm options

## Two Seater with Back

Single Fabric

Two-Tone Option 1

Two-Tone Option 2

MYR/2/B

MYR/2/B/TT1

MYR/2/B/TT2



MYR/2/B	Fabric Grade Options	Band	COM / 1										(ly)	(lb)
			2	3	4	5	6	7	8	9	10			
		-	3268	3356	3462	3532	3656	3744	3902	4078	4306	4516	4	
	Two Tone 1 - TT1	-	Inner Fabric											
	Outer Fabric	COM / 1	3268	3312	3366	3400	3462	3506	3584	3672	3786	3890	2	
		2	3312	3356	3408	3444	3506	3548	3628	3716	3828	3934	2	
		3	3366	3408	3462	3496	3558	3602	3680	3768	3882	3986	2	
		4	3400	3444	3496	3532	3592	3636	3716	3802	3916	4022	2	
		5	3462	3506	3558	3592	3656	3698	3776	3864	3978	4082	2	
		6	3506	3548	3602	3636	3698	3744	3820	3908	4022	4126	2	
		7	3584	3628	3680	3716	3776	3820	3902	3986	4100	4206	2	
		8	3672	3716	3768	3802	3864	3908	3986	4078	4188	4292	2	
		9	3786	3828	3882	3916	3978	4022	4100	4188	4306	4406	2	
		10	3890	3934	3986	4022	4082	4126	4206	4292	4406	4516	2	
	Two Tone 2 - TT2	-	Seat Fabric											
	Back Fabric	COM / 1	3348	3436	3540	3610	3732	3820	3978	4152	4380	4590	4	
		2	3392	3478	3584	3654	3776	3864	4022	4196	4424	4634	4	
		3	3444	3532	3636	3706	3828	3916	4074	4248	4476	4686	4	
		4	3478	3566	3672	3742	3864	3952	4108	4284	4512	4722	4	
		5	3540	3628	3732	3802	3926	4012	4170	4346	4572	4782	4	
		6	3584	3672	3776	3846	3968	4056	4214	4388	4616	4826	4	
		7	3662	3750	3856	3926	4048	4136	4292	4468	4696	4906	4	
		8	3750	3838	3942	4012	4136	4222	4380	4556	4782	4992	4	
		9	3864	3952	4056	4126	4248	4336	4494	4668	4896	5106	4	
		10	3968	4056	4162	4232	4354	4442	4598	4774	5002	5212	4	

**DIMENSIONS**

Height: 790mm (31")  
 Width: 1340mm (52.75")  
 Depth: 670mm (26.5")  
 Seat Height: 460mm (18")

MODULAR SEATING SYSTEMS

MODULAR SEATING SYSTEMS

**LEG OPTIONS**



	CODE	DESCRIPTION	\$
CAST ALUMINUM LEG	'B' OR 'W'	Black or white painted cast aluminum leg	No Upcharge
	POLISHED	Polished aluminum leg	No Upcharge
STEEL LEG	'B' OR 'W'	Painted black or white tubular steel leg	No Upcharge
OAK LEG - WHITE COLLAR		Oak lacquered leg with white painted collar	No Upcharge

**MYR/A/TAB... MYRIAD LINKING TABLES.**



MYR/A/TAB/... Linking Table	Code:	Cost Per Unit (\$)		(lb)
		Laminate Top Finish	Veneer Top Finish	
	MYR/A/TAB/PLEC	490	POA	-
	MYR/A/TAB/OV	490	POA	-
Linking plate to link seating units. One required per end, per unit. Price PER PLATE	LINKING PLATE	68 Per linking plate		-

www.bosdesign.com/us



### Range Information

- With the increasing need for your furniture to be flexible, Myriad allows you to create a comfortable meeting area, private huddle space or a stunning island. The possibilities are truly infinite with this versatile range.
- Comprehensive range of eleven reconfigurable pieces
- Molded Foam seat and backrest
- Solid plywood internal frame
- Sprung seat
- Clear lacquered Oak, painted tubular steel or cast aluminum leg options
- Choice of black or white painted legs (Other Boss Standard RAL colors available)
- Integrated power and data modules available
- Not recommended to be upholstered in Grade 1 fabrics



# Single Seat



MYR/1	Fabric Grade Options	Band	Single Fabric										Two-Tone Option 1	
			COM / 1	2	3	4	5	6	7	8	9	10	(ly)	(lb)
	Single Fabric	-	2062	2112	2172	2212	2282	2332	2422	2522	2652	2772	2	
	Two Tone 1 - TT1	-	IF - Inner Fabric											
	OF - Outer Fabric	COM / 1	2062	2088	2118	2138	2172	2198	2242	2292	2358	2418	1	
		2	2088	2112	2142	2162	2198	2222	2268	2318	2382	2442	1	
		3	2118	2142	2172	2192	2228	2252	2298	2348	2412	2472	1	
		4	2138	2162	2192	2212	2248	2272	2318	2368	2432	2492	1	
		5	2172	2198	2228	2248	2282	2308	2352	2402	2468	2528	1	
		6	2198	2222	2252	2272	2308	2332	2378	2428	2492	2552	1	
		7	2242	2268	2298	2318	2352	2378	2422	2472	2538	2598	1	
		8	2292	2318	2348	2368	2402	2428	2472	2522	2588	2648	1	
		9	2358	2382	2412	2432	2468	2492	2538	2588	2652	2712	1	
		10	2418	2442	2472	2492	2528	2552	2598	2648	2712	2772	1	

**DIMENSIONS**  
 Height: 460mm (18")  
 Width: 670mm (26.5")  
 Depth: 670mm (26.5")  
 Seat Height: 460mm (18")

# Single Seat with Back



MYR/1/B	Fabric Grade Options	Band	Single Fabric						Two-Tone Option 1			Two-Tone Option 2	
			COM / 1	2	3	4	5	6	7	8	9	10	(ly)
		-	2646	2696	2756	2796	2866	2916	3006	3106	3236	3356	2
	Two Tone 1 - TT1	-	Inner Fabric										
	Outer Fabric	COM / 1	2646	2700	2738	2764	2806	2838	2894	2956	3038	3114	1
		2	2700	2732	2770	2794	2838	2870	2926	2988	3070	3144	1
		3	2738	2770	2806	2832	2876	2906	2964	3026	3106	3182	1
		4	2764	2794	2832	2856	2900	2932	2988	3050	3132	3206	1
		5	2806	2838	2876	2900	2944	2976	3032	3094	3176	3250	1
		6	2838	2870	2906	2932	2976	3006	3064	3126	3206	3282	1
		7	2894	2926	2964	2988	3032	3064	3120	3182	3264	3338	1
		8	2956	2988	3026	3050	3094	3126	3182	3244	3326	3400	1
		9	3038	3070	3106	3132	3176	3206	3264	3326	3406	3482	1
		10	3114	3144	3182	3206	3250	3282	3338	3400	3482	3556	1
	Two Tone 2 - TT2	-	Seat Fabric										
	Back Fabric	COM / 1	2646	2700	2738	2764	2806	2838	2894	2956	3038	3114	1
		2	2700	2732	2770	2794	2838	2870	2926	2988	3070	3144	1
		3	2738	2770	2806	2832	2876	2906	2964	3026	3106	3182	1
		4	2764	2794	2832	2856	2900	2932	2988	3050	3132	3206	1
		5	2806	2838	2876	2900	2944	2976	3032	3094	3176	3250	1
		6	2838	2870	2906	2932	2976	3006	3064	3126	3206	3282	1
		7	2894	2926	2964	2988	3032	3064	3120	3182	3264	3338	1
		8	2956	2988	3026	3050	3094	3126	3182	3244	3326	3400	1
		9	3038	3070	3106	3132	3176	3206	3264	3326	3406	3482	1
		10	3114	3144	3182	3206	3250	3282	3338	3400	3482	3556	1

**DIMENSIONS**  
 Height: 790mm (31")  
 Width: 670mm (26.5")  
 Depth: 670mm (26.5")  
 Seat Height: 460mm (18")

Fabric Linear Yard Product Weight

MODULAR SEATING SYSTEMS

# Corner Unit with Back

Single Fabric

Two-Tone Option 1

Two-Tone Option 2

MYR/C/B

MYR/C/B/TT1

MYR/C/B/TT2



MYR/C/B

Fabric Grade Options

Band

COM / 1

2

3

4

5

6

7

8

9

10

(ly)

(lb)

			COM / 1	2	3	4	5	6	7	8	9	10	(ly)	(lb)
		-	3682	3752	3836	3892	3990	4060	4184	4322	4502	4668	3	
	Two Tone 1 - TT1	-	Inner Fabric											
	Outer Fabric	COM / 1	3682	3760	3812	3848	3910	3952	4032	4120	4232	4338	2	
		2	3760	3804	3856	3892	3952	3996	4076	4162	4276	4382	2	
		3	3812	3856	3910	3944	4006	4050	4128	4216	4330	4434	2	
		4	3848	3892	3944	3980	4040	4084	4162	4250	4364	4470	2	
		5	3910	3952	4006	4040	4102	4146	4224	4312	4426	4530	2	
		6	3952	3996	4050	4084	4146	4190	4268	4356	4470	4574	2	
		7	4032	4076	4128	4162	4224	4268	4346	4434	4548	4652	2	
		8	4120	4162	4216	4250	4312	4356	4434	4522	4636	4740	2	
		9	4232	4276	4330	4364	4426	4470	4548	4636	4750	4854	2	
		10	4338	4382	4434	4470	4530	4574	4652	4740	4854	4960	2	
	Two Tone 2 - TT2	-	Seat Fabric											
	Back Fabric	COM / 1	3682	3718	3758	3786	3834	3868	3930	4000	4088	4172	2	
		2	3718	3752	3792	3820	3868	3902	3964	4034	4122	4206	2	
		3	3758	3792	3836	3862	3910	3944	4006	4074	4164	4246	2	
		4	3786	3820	3862	3892	3938	3972	4034	4102	4192	4274	2	
		5	3834	3868	3910	3938	3990	4020	4082	4150	4240	4322	2	
		6	3868	3902	3944	3972	4020	4060	4116	4184	4274	4356	2	
		7	3930	3964	4006	4034	4082	4116	4184	4246	4336	4418	2	
		8	4000	4034	4074	4102	4150	4184	4246	4322	4404	4488	2	
		9	4088	4122	4164	4192	4240	4274	4336	4404	4502	4576	2	
		10	4172	4206	4246	4274	4322	4356	4418	4488	4576	4668	2	

**DIMENSIONS**

Height: 790mm (31")  
 Width: 670mm (26.5")  
 Depth: 670mm (26.5")  
 Seat Height: 460mm (18")

# Two Seat without Back

Single Fabric

Two-Tone Option 1

MYR/2

MYR/2/TT1



MYR/2

Fabric Grade Options

Band

COM / 1

2

3

4

5

6

7

8

9

10

(ly)

(lb)

			COM / 1	2	3	4	5	6	7	8	9	10	(ly)	(lb)
	Single Fabric	-	2442	2530	2636	2706	2830	2918	3076	3252	3480	3690	4	
	Two Tone 1 - TT1	-	IF - Inner Fabric											
	OF - Outer Fabric	COM / 1	2442	2486	2540	2574	2636	2680	2758	2846	2960	3064	2 x 2	
		2	2486	2530	2582	2618	2680	2722	2802	2890	3002	3108	2 x 2	
		3	2540	2582	2636	2670	2732	2776	2854	2942	3056	3160	2 x 2	
		4	2574	2618	2670	2706	2766	2810	2890	2976	3090	3196	2 x 2	
		5	2636	2680	2732	2766	2830	2872	2950	3038	3152	3256	2 x 2	
		6	2680	2722	2776	2810	2872	2918	2994	3082	3196	3300	2 x 2	
		7	2758	2802	2854	2890	2950	2994	3076	3160	3274	3380	2 x 2	
		8	2846	2890	2942	2976	3038	3082	3160	3252	3362	3466	2 x 2	
		9	2960	3002	3056	3090	3152	3196	3274	3362	3480	3580	2 x 2	
		10	3064	3108	3160	3196	3256	3300	3380	3466	3580	3690	2 x 2	

**DIMENSIONS**

Height: 460mm (18")  
 Width: 1340mm (52.75")  
 Depth: 670mm (26.5")  
 Seat Height: 460mm (18")

Fabric Linear Yard Product Weight

# Two Seater with Back



MYR/2/B	Fabric Grade Options	Band	Single Fabric						Two-Tone Option 1			Two-Tone Option 2		(ly)	(lb)
			COM / 1	2	3	4	5	6	7	8	9	10			
		-	3268	3356	3462	3532	3656	3744	3902	4078	4306	4516	4		
	Two Tone 1 - TT1	-	Inner Fabric												
	Outer Fabric	COM / 1	3268	3312	3366	3400	3462	3506	3584	3672	3786	3890	2		
		2	3312	3356	3408	3444	3506	3548	3628	3716	3828	3934	2		
		3	3366	3408	3462	3496	3558	3602	3680	3768	3882	3986	2		
		4	3400	3444	3496	3532	3592	3636	3716	3802	3916	4022	2		
		5	3462	3506	3558	3592	3656	3698	3776	3864	3978	4082	2		
		6	3506	3548	3602	3636	3698	3744	3820	3908	4022	4126	2		
		7	3584	3628	3680	3716	3776	3820	3902	3986	4100	4206	2		
		8	3672	3716	3768	3802	3864	3908	3986	4078	4188	4292	2		
		9	3786	3828	3882	3916	3978	4022	4100	4188	4306	4406	2		
		10	3890	3934	3986	4022	4082	4126	4206	4292	4406	4516	2		
	Two Tone 2 - TT2	-	Seat Fabric												
	Back Fabric	COM / 1	3348	3436	3540	3610	3732	3820	3978	4152	4380	4590	4		
		2	3392	3478	3584	3654	3776	3864	4022	4196	4424	4634	4		
		3	3444	3532	3636	3706	3828	3916	4074	4248	4476	4686	4		
		4	3478	3566	3672	3742	3864	3952	4108	4284	4512	4722	4		
		5	3540	3628	3732	3802	3926	4012	4170	4346	4572	4782	4		
		6	3584	3672	3776	3846	3968	4056	4214	4388	4616	4826	4		
		7	3662	3750	3856	3926	4048	4136	4292	4468	4696	4906	4		
		8	3750	3838	3942	4012	4136	4222	4380	4556	4782	4992	4		
		9	3864	3952	4056	4126	4248	4336	4494	4668	4896	5106	4		
		10	3968	4056	4162	4232	4354	4442	4598	4774	5002	5212	4		

**DIMENSIONS**  
 Height: 790mm (31")  
 Width: 1340mm (52.75")  
 Depth: 670mm (26.5")  
 Seat Height: 460mm (18")

MODULAR SEATING SYSTEMS

# 90° without Back



MYR/90	Fabric Grade Options	Band	Single Fabric						Two-Tone Option 1				(ly)	(lb)
			COM / 1	2	3	4	5	6	7	8	9	10		
	Single Fabric	-	3780	3940	4132	4260	4484	4644	4932	5252	5668	6052	6	-
	Two Tone 1 - TT1	-	IF - Inner Fabric											
	OF - Outer Fabric	COM / 1	3780	3860	3956	4020	4132	4212	4356	4516	4724	4916	3 x2	-
		2	3860	3940	4036	4100	4212	4292	4436	4596	4804	4996	3 x2	-
		3	3956	4036	4132	4196	4308	4388	4532	4692	4900	5092	3 x2	-
		4	4020	4100	4196	4260	4372	4452	4596	4756	4964	5156	3 x2	-
		5	4132	4212	4308	4372	4484	4564	4708	4868	5076	5268	3 x2	-
		6	4212	4292	4388	4452	4564	4644	4788	4948	5156	5348	3 x2	-
		7	4356	4436	4532	4596	4708	4788	4932	5092	5300	5492	3 x2	-
		8	4516	4596	4692	4756	4868	4948	5092	5252	5460	5652	3 x2	-
		9	4724	4804	4900	4964	5076	5156	5300	5460	5668	5860	3 x2	-
		10	4916	4996	5092	5156	5268	5348	5492	5652	5860	6052	3 x2	-

**DIMENSIONS**  
 Height: 460mm (18")  
 Width: 1340mm (52.75")  
 Depth: 1340mm (52.75")  
 Seat Height: 460mm (18")

Fabric Linear Yard Product Weight

# 90° External Seat

Single Fabric Two-Tone Option 1 Two-Tone Option 2

MYR/90/ES

MYR/90/ES/TT1

MYR/90/ES/TT2



MYR/90/ES	Fabric Grade Options	Band	COM / 1	2	3	4	5	6	7	8	9	10	(ly)	(lb)
		-	4848	4986	5152	5262	5456	5594	5842	6118	6476	6806	6	
	Two Tone 1 - TT1	-	Inner Fabric											
	Outer Fabric	COM / 1	4894	4976	5072	5138	5252	5332	5478	5642	5852	6048	3	
		2	4976	5056	5154	5218	5332	5414	5560	5722	5934	6128	3	
		3	5072	5154	5252	5316	5430	5512	5658	5820	6032	6226	3	
		4	5138	5218	5316	5382	5496	5576	5722	5886	6096	6292	3	
		5	5252	5332	5430	5496	5608	5690	5836	5998	6210	6406	3	
		6	5332	5414	5512	5576	5690	5772	5918	6080	6292	6486	3	
		7	5478	5560	5658	5722	5836	5918	6064	6226	6438	6632	3	
		8	5642	5722	5820	5886	5998	6080	6226	6388	6600	6796	3	
		9	5852	5934	6032	6096	6210	6292	6438	6600	6812	7006	3	
		10	6048	6128	6226	6292	6406	6486	6632	6796	7006	7202	3	
	Two Tone 2 - TT2	-	Seat Fabric											
	Back Fabric	COM / 1	4860	4948	5052	5122	5246	5332	5490	5666	5892	6102	4	
		2	4916	5004	5108	5178	5302	5388	5546	5722	5948	6158	4	
		3	4984	5072	5176	5246	5368	5456	5614	5788	6016	6226	4	
		4	5028	5116	5222	5292	5414	5502	5658	5834	6062	6272	4	
		5	5108	5196	5300	5370	5492	5580	5738	5912	6140	6350	4	
		6	5164	5252	5356	5426	5548	5636	5794	5968	6196	6406	4	
		7	5266	5352	5458	5528	5650	5738	5896	6070	6298	6508	4	
		8	5378	5466	5570	5640	5762	5850	6008	6182	6410	6620	4	
		9	5524	5612	5716	5786	5908	5996	6154	6328	6556	6766	4	
		10	5658	5746	5852	5922	6044	6132	6288	6464	6692	6902	4	

### DIMENSIONS

Height: 790mm (31")  
 Width: 1340mm (52.75")  
 Depth: 1340mm (52.75")  
 Seat Height: 460mm (18")

# 90° Internal Seat

Single Fabric Two-Tone Option 1 Two-Tone Option 2

MYR/90/IS

MYR/90/IS/TT1

MYR/90/IS/TT2



MYR/90/IS	Fabric Grade Options	Band	COM / 1	2	3	4	5	6	7	8	9	10	(ly)	(lb)
		-	5176	5340	5536	5666	5894	6058	6352	6678	7102	7492	7	
	Two Tone 1 - TT1	-	Inner Fabric											
	Outer Fabric	COM / 1	5188	5270	5366	5432	5546	5626	5774	5936	6146	6342	3	
		2	5276	5356	5454	5520	5634	5714	5860	6024	6234	6430	3	
		3	5380	5462	5560	5624	5738	5820	5966	6128	6340	6534	3	
		4	5450	5532	5630	5694	5808	5890	6036	6198	6410	6604	3	
		5	5574	5654	5752	5816	5930	6012	6158	6320	6532	6726	3	
		6	5660	5742	5840	5904	6018	6100	6246	6408	6620	6814	3	
		7	5818	5900	5996	6062	6176	6256	6404	6566	6776	6972	3	
		8	5994	6074	6172	6236	6350	6432	6578	6740	6952	7146	3	
		9	6220	6302	6400	6464	6578	6660	6806	6968	7180	7374	3	
		10	6430	6512	6610	6674	6788	6870	7016	7178	7390	7584	3	
	Two Tone 2 - TT2	-	Seat Fabric											
	Back Fabric	COM / 1	5188	5276	5380	5450	5574	5660	5818	5994	6220	6430	4	
		2	5270	5356	5462	5532	5654	5742	5900	6074	6302	6512	4	
		3	5366	5454	5560	5630	5752	5840	5996	6172	6400	6610	4	
		4	5432	5520	5624	5694	5816	5904	6062	6236	6464	6674	4	
		5	5546	5634	5738	5808	5930	6018	6176	6350	6578	6788	4	
		6	5626	5714	5820	5890	6012	6100	6256	6432	6660	6870	4	
		7	5774	5860	5966	6036	6158	6246	6404	6578	6806	7016	4	
		8	5936	6024	6128	6198	6320	6408	6566	6740	6968	7178	4	
		9	6146	6234	6340	6410	6532	6620	6776	6952	7180	7390	4	
		10	6342	6430	6534	6604	6726	6814	6972	7146	7374	7584	4	

### DIMENSIONS

Height: 790mm (31")  
 Width: 1340mm (52.75")  
 Depth: 1340mm (52.75")  
 Seat Height: 460mm (18")

Fabric Linear Yard Product Weight

# 120° without Back



MYR/120	Fabric Grade Options	Band	COM / 1										(ly)	(lb)
			2	3	4	5	6	7	8	9	10			
	Single Fabric	-	3866	3980	4116	4206	4364	4478	4682	4908	5202	5472	5	
	Two Tone 1 - TT1	-	IF - Inner Fabric											
	OF - Outer Fabric	COM / 1	3866	3936	4018	4074	4170	4238	4362	4500	4678	4844	3	
		2	3910	3980	4062	4116	4214	4282	4406	4544	4722	4886	3	
		3	3964	4032	4116	4170	4266	4334	4458	4596	4774	4940	3	
		4	3998	4066	4150	4206	4300	4370	4494	4630	4810	4974	3	
		5	4060	4128	4210	4266	4364	4430	4554	4692	4870	5036	3	
		6	4104	4172	4254	4310	4406	4478	4598	4736	4914	5080	3	
		7	4182	4250	4334	4388	4484	4554	4682	4814	4994	5158	3	
		8	4270	4338	4420	4476	4572	4640	4764	4908	5080	5246	3	
		9	4384	4452	4534	4590	4686	4754	4878	5016	5202	5360	3	
		10	4488	4556	4640	4694	4790	4860	4984	5120	5300	5472	3	

**DIMENSIONS**  
 Height: 460mm (18")  
 Width: 2120mm (83.5")  
 Depth: 670mm (26.5")  
 Seat Height: 460mm (18")

# 120° External Seat



MYR/120/ES	Fabric Grade Options	Band	COM / 1										(ly)	(lb)
			2	3	4	5	6	7	8	9	10			
	Single Fabric	-	4854	4986	5144	5250	5434	5566	5804	6068	6410	6726	5	
	Two Tone 1 - TT1	-	Inner Fabric											
	Outer Fabric	COM / 1	4866	4934	5018	5072	5168	5238	5362	5498	5678	5842	3	
		2	4934	5004	5086	5142	5238	5306	5430	5568	5746	5912	3	
		3	5018	5086	5168	5224	5320	5388	5512	5650	5828	5994	3	
		4	5072	5142	5224	5278	5374	5444	5568	5704	5884	6048	3	
		5	5168	5238	5320	5374	5472	5540	5664	5802	5980	6144	3	
		6	5238	5306	5388	5444	5540	5608	5732	5870	6048	6214	3	
		7	5362	5430	5512	5568	5664	5732	5856	5994	6172	6338	3	
		8	5498	5568	5650	5704	5802	5870	5994	6132	6310	6474	3	
		9	5678	5746	5828	5884	5980	6048	6172	6310	6488	6654	3	
		10	5842	5912	5994	6048	6144	6214	6338	6474	6654	6818	3	
	Two Tone 2 - TT2	-	Seat Fabric											
	Back Fabric	COM / 1	4832	4902	4984	5038	5134	5204	5328	5464	5644	5808	3	
		2	4882	4952	5034	5088	5184	5254	5378	5514	5694	5858	3	
		3	4942	5012	5094	5148	5244	5314	5438	5574	5754	5918	3	
		4	4982	5052	5134	5188	5284	5354	5478	5614	5794	5958	3	
		5	5052	5122	5204	5258	5354	5424	5548	5684	5864	6028	3	
		6	5102	5172	5254	5308	5404	5474	5598	5734	5914	6078	3	
		7	5192	5262	5344	5398	5494	5564	5688	5824	6004	6168	3	
		8	5292	5362	5444	5498	5594	5664	5788	5924	6104	6268	3	
		9	5422	5492	5574	5628	5724	5794	5918	6054	6234	6398	3	
		10	5542	5612	5694	5748	5844	5914	6038	6174	6354	6518	3	

**DIMENSIONS**  
 Height: 790mm (31")  
 Width: 2120mm (83.5")  
 Depth: 670mm (26.5")  
 Seat Height: 460mm (18")

MODULAR SEATING SYSTEMS

Fabric Linear Yard Product Weight

# 120° Internal Seat

Single Fabric

Two-Tone Option 1

Two-Tone Option 2

MYR/120/IS

MYR/120/IS/TT1

MYR/120/IS/TT2



## MYR/120/IS

Fabric Grade Options	Band	COM / 1	2	3	4	5	6	7	8	9	10	(ly)	(lb)
-	-	5030	5168	5334	5444	5638	5776	6024	6300	6658	6988	6	
Two Tone 1 - TT1	-	Inner Fabric											
Outer Fabric	COM / 1	5030	5100	5182	5238	5334	5402	5526	5664	5842	6008	3	
	2	5100	5168	5250	5306	5402	5470	5594	5732	5910	6076	3	
	3	5182	5250	5334	5388	5484	5554	5678	5814	5994	6158	3	
	4	5238	5306	5388	5444	5540	5608	5732	5870	6048	6214	3	
	5	5334	5402	5484	5540	5638	5704	5828	5966	6144	6310	3	
	6	5402	5470	5554	5608	5704	5776	5898	6034	6214	6378	3	
	7	5526	5594	5678	5732	5828	5898	6024	6158	6338	6502	3	
	8	5664	5732	5814	5870	5966	6034	6158	6300	6474	6640	3	
	9	5842	5910	5994	6048	6144	6214	6338	6474	6658	6818	3	
	10	6008	6076	6158	6214	6310	6378	6502	6640	6818	6988	3	
Two Tone 2 - TT2	-	Seat Fabric											
Back Fabric	COM / 1	5030	5100	5182	5238	5334	5402	5526	5664	5842	6008	3	
	2	5100	5168	5250	5306	5402	5470	5594	5732	5910	6076	3	
	3	5182	5250	5334	5388	5484	5554	5678	5814	5994	6158	3	
	4	5238	5306	5388	5444	5540	5608	5732	5870	6048	6214	3	
	5	5334	5402	5484	5540	5638	5704	5828	5966	6144	6310	3	
	6	5402	5470	5554	5608	5704	5776	5898	6034	6214	6378	3	
	7	5526	5594	5678	5732	5828	5898	6024	6158	6338	6502	3	
	8	5664	5732	5814	5870	5966	6034	6158	6300	6474	6640	3	
	9	5842	5910	5994	6048	6144	6214	6338	6474	6658	6818	3	
	10	6008	6076	6158	6214	6310	6378	6502	6640	6818	6988	3	

### DIMENSIONS

Height: 790mm (31")  
 Width: 2120mm (83.5")  
 Depth: 670mm (26.5")  
 Seat Height: 460mm (18")

Fabric Linear Yard Product Weight

## Myriad Options

LEG OPTIONS	CODE	DESCRIPTION	\$	
Cast Aluminum Tubular Steel Leg White Tubular Steel Leg Black Oak Lacquer	CAST ALUMINUM LEG	'B' OR 'W'	Black or white painted cast aluminum leg	No Upcharge
		POLISHED	Polished aluminum leg	No Upcharge
	STEEL LEG	'B' OR 'W'	Painted black or white tubular steel leg	No Upcharge
	OAK LEG - WHITE COLLAR		Oak lacquered leg with white painted collar	No Upcharge
	OTHER - PAINTED		Painted metal legs (or painted collar) in any standard Boss RAL Color See page 535 for a full list of colors available	70 per leg

MYR/CT/... MYRIAD COFFEE TABLES.	Code:	Description	Laminate Top	(lb)
	MYR/CT/W	Myriad Square Coffee Table - H13.5" x 26.5" (H345 x W670mm) Laminate top with White Painted Steel Legs	1380	-
	MYR/CT/B	Myriad Square Coffee Table - H13.5" x 26.5" (H345 x W670mm) Laminate top with Black Painted Steel Legs	1380	-
	MYR/CT/O	Myriad Square Coffee Table - H13.5" x 26.5" (H345 x W670mm) Laminate top with clear lacquered Oak Legs (Shown Left)	1380	-

# Huddle



MYR/HUDDLE	Fabric Grade Options	Band	COM / 1	2	3	4	5	6	7	8	9	10	(ly)	(lb)
3x MYR/2/B units 2x MYR/C/B units		-	17168	17572	18058	18380	18948	19352	20074	20878	21922	22884	-	-
	<b>Two Tone 1 - TT1</b>	-	<b>Inner Fabric</b>											
	<b>Outer Fabric</b>	COM / 1	17168	17456	17722	17896	18206	18422	18816	19256	19822	20346	-	-
		2	17456	17676	17936	18116	18422	18636	19036	19472	20036	20566	-	-
		3	17722	17936	18206	18376	18686	18906	19296	19736	20306	20826	-	-
		4	17896	18116	18376	18556	18856	19076	19472	19906	20476	21006	-	-
		5	18206	18422	18686	18856	19172	19386	19776	20216	20786	21306	-	-
		6	18422	18636	18906	19076	19386	19612	19996	20436	21006	21526	-	-
		7	18816	19036	19296	19472	19776	19996	20398	20826	21396	21922	-	-
		8	19256	19472	19736	19906	20216	20436	20826	21278	21836	22356	-	-
		9	19822	20036	20306	20476	20786	21006	21396	21836	22418	22926	-	-
		10	20346	20566	20826	21006	21306	21526	21922	22356	22926	23468	-	-
	<b>Two Tone 2 - TT2</b>	-	<b>Seat Fabric</b>											
	<b>Back Fabric</b>	COM / 1	17408	17744	18136	18402	18864	19196	19794	20456	21316	22114	-	-
		2	17612	17938	18336	18602	19064	19396	19994	20656	21516	22314	-	-
		3	17848	18180	18580	18842	19304	19636	20234	20892	21756	22550	-	-
		4	18006	18338	18740	19010	19468	19800	20392	21056	21920	22714	-	-
		5	18288	18620	19016	19282	19758	20076	20674	21338	22196	22990	-	-
		6	18488	18820	19216	19482	19944	20288	20874	21532	22396	23190	-	-
		7	18846	19178	19580	19846	20308	20640	21244	21896	22760	23554	-	-
		8	19250	19582	19974	20240	20708	21034	21632	22312	23154	23952	-	-
		9	19768	20100	20496	20762	21224	21556	22154	22812	23692	24470	-	-
		10	20248	20580	20978	21244	21706	22038	22630	23298	24158	24972	-	-

**DIMENSIONS**  
 Height: **790mm (31")**  
 Width: **2695mm (106")**  
 Depth: **2015mm (79.5")**  
 Seat Height: **460mm (18")**

Fabric Linear Yard Product Weight

MODULAR SEATING SYSTEMS

MYR/CT/... MYRIAD COFFEE TABLES.	Code:	Description	Laminate Top	(lb)
	<b>MYR/CT/W</b>	Myriad Square Coffee Table - H13.5" x 26.5" (H345 x W670mm) Laminate top with White Painted Steel Legs	1380	-
	<b>MYR/CT/B</b>	Myriad Square Coffee Table - H13.5" x 26.5" (H345 x W670mm) Laminate top with Black Painted Steel Legs	1380	-
	<b>MYR/CT/O</b>	Myriad Square Coffee Table - H13.5" x 26.5" (H345 x W670mm) Laminate top with clear lacquered Oak Legs (Shown Left)	1380	-



# Crescent



MYR/CRESCENT	Fabric Grade Options	Band	COM / 1	2	3	4	5	6	7	8	9	10	(ly)	(lb)
4x MYR/120/IS units		-	15090	15504	16002	16332	16914	17328	18072	18900	19974	20964	-	-
	<b>Two Tone 1 - TT1</b>	-	<b>Inner Fabric</b>											
	<b>Outer Fabric</b>	COM / 1	15090	15300	15546	15714	16002	16206	16578	16992	17526	18024	-	-
		2	15300	15504	15750	15918	16206	16410	16782	17196	17730	18228	-	-
		3	15546	15750	16002	16164	16452	16662	17034	17442	17982	18474	-	-
		4	15714	15918	16164	16332	16620	16824	17196	17610	18144	18642	-	-
		5	16002	16206	16452	16620	16914	17112	17484	17898	18432	18930	-	-
		6	16206	16410	16662	16824	17112	17328	17694	18102	18642	19134	-	-
		7	16578	16782	17034	17196	17484	17694	18072	18474	19014	19506	-	-
		8	16992	17196	17442	17610	17898	18102	18474	18900	19422	19920	-	-
		9	17526	17730	17982	18144	18432	18642	19014	19422	19974	20454	-	-
		10	18024	18228	18474	18642	18930	19134	19506	19920	20454	20964	-	-
	<b>Two Tone 2 - TT2</b>	-	<b>Seat Fabric</b>											
	<b>Back Fabric</b>	COM / 1	15090	15300	15546	15714	16002	16206	16578	16992	17526	18024	-	-
		2	15300	15504	15750	15918	16206	16410	16782	17196	17730	18228	-	-
		3	15546	15750	16002	16164	16452	16662	17034	17442	17982	18474	-	-
		4	15714	15918	16164	16332	16620	16824	17196	17610	18144	18642	-	-
		5	16002	16206	16452	16620	16914	17112	17484	17898	18432	18930	-	-
		6	16206	16410	16662	16824	17112	17328	17694	18102	18642	19134	-	-
		7	16578	16782	17034	17196	17484	17694	18072	18474	19014	19506	-	-
		8	16992	17196	17442	17610	17898	18102	18474	18900	19422	19920	-	-
		9	17526	17730	17982	18144	18432	18642	19014	19422	19974	20454	-	-
		10	18024	18228	18474	18642	18930	19134	19506	19920	20454	20964	-	-

**DIMENSIONS**

Height: **790mm (31")**  
 Width: **3690mm (145.25")**  
 Depth: **2125mm (83.5")**  
 Seat Height: **460mm (18")**

Fabric Linear Yard Product Weight

MYR/CT/... MYRIAD COFFEE TABLES.	Code:	Description	Laminate Top	(lb)
	<b>MYR/CT/W</b>	Myriad Square Coffee Table - H13.5" x 26.5" (H345 x W670mm) Laminate top with White Painted Steel Legs	1380	-
	<b>MYR/CT/B</b>	Myriad Square Coffee Table - H13.5" x 26.5" (H345 x W670mm) Laminate top with Black Painted Steel Legs	1380	-
	<b>MYR/CT/O</b>	Myriad Square Coffee Table - H13.5" x 26.5" (H345 x W670mm) Laminate top with clear lacquered Oak Legs (Shown Left)	1380	-



# Propeller



MYR/PROPELLER	Fabric Grade Options	Band	COM / 1 2 3 4 5 6 7 8 9 10										(ly)	(lb)	
3x MYR/120/IS units			-	15090	15504	16002	16332	16914	17328	18072	18900	19974	20964	-	-
<b>Two Tone 1 - TT1</b>			-	<b>Inner Fabric</b>											
<b>Outer Fabric</b>			COM /1	15090	15300	15546	15714	16002	16206	16578	16992	17526	18024	-	-
			2	15300	15504	15750	15918	16206	16410	16782	17196	17730	18228	-	-
			3	15546	15750	16002	16164	16452	16662	17034	17442	17982	18474	-	-
			4	15714	15918	16164	16332	16620	16824	17196	17610	18144	18642	-	-
			5	16002	16206	16452	16620	16914	17112	17484	17898	18432	18930	-	-
			6	16206	16410	16662	16824	17112	17328	17694	18102	18642	19134	-	-
			7	16578	16782	17034	17196	17484	17694	18072	18474	19014	19506	-	-
			8	16992	17196	17442	17610	17898	18102	18474	18900	19422	19920	-	-
			9	17526	17730	17982	18144	18432	18642	19014	19422	19974	20454	-	-
			10	18024	18228	18474	18642	18930	19134	19506	19920	20454	20964	-	-
<b>Two Tone 2 - TT2</b>			-	<b>Seat Fabric</b>											
<b>Back Fabric</b>			COM /1	15090	15300	15546	15714	16002	16206	16578	16992	17526	18024	-	-
			2	15300	15504	15750	15918	16206	16410	16782	17196	17730	18228	-	-
			3	15546	15750	16002	16164	16452	16662	17034	17442	17982	18474	-	-
			4	15714	15918	16164	16332	16620	16824	17196	17610	18144	18642	-	-
			5	16002	16206	16452	16620	16914	17112	17484	17898	18432	18930	-	-
			6	16206	16410	16662	16824	17112	17328	17694	18102	18642	19134	-	-
			7	16578	16782	17034	17196	17484	17694	18072	18474	19014	19506	-	-
			8	16992	17196	17442	17610	17898	18102	18474	18900	19422	19920	-	-
			9	17526	17730	17982	18144	18432	18642	19014	19422	19974	20454	-	-
			10	18024	18228	18474	18642	18930	19134	19506	19920	20454	20964	-	-

**DIMENSIONS**  
 Height: 790mm (31")  
 Width: 2140mm (84.25")  
 Depth: 2430mm (95.75")  
 Seat Height: 460mm (18")

Fabric Linear Yard Product Weight

MODULAR SEATING SYSTEMS

MYR/CT/... MYRIAD COFFEE TABLES.	Code:	Description	Laminate Top	(lb)
	MYR/CT/W	Myriad Square Coffee Table - H13.5" x 26.5" (H345 x W670mm) Laminate top with White Painted Steel Legs	1380	-
	MYR/CT/B	Myriad Square Coffee Table - H13.5" x 26.5" (H345 x W670mm) Laminate top with Black Painted Steel Legs	1380	-
	MYR/CT/O	Myriad Square Coffee Table - H13.5" x 26.5" (H345 x W670mm) Laminate top with clear lacquered Oak Legs (Shown Left)	1380	-



# Cruciform



MYR/CRUCIFORM	Fabric Grade Options	Band	COM / 1	2	3	4	5	6	7	8	9	10	(ly)	(lb)
		-	20704	21360	22144	22664	23576	24232	25408	26712	28408	29968	-	-
	<b>Two Tone 1 - TT1</b>	-	<b>Inner Fabric</b>											
	<b>Outer Fabric</b>	COM / 1	20752	21080	21464	21728	22184	22504	23096	23744	24584	25368	-	-
		2	21104	21424	21816	22080	22536	22856	23440	24096	24936	25720	-	-
		3	21520	21848	22240	22496	22952	23280	23864	24512	25360	26136	-	-
		4	21800	22128	22520	22776	23232	23560	24144	24792	25640	26416	-	-
		5	22296	22616	23008	23264	23720	24048	24632	25280	26128	26904	-	-
		6	22640	22968	23360	23616	24072	24400	24984	25632	26480	27256	-	-
		7	23272	23600	23984	24248	24704	25024	25616	26264	27104	27888	-	-
		8	23976	24296	24688	24944	25400	25728	26312	26960	27808	28584	-	-
		9	24880	25208	25600	25856	26312	26640	27224	27872	28720	29496	-	-
		10	25720	26048	26440	26696	27152	27480	28064	28712	29560	30336	-	-
	<b>Two Tone 2 - TT2</b>	-	<b>Seat Fabric</b>											
	<b>Back Fabric</b>	COM / 1	20752	21080	21464	21728	22184	22504	23096	23744	24584	25368	-	-
		2	21104	21424	21816	22080	22536	22856	23440	24096	24936	25720	-	-
		3	21520	21848	22240	22496	22952	23280	23864	24512	25360	26136	-	-
		4	21800	22128	22520	22776	23232	23560	24144	24792	25640	26416	-	-
		5	22296	22616	23008	23264	23720	24048	24632	25280	26128	26904	-	-
		6	22640	22968	23360	23616	24072	24400	24984	25632	26480	27256	-	-
		7	23272	23600	23984	24248	24704	25024	25616	26264	27104	27888	-	-
		8	23976	24296	24688	24944	25400	25728	26312	26960	27808	28584	-	-
		9	24880	25208	25600	25856	26312	26640	27224	27872	28720	29496	-	-
		10	25720	26048	26440	26696	27152	27480	28064	28712	29560	30336	-	-

**DIMENSIONS**

Height: **790mm (31")**  
 Width: **2690mm (106")**  
 Depth: **2690mm (106")**  
 Seat Height: **460mm (18")**

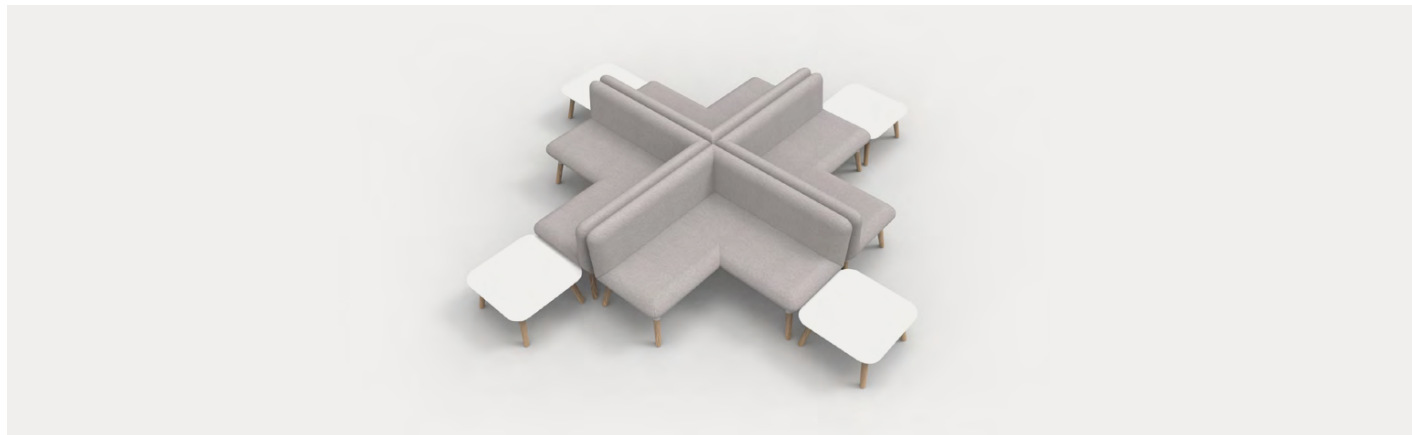

Fabric Linear Yard Product Weight

MYR/CT/... MYRIAD COFFEE TABLES.	Code:	Description	Laminate Top	(lb)
	<b>MYR/CT/W</b>	Myriad Square Coffee Table - H13.5" x 26.5" (H345 x W670mm) Laminate top with White Painted Steel Legs	1380	-
	<b>MYR/CT/B</b>	Myriad Square Coffee Table - H13.5" x 26.5" (H345 x W670mm) Laminate top with Black Painted Steel Legs	1380	-
	<b>MYR/CT/O</b>	Myriad Square Coffee Table - H13.5" x 26.5" (H345 x W670mm) Laminate top with clear lacquered Oak Legs (Shown Left)	1380	-

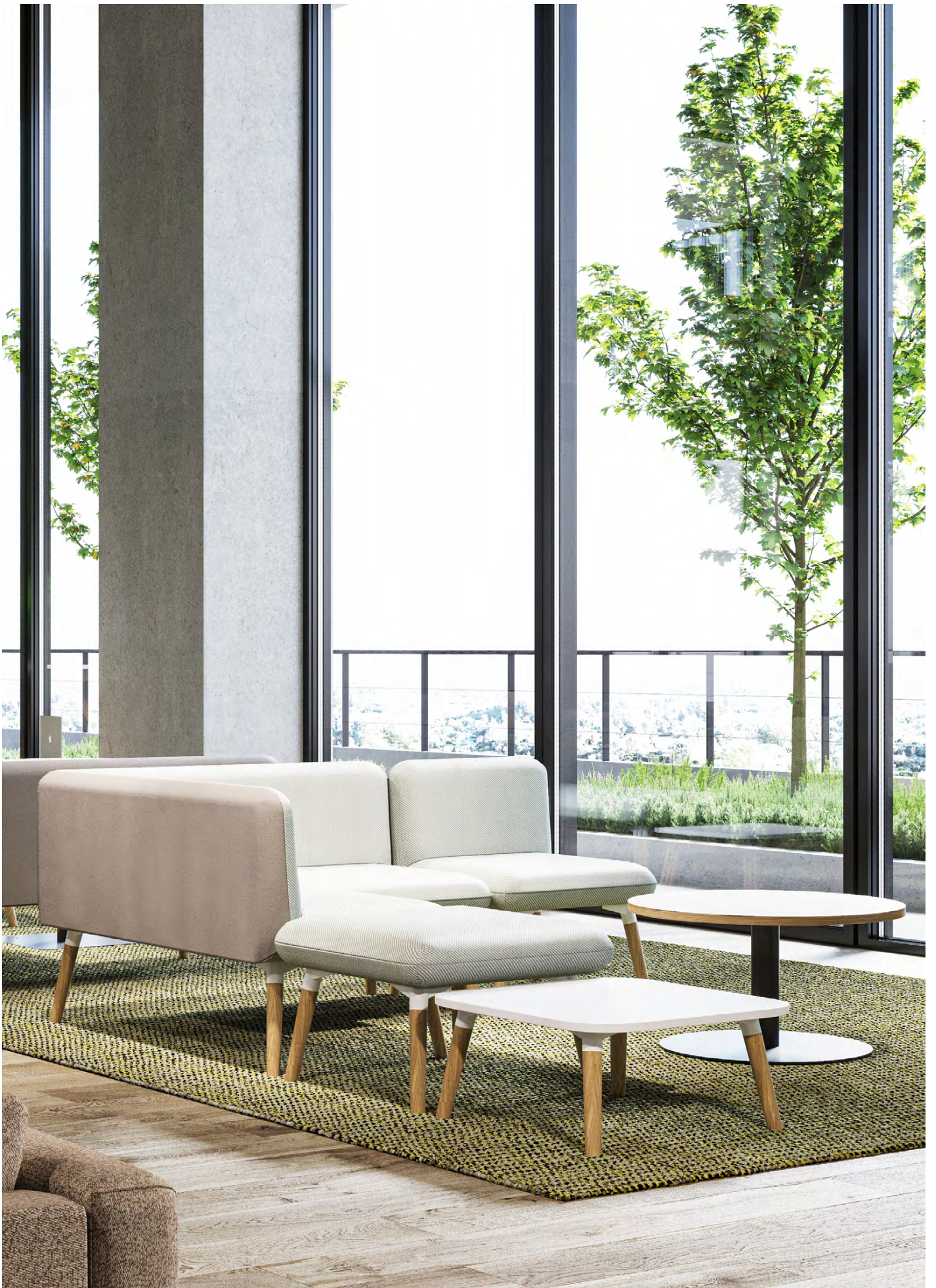







MODULAR SEATING SYSTEMS

MYR/S... MYRIAD SCREENS.	Fabric Grade Options	Band	COM /1	2	3	4	5	6	7	8	9	10	(ly)	(lb)
2	1078	1122	1174	1210	1272	1314	1394	1482	1594	1700	2 x2			
3	1132	1174	1228	1262	1324	1368	1446	1534	1648	1752	2 x2			
4	1166	1210	1262	1298	1358	1402	1482	1568	1682	1788	2 x2			
5	1228	1272	1324	1358	1422	1464	1542	1630	1744	1848	2 x2			
6	1272	1314	1368	1402	1464	1510	1586	1674	1788	1892	2 x2			
7	1350	1394	1446	1482	1542	1586	1668	1752	1866	1972	2 x2			
8	1438	1482	1534	1568	1630	1674	1752	1844	1954	2058	2 x2			
9	1552	1594	1648	1682	1744	1788	1866	1954	2072	2172	2 x2			
10	1656	1700	1752	1788	1848	1892	1972	2058	2172	2282	2 x2			
<b>MYR/S2</b> High Single Screen H55" x 26.5" (H1400mm x W670mm) with black or white painted feet.  <b>DIMENSIONS</b> Height: <b>1400mm (55")</b> Width: <b>670mm (26.5")</b> Depth: <b>25mm (1")</b>	Single OR Two Tone (Front/Back)	COM /1	910	936	966	986	1020	1046	1090	1140	1206	1266	1 x2	
		2	936	960	990	1010	1046	1070	1116	1166	1230	1290	1 x2	
		3	966	990	1020	1040	1076	1100	1146	1196	1260	1320	1 x2	
		4	986	1010	1040	1060	1096	1120	1166	1216	1280	1340	1 x2	
		5	1020	1046	1076	1096	1130	1156	1200	1250	1316	1376	1 x2	
		6	1046	1070	1100	1120	1156	1180	1226	1276	1340	1400	1 x2	
		7	1090	1116	1146	1166	1200	1226	1270	1320	1386	1446	1 x2	
		8	1140	1166	1196	1216	1250	1276	1320	1370	1436	1496	1 x2	
		9	1206	1230	1260	1280	1316	1340	1386	1436	1500	1560	1 x2	
		10	1266	1290	1320	1340	1376	1400	1446	1496	1560	1620	1 x2	
<b>MYR/S3</b> Low Double Screen H43" x 52.75" (H1090mm x W1340mm) with black or white painted feet.  <b>DIMENSIONS</b> Height: <b>1090mm (43")</b> Width: <b>1340mm (52.75")</b> Thickness: <b>25mm (1")</b>	Single OR Two Tone (Front/Back)	COM /1	946	984	1030	1060	1112	1150	1216	1292	1390	1480	2 x2	
		2	984	1022	1066	1096	1150	1186	1254	1330	1426	1516	2 x2	
		3	1030	1066	1112	1142	1194	1232	1300	1374	1472	1562	2 x2	
		4	1060	1096	1142	1172	1224	1262	1330	1404	1502	1592	2 x2	
		5	1112	1150	1194	1224	1278	1314	1382	1456	1554	1644	2 x2	
		6	1150	1186	1232	1262	1314	1354	1420	1494	1592	1682	2 x2	
		7	1216	1254	1300	1330	1382	1420	1490	1562	1660	1750	2 x2	
		8	1292	1330	1374	1404	1456	1494	1562	1640	1734	1824	2 x2	
		9	1390	1426	1472	1502	1554	1592	1660	1734	1836	1922	2 x2	
		10	1480	1516	1562	1592	1644	1682	1750	1824	1922	2016	2 x2	



MYR/A/TAB... MYRIAD LINKING TABLES.	Code:	Cost Per Unit (\$)		(lb)
		Laminate Top Finish	Veneer Top Finish	
<b>MYR/A/TAB/...</b> Linking Table 	<b>MYR/A/TAB/PLEC</b>	490	POA	-
	<b>MYR/A/TAB/OV</b>	490	POA	-
Linking plate to link seating units. One required per end, per unit. <b>Price PER PLATE</b>	<b>LINKING PLATE</b>	68 Per linking plate		-

**MYR/A...  
ARM UNITS**

	Fabric Grade Options	Band	COM / 1	2	3	4	5	6	7	8	9	10	(ly)	(lb)	
<p><b>MYR/A</b></p> <p>Upholstered arm with linking support bracket, no power.</p>  <p><b>DIMENSIONS (ARM PAD)</b> Pad Height: <b>85mm (3.5")</b> Pad Width: <b>220mm (8.5")</b> Pad Depth: <b>440mm (17.5")</b></p>	Single Fabric	-	802	840	886	916	970	1008	1076	1152	1250	1340	2		
	Two Tone 1	-	<b>Top</b>												
	Bottom	COM / 1		802	822	844	860	886	904	938	976	1024	1070	1	
		2		822	840	862	878	904	922	956	994	1042	1088	1	
		3		844	862	886	900	926	946	980	1016	1066	1110	1	
		4		860	878	900	916	942	960	994	1032	1080	1126	1	
		5		886	904	926	942	970	986	1020	1058	1106	1152	1	
		6		904	922	946	960	986	1008	1040	1076	1126	1170	1	
		7		938	956	980	994	1020	1040	1076	1110	1160	1204	1	
		8		976	994	1016	1032	1058	1076	1110	1152	1196	1242	1	
9		1024	1042	1066	1080	1106	1126	1160	1196	1250	1290	1			
10		1070	1088	1110	1126	1152	1170	1204	1242	1290	1340	1			
<p><b>MYR/A/PIX1</b></p> <p>Upholstered arm with linking support bracket, 1x White Pixel 1x power and 1x TUF with a 10' (3m) starter lead.</p>  <p><b>DIMENSIONS (ARM PAD)</b> Pad Height: <b>85mm (3.5")</b> Pad Width: <b>220mm (8.5")</b> Pad Depth: <b>440mm (17.5")</b></p>	Single Fabric	-	1126	1164	1210	1240	1294	1332	1400	1476	1574	1664	2		
	Two Tone 1	-	<b>Top</b>												
	Bottom	COM / 1		1126	1146	1168	1184	1210	1228	1262	1300	1348	1394	1	
		2		1146	1164	1186	1202	1228	1246	1280	1318	1366	1412	1	
		3		1168	1186	1210	1224	1250	1270	1304	1340	1390	1434	1	
		4		1184	1202	1224	1240	1266	1284	1318	1356	1404	1450	1	
		5		1210	1228	1250	1266	1294	1310	1344	1382	1430	1476	1	
		6		1228	1246	1270	1284	1310	1332	1364	1400	1450	1494	1	
		7		1262	1280	1304	1318	1344	1364	1400	1434	1484	1528	1	
		8		1300	1318	1340	1356	1382	1400	1434	1476	1520	1566	1	
9		1348	1366	1390	1404	1430	1450	1484	1520	1574	1614	1			
10		1394	1412	1434	1450	1476	1494	1528	1566	1614	1664	1			
<p><b>MYR/A/PIX2</b></p> <p>Upholstered arm with linking support bracket 2x White Pixel units, 1x power and 2x TUF with a 10' (3m) starter lead.</p>  <p><b>DIMENSIONS (ARM PAD)</b> Pad Height: <b>85mm (3.5")</b> Pad Width: <b>220mm (8.5")</b> Pad Depth: <b>440mm (17.5")</b></p>	Single Fabric	-	1738	1776	1822	1852	1906	1944	2012	2088	2186	2276	2		
	Two Tone 1	-	<b>Top</b>												
	Bottom	COM / 1		1738	1758	1780	1796	1822	1840	1874	1912	1960	2006	1	
		2		1758	1776	1798	1814	1840	1858	1892	1930	1978	2024	1	
		3		1780	1798	1822	1836	1862	1882	1916	1952	2002	2046	1	
		4		1796	1814	1836	1852	1878	1896	1930	1968	2016	2062	1	
		5		1822	1840	1862	1878	1906	1922	1956	1994	2042	2088	1	
		6		1840	1858	1882	1896	1922	1944	1976	2012	2062	2106	1	
		7		1874	1892	1916	1930	1956	1976	2012	2046	2096	2140	1	
		8		1912	1930	1952	1968	1994	2012	2046	2088	2132	2178	1	
9		1960	1978	2002	2016	2042	2062	2096	2132	2186	2226	1			
10		2006	2024	2046	2062	2088	2106	2140	2178	2226	2276	1			
<p><b>END ARM UNIT MYR/EA/LH OR MYR/EA/RH (PER ARM).</b></p> <p>Upholstered end arm available in RH or LH configurations. Also Available with Power</p>  <p><b>DIMENSIONS</b> Height: <b>220mm (8.5")</b> Width: <b>85mm (3.5")</b> Depth: <b>440mm (17.5")</b></p>	Single Fabric	-	604	642	688	718	772	810	878	954	1052	1142	2		
	Two Tone 1	-	<b>Top</b>												
	Bottom	COM / 1		604	624	646	662	688	706	740	778	826	872	1	
		2		624	642	664	680	706	724	758	796	844	890	1	
		3		646	664	688	702	728	748	782	818	868	912	1	
		4		662	680	702	718	744	762	796	834	882	928	1	
		5		688	706	728	744	772	788	822	860	908	954	1	
		6		706	724	748	762	788	810	842	878	928	972	1	
		7		740	758	782	796	822	842	878	912	962	1006	1	
		8		778	796	818	834	860	878	912	954	998	1044	1	
9		826	844	868	882	908	928	962	998	1052	1092	1			
10		872	890	912	928	954	972	1006	1044	1092	1142	1			



To view the 2D line drawings for the options shown here, please scan or click this QR code

 Fabric Linear Yard  Product Weight



# Raft

Modular Seating Systems

boss



Raft is a modular system available in a variety of configurations allowing you to create the seating solution you need. Designed with agile working in mind, Raft modules include single and double benches, corner pieces and curved sections. Optional integrated power and data further establish this as the flexible seat for the flexible worker.

- Curve and corner units available
- Individual polished legs
- CMHR foam
- Optional arms
- Optional back
- Optional braked castors
- Optional linking mechanism
- Optional power and data available
- When specifying backs and arms on the Raft collection products are described from the perspective of 'as you sit' rather than as you view.



MODULAR SEATING SYSTEMS

# Raft

Modular Seating Systems

boss

RAFT/1 RAFT 1 SEAT UNITS	Code:	Description	COM													COL	L1	L2	L3	(ly) (ft²) (lb)
			/1	2	3	4	5	6	7	8	9	10	11	12	13					
	<b>RAFT1</b>	Raft single seat bench no back no arms	986	1036	1096	1136	1206	1256	1346	1446	1576	1696	1048	1544	1848	2776	2	32	-	
	<b>RAFT1 FB</b>	Raft single seat bench full back no arms	1404	1480	1570	1630	1736	1812	1948	2098	2294	2474	1496	2334	2846	4412	3	54	-	
	<b>RAFT1 FB LA</b>	Raft single seat bench full back left arm	1748	1848	1968	2048	2188	2288	2468	2668	2928	3168	1868	3062	3794	6026	4	77	-	
	<b>RAFT1 FB RA</b>	Raft single seat bench full back right arm	1748	1848	1968	2048	2188	2288	2468	2668	2928	3168	1868	3062	3794	6026	4	77	-	
	<b>RAFT1 FBA</b>	Raft single seat bench full back two arms	2080	2206	2356	2456	2632	2758	2984	3234	3560	3860	2230	3626	4480	7090	5	90	-	
	<b>RAFT1 BC</b>	Raft single seat corner unit full back	1730	1806	1896	1956	2062	2138	2274	2424	2620	2800	1826	2742	3302	5012	3	59	-	
	<b>RAFT1 45</b>	Raft single 45 degree curve unit no back	1290	1354	1430	1480	1568	1632	1746	1872	2036	2186	1368	2066	2494	3798	3	45	-	
	<b>RAFT1 45 FB</b>	Raft single 45 degree curve unit full back	1802	1878	1968	2028	2134	2210	2346	2496	2692	2872	1898	2596	3024	4328	3	45	-	
	<b>RAFT 180</b>	Raft 180 degree bench no back no arms	1718	1794	1884	1944	2050	2126	2262	2412	2608	2788	1812	2510	2938	4242	3	45	-	
	<b>RAFT 90</b>	Raft 90 degree bench no back no arms	1128	1178	1238	1278	1348	1398	1488	1588	1718	1838	1190	1748	2090	3134	2	36	-	
	<b>RAFT 45</b>	Raft 45 degree bench no back no arms	1066	1116	1176	1216	1286	1336	1426	1526	1656	1776	1128	1686	2028	3072	2	36	-	

**DIMENSIONS**

Height: **740mm (29")**  
 Depth: **670mm (26.25")**  
 Seat Height: **450mm (17.75")**  
 Seat Depth: **510mm (20")**  
 Arm Height: **740mm (29")**





**Widths:**

RAFT T1: **670mm (26.25")**  
 RAFT T1 - 1 Arm: **820mm (32")**  
 RAFT T1 - 2 Arm: **970mm (38")**  
 RAFT T1 BC: **670mm (26.25")**  
 RAFT T1 45: **1120mm (44")**  
 RAFT 180: **1340mm (52.75")**  
 RAFT 90: **670mm (26.25")**  
 RAFT 45: **670mm (26.25")**

RAFT T2: **1340mm (52.75")**  
 RAFT T2 - 1 Arm: **1490mm (58.5")**  
 RAFT T2 - 2 Arm: **1640mm (64.5")**



**RAFT/2**  
**RAFT 2 SEAT UNITS**

	Code:	Description	COM /1	2	3	4	5	6	7	8	9	10	COL	L1	L2	L3	(ly)	(ft²)	(lb)
	<b>RAFT2</b>	Raft two seat bench no back no arms	1504	1580	1670	1730	1836	1912	2048	2198	2394	2574	1596	2294	2722	4026	3	45	-
	<b>RAFT2 FBA</b>	Raft two seat bench full back two arms	2750	2926	3136	3276	3522	3698	4014	4364	4820	5240	2956	4770	5882	9274	7	117	-
	<b>RAFT2 FB RA</b>	Raft two seat bench full back right arm	2444	2594	2774	2894	3104	3254	3524	3824	4214	4574	2620	4294	5320	8452	6	108	-
	<b>RAFT2 FB LA</b>	Raft two seat bench full back left arm	2444	2594	2774	2894	3104	3254	3524	3824	4214	4574	2620	4294	5320	8452	6	108	-
	<b>RAFT2 FB</b>	Raft two seat bench full back no arms	2074	2200	2350	2450	2626	2752	2978	3228	3554	3854	2222	3478	4248	6596	5	81	-
	<b>RAFT2 RB RA</b>	Raft two seat bench right back right arm	2288	2414	2564	2664	2840	2966	3192	3442	3768	4068	2440	3836	4690	7300	5	90	-
	<b>RAFT2 LB LA</b>	Raft two seat bench left back left arm	2288	2414	2564	2664	2840	2966	3192	3442	3768	4068	2440	3836	4690	7300	5	90	-
	<b>RAFT2 LB</b>	Raft two seat bench left back no arm	1938	2038	2158	2238	2378	2478	2658	2858	3118	3358	2060	3038	3636	5462	4	63	-
	<b>RAFT2 RB</b>	Raft two seat bench right back no arm	1938	2038	2158	2238	2378	2478	2658	2858	3118	3358	2060	3038	3636	5462	4	63	-

MODULAR SEATING SYSTEMS

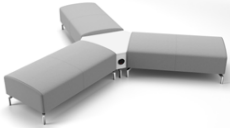
	<b>RAFT T1</b>	Square Corner table	1138	1164	1194	1214	1250	1276	1322	1372	1438	1498	1176	1456	1626	2148	1	18	-
	<b>RAFT T2</b>	Rectangular table	1620	1670	1730	1770	1840	1890	1980	2080	2210	2330	1688	2246	2588	3632	2	36	-
	<b>RAFT T3</b>	Triangular table	1344	1370	1400	1420	1456	1482	1528	1578	1644	1704	1384	1664	1834	2356	1	18	-

N.B. Leather is a natural material which will crease and 'puddle'. When specifying backs and arms products are described from a sitted perspective - not as its viewed.

 Fabric Linear Yard  Leather Square Footage  Product Weight

**Product Certification**  
BS EN 15373: 2007, Level 2

**Options**

CODE:	DESCRIPTION	\$
<b>SIFFIX C</b>	Set of 4 braked castors	370
<b>SUFFIX LM</b>	Set of two linking mechanisms (supplied separately)	110

**Painted Leg Options**

Colour Choice	RAL 9005	RAL 9016	RAL 060 60 05	RAL 240 20 22	RAL 220 70 10	RAL 130 30 20	RAL 040 50 50	RAL 070 70 80
Suffix*	PF/B	PF/W	PF/SG	PF/DB	PF/LB	PF/GN	PF/CR	PF/Y
\$	POA	POA	POA	POA	POA	POA	POA	POA

# Raft Plus

Modular Seating Systems

boss





Raft Plus is a modular system offering endless configuration possibilities. Raft Plus breathes life into office and hospitality settings, giving you the power to control and style your space.

### Raft+ Units

The Raft+ family consists of eight units that can be arranged to create configurations.

These units are available as a mid-back or high-back.

Raft Plus is available on metal legs



Mid Back



High Back

### Raft Plus - Configurations

Raft Plus is available to specify in an almost unlimited variety of combinations, however we have priced two of the most common configs for you.

Linking clips are available separately.

Reef tables are shown on the image examples.



### Power & data units

Pixel power and data units are available to specify and can be fitted to the Raft seating range in multiple areas.

Our Standard power offering for Raft Plus is:

Pixel - 1x Power & 1x TUF A+C



Pixel  
1x Power +TUF

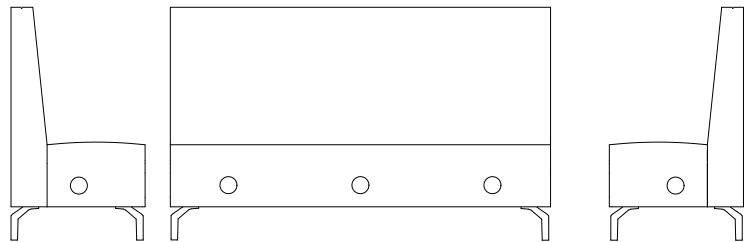

**Not recommended to be upholstered in Grade 1 fabrics**



# Raft Plus - Line drawings

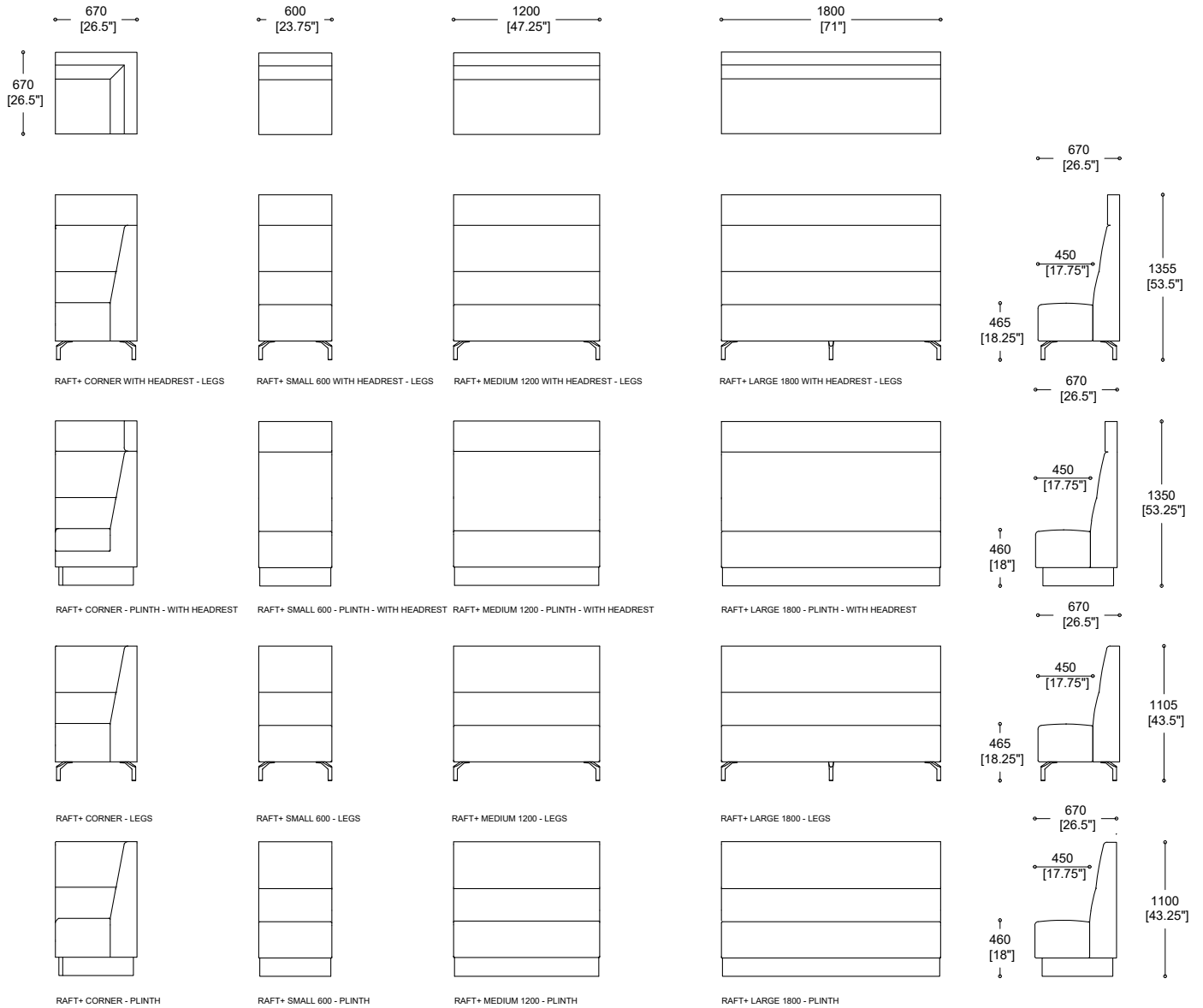

MODULAR SEATING SYSTEMS

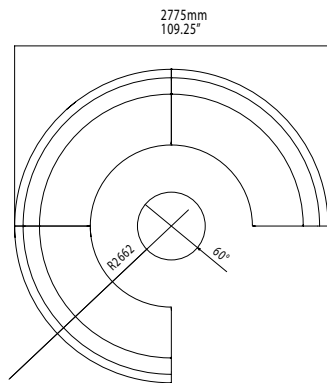

R+/CONFIG/1

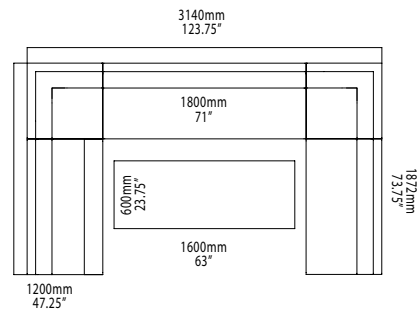

R+/CONFIG/2

<b>RAFT PLUS</b> R+...	<b>Code:</b>	<b>Description</b>	<b>COM /1</b>	<b>2</b>	<b>3</b>	<b>4</b>	<b>5</b>	<b>6</b>	<b>7</b>	<b>8</b>	<b>9</b>	<b>10</b>	(ly)	(lb)
	<b>R+/1</b>	23.5" (600mm) wide unit	1920	2008	2114	2184	2308	2396	2554	2730	2958	3168	3.50	-
		Lumbar panel to above	340	372	410	436	480	512	570	634	716	792	1.25	-
		<b>TOTAL</b>	<b>2260</b>	<b>2380</b>	<b>2524</b>	<b>2620</b>	<b>2788</b>	<b>2908</b>	<b>3124</b>	<b>3364</b>	<b>3674</b>	<b>3960</b>	<b>4.75</b>	-
		Optional 11.75" (300mm) High-back rest	678	710	748	774	818	850	908	972	1054	1130	1.25	-
	<b>R+/2</b>	47.25" (1200mm) wide unit	3726	3864	4030	4140	4334	4472	4720	4996	5354	5684	5.50	-
		Lumbar panel to above	660	692	730	756	800	832	890	954	1036	1112	1.25	-
		<b>TOTAL</b>	<b>4386</b>	<b>4556</b>	<b>4760</b>	<b>4896</b>	<b>5134</b>	<b>5304</b>	<b>5610</b>	<b>5950</b>	<b>6390</b>	<b>6796</b>	<b>6.75</b>	-
		Optional 11.75" (300mm) High-back rest	1288	1320	1358	1384	1428	1460	1518	1582	1664	1740	1.25	-
	<b>R+/3</b>	70.75" (1800mm) wide unit	4124	4294	4498	4634	4872	5042	5346	5684	6124	6530	6.75	-
		Lumbar panel to above	728	786	854	900	980	1038	1140	1254	1402	1538	2.25	-
		<b>TOTAL</b>	<b>4852</b>	<b>5080</b>	<b>5352</b>	<b>5534</b>	<b>5852</b>	<b>6080</b>	<b>6486</b>	<b>6938</b>	<b>7526</b>	<b>8068</b>	<b>9.00</b>	-
		Optional 11.75" (300mm) High-back rest	1444	1476	1514	1540	1584	1616	1674	1738	1820	1896	1.25	-
	<b>R+/C</b>	Corner unit	2958	3072	3208	3298	3456	3570	3774	4000	4294	4564	4.50	-
		Lumbar panel to above	524	556	594	620	664	696	754	818	900	976	1.25	-
		<b>TOTAL</b>	<b>3482</b>	<b>3628</b>	<b>3802</b>	<b>3918</b>	<b>4120</b>	<b>4266</b>	<b>4528</b>	<b>4818</b>	<b>5194</b>	<b>5540</b>	<b>5.75</b>	-
		Optional 11.75" (300mm) High-back rest	1266	1298	1336	1362	1406	1438	1496	1560	1642	1718	1.25	-
	<b>R+/30/IF</b>	30 degree unit	2018	2106	2212	2282	2406	2494	2652	2828	3056	3266	3.50	-
		Lumbar panel to above	358	390	428	454	498	530	588	652	734	810	1.25	-
		<b>TOTAL</b>	<b>2376</b>	<b>2496</b>	<b>2640</b>	<b>2736</b>	<b>2904</b>	<b>3024</b>	<b>3240</b>	<b>3480</b>	<b>3790</b>	<b>4076</b>	<b>4.75</b>	-
		Optional 11.75" (300mm) High-back rest	600	620	644	660	688	708	742	780	830	876	0.75	-
	<b>R+/45/IF</b>	45 degree unit	2726	2840	2976	3066	3224	3338	3542	3768	4062	4332	4.50	-
		Lumbar panel to above	484	516	554	580	624	656	714	778	860	936	1.25	-
		<b>TOTAL</b>	<b>3210</b>	<b>3356</b>	<b>3530</b>	<b>3646</b>	<b>3848</b>	<b>3994</b>	<b>4256</b>	<b>4546</b>	<b>4922</b>	<b>5268</b>	<b>5.75</b>	-
		Optional 11.75" (300mm) High-back rest	816	836	860	876	904	924	958	996	1046	1092	0.75	-
	<b>R+/60/IF</b>	60 degree unit	3740	3878	4044	4154	4348	4486	4734	5010	5368	5698	5.50	-
		Lumbar panel to above	664	722	790	836	916	974	1076	1190	1338	1474	2.25	-
		<b>TOTAL</b>	<b>4404</b>	<b>4600</b>	<b>4834</b>	<b>4990</b>	<b>5264</b>	<b>5460</b>	<b>5810</b>	<b>6200</b>	<b>6706</b>	<b>7172</b>	<b>7.75</b>	-
		Optional 11.75" (300mm) High-back rest	1058	1078	1102	1118	1146	1166	1200	1238	1288	1334	0.75	-
	<b>R+/90/IF</b>	90 degree unit	4718	4912	5146	5302	5574	5768	6118	6506	7010	7476	7.75	-
		Lumbar panel to above	834	892	960	1006	1086	1144	1246	1360	1508	1644	2.25	-
		<b>TOTAL</b>	<b>5552</b>	<b>5804</b>	<b>6106</b>	<b>6308</b>	<b>6660</b>	<b>6912</b>	<b>7364</b>	<b>7866</b>	<b>8518</b>	<b>9120</b>	<b>10.00</b>	-
		Optional 11.75" (300mm) High-back rest	1306	1326	1350	1366	1394	1414	1448	1486	1536	1582	0.75	-

**RAFT PLUS**  
R+/-...

**Code:**

**Description**

**COM /1**

**2**

**3**

**4**

**5**

**6**

**7**

**8**

**9**

**10**

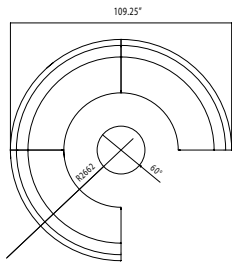

3 x 90 degree inward facing units

14154 14736 15438 15906 16722 17304 18354 19518 21030 22428

23.25 -

Lumbar panel to above

2502 2676 2880 3018 3258 3432 3738 4080 4524 4932

6.75 -

Linking Clips

110 110 110 110 110 110 110 110 110 110

- -

**TOTAL 16766 17522 18428 19034 20090 20846 22202 23708 25664 27470**

**30.00 -**

Optional 11.75" (300mm) High-back rest

3918 3978 4050 4098 4182 4242 4344 4458 4608 4746

2.25 -

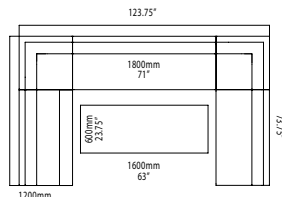

2 x Medium units, 2 x Corner unit & 1 x Large unit

17492 18166 18974 19510 20452 21126 22334 23676 25420 27026

26.75 -

Lumbar panel to above

3096 3282 3502 3652 3908 4094 4428 4798 5274 5714

7.25 -

Linking Clips

398 398 398 398 398 398 398 398 398 398

- -

**TOTAL 20986 21846 22874 23560 24758 25618 27160 28872 31092 33138**

**34.00 -**

Optional 11.75" (300mm) High-back rest

6548 6706 6894 7020 7240 7398 7680 7994 8402 8778

6.25 -

MODULAR SEATING SYSTEMS

**Options**

CODE:	DESCRIPTION	\$
<b>SUFFIX LM</b>	Set of two linking mechanisms (supplied separately)	110
<b>PIXEL</b>	Pixel - 1x Power and TUF A+C	385

- Not recommended to be upholstered in Grade 1 fabrics





04.

# Focus Booths



## Range Information

- Swivel base unit
- Fixed lumbar cushion
- Fully upholstered heat welded vertical fluting internal upholstery - always Gabriel Europost (see below) available in 2 standard colours
- Contoured design to reduce peripheral vision for maximum privacy
- External upholstery, seat and lumbar cushion may be any fabric or vinyl
- (Boss Design cannot upholster Cega in leather due to hide yield)
- External twin stitch detail with internal and external piping
- Not recommended to be upholstered in Grade 1 fabrics



CEG/1 BOOTH	Code:	Description	COM /1	2	3	4	5	6	7	8	9	10	(ly)	(lb)
 <p><b>DIMENSIONS</b>            Height: 1700mm (67")            Width: 655mm (26")            Depth: 655mm (26")            Seat Height: 450mm (18")</p>	CEG/1	High Back privacy seat, swivel base	5532	5690	5878	6004	6224	6382	6664	6978	7386	7762	6.25	-

FOCUS BOOTHS

N.B. Leather is a natural material which will crease and 'puddle'.

 Fabric Linear Yard
  Leather Square Footage
  Product Weight

## Options

CODE:	DESCRIPTION	\$
WT*	Writing tablet*	

\* Writing tablet cannot be retrofitted

Internal Gabriel Europost heat welded fabric choices:\*\*

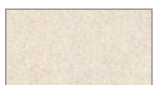

60000



60016

\*\*Any internal Gabriel Europost fabric ordered outside of the above standard options will be subject to a minimum order quantity of 10 units or incur a surcharge relative to the number of units ordered, please contact the sales office for more information.

N.B. Due to the printing process, please note that color options shown are merely indicative of actual shades of each colour/finish.



Imagine the comfort of a sofa combined with the postural support of a traditional desk and task chair. Meet Cocoon, a high back sofa with a roof expertly engineered and designed to absorb background noise and insulate from external distraction.

Offering infinite possibilities: create warm, informal areas for collaboration or provide a base for visitors or nomad workers. Cocoon can be finished in a range of colors and offers optimum ease of movement, thanks to castors and slimline shape that fits easily through a standard doorway.



**COC/1  
SOFA**

Code:	Description	COM /1	2	3	4	5	6	7	8	9	10	(ly)	(lb)
-------	-------------	--------	---	---	---	---	---	---	---	---	----	------	------



<b>COC/1</b>	High-back sofa	12416	12704	13050	13280	13684	13972	14490	15066	15814	16504	12	
--------------	----------------	-------	-------	-------	-------	-------	-------	-------	-------	-------	-------	----	--

**DIMENSIONS**

Height: **1775mm (70")**  
 Width: **2015mm (79.5")**  
 Depth: **710mm (28")**

SOFA / BOOTHS

Fabric Linear Yard Leather Square Footage Product Weight

**Options**

CODE:	DESCRIPTION	\$
L	LED strip lights (COC/1)	POA

**Range Information**

- Fabric on external and internal hoop must be Camira Synergy Hourglass 8 standard colours available
- Front and rear panels upholstered in any fabric (cannot be upholstered in leather or vinyl)
- Seat and lumbar cushion upholstered in any fabric, leather or vinyl
- Available with power and data - See page 524 for full range available
- CMHR moulded seat and back foam
- Media unit is available with standard Laminate table tops - See media units section
- Not recommended to be upholstered in Grade 1 fabrics

# Entente

Booths

boss





Entente is a distinctive collaborative workspace that blends corporate needs with hospitality style.

Incorporating power and data and cable management provision, this spectacular high booth and sofa hybrid features two high-back sofas surrounding table with an interconnecting panel.

BOOTH



## Booths

### Entente High Back

Hardwood and plywood internal frame structure

Polished aluminum legs as standard

CMHR foam seat, back and lumbar

Webbed Seat

Top stitch detail

Two tone fabric choices are available for specification

### High Back - Individual units

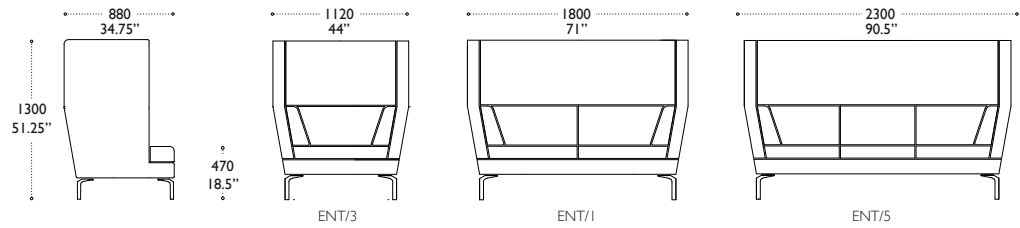

### Entente Low Back

Hardwood and plywood internal frame structure

Polished aluminum legs as standard

CMHR foam seat, back and lumbar

Webbed Seat

Top stitch detail

Two tone fabric choices are available for specification

### Low Back - Individual units

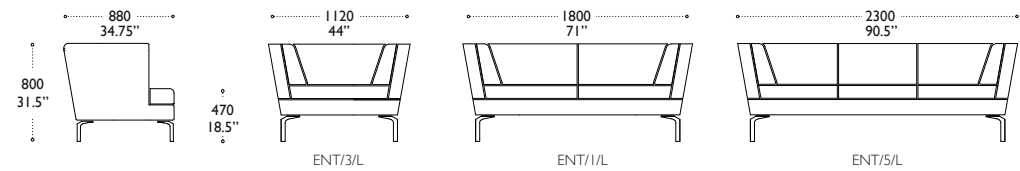

### Power & Data Locations

Various power and data options are available to specify on Entente however we have listed our most popular configurations in the options tables.

Drawings are provided for your reference prior to ordering and can be used as a guide

For customers own power please contact us for compatibility

ENT/2 & ENT/2/L

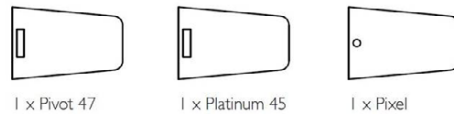

ENT/4 & ENT/4/L

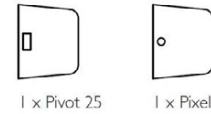

ENT/6 & ENT/6/L

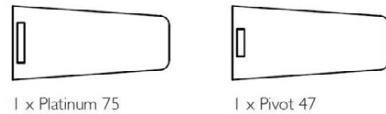

### Media Unit: Partition Cable Management

Entente booth units feature concealed cable management in the rear of the partition unit, with 4 positions available for exit grommets to be placed.

Please ensure you state which location you require at the point of order.

Maximum monitor size 27"

### Entente Partition - Cable Management

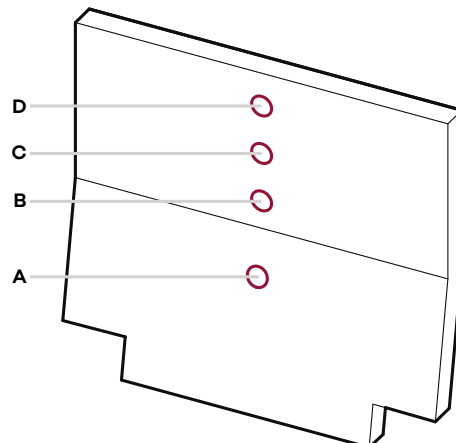
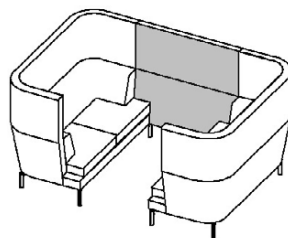

- A - Cable exit grommet below table
- B - Cable exit grommet above table - Low
- C - Cable exit grommet above table - Medium
- D - Cable exit grommet above table - High

## Specification

### Entente Specification

Entente is available as standalone sofa unit or as a media booth with table. **N.B.** if specifying a media booth, a monitor and monitor arm is NOT included

### Fabrics

Entente can be specified in a multitude of fabrics however we find that Grade 1 fabrics generally aren't suitable for large pieces such as Entente. If there is a Grade 1 fabric you wish to use, please contact a member of our customer services team to discuss suitability.

### High or Low back

Entente is available in either high back or Low back configurations:  
 High Back - 51" (1300mm) High  
 Low Back - 31.5" (800mm) High

### Leg Options

Entente is available as standard with Polished aluminum legs, however it can also be specified with Oak or American Black Walnut legs for an additional up-charge.

### Media Booth: Tables

The media unit tables are 28" (715mm) high and attach to the connecting partition wall (which features discreet/concealed cable management)

### Media Booth: Table Finishes

Entente Media Booth tables feature a 1" (25mm) top with a chamfered edge and are available in the following finishes:  
 MF MDF - White, Oak or American Black Walnut  
 Veneer - Oak or American Black Walnut  
 High Pressure Laminate - Standard Boss Colors

### Table Leg finish:

Polished as standard  
 Oak or American Black Walnut for an additional upcharge.

### Media Booth: Table Power Options

Power and data units are placed on the center line of the table and are positioned near the connecting partition as standard. Power options are dependant on table size so please consult the drawing (left) for more information. If a power option is not listed, or you wish to use an alternative, then please contact your sales representative.

A 72" starter cable is supplied as standard however other lengths are available - see power & data for more information.

### Entente Digital Assets

We hold a library of assets for our Entente product range which you can find by scanning the the QR code below. If you are viewing our interactive PDF, simply click on the QR code to be taken directly there.

#### High Back - Booth units

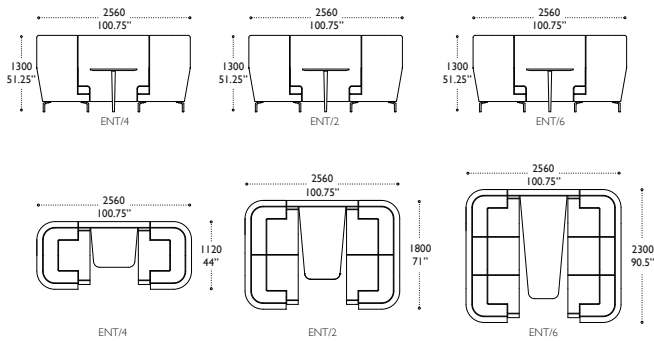

#### Low Back - Booth Units

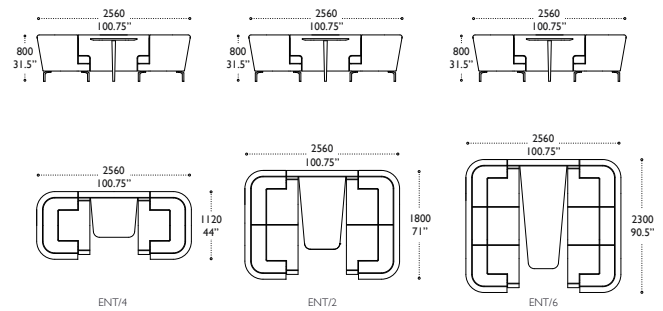

#### High Back - Suggested Settings

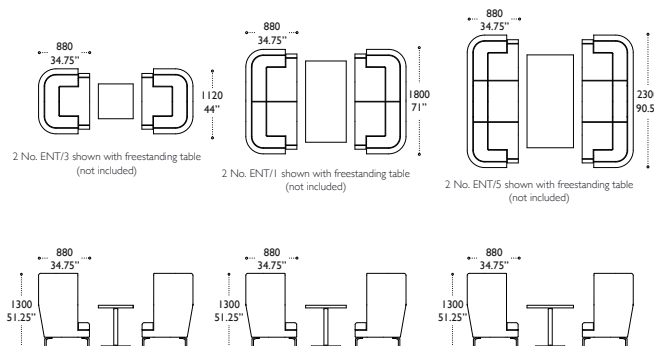

#### Low Back - Suggested Settings

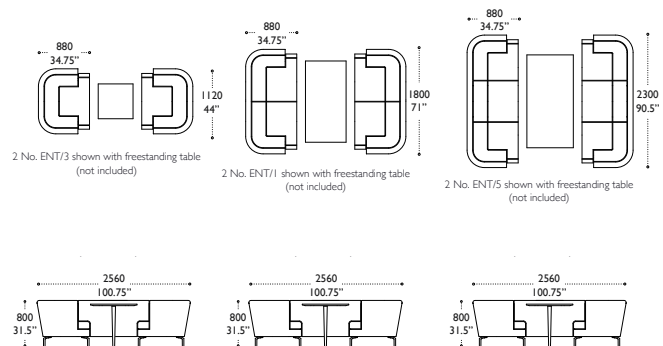

# Entente – High Back

boss

Booths







## Range Information

- Hardwood & plywood internal frame
- CMHR foam seat, back and lumbar
- Webbed seat
- Top stitch detail
- Booth table top available in Oak, ABW or White finish – please specify on Purchase Order
- Connecting partition with provision for concealed cable management
- Power and data available - See power & data page
- Polished aluminum legs as standard. Please refer to price options for alternative timber leg options and state selection on Purchase Order.
- Maximum monitor size = 27"
- Monitor Not Included
- Not recommended to be upholstered in Grade 1 fabrics
- **Due to the design of Entente we recommend prior fabric approval to ensure the highest quality finish.**

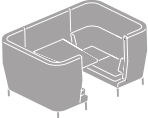

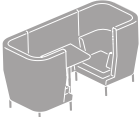
**ENTENTE HIGH BACK  
ENT/...**

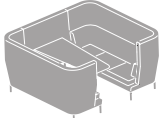
	Code:	Description	COM /1	2	3	4	5	6	7	8	9	10	(ly)	(lb)
	<b>ENT/1</b>	Entente 2 seat High-back sofa	3930	4150	4414	4590	4898	5118	5512	5950	6520	7046	9	
		Lumbar	1168	1226	1294	1340	1420	1478	1580	1694	1842	1978	2	
		Seat cushions	1044	1102	1170	1216	1296	1354	1456	1570	1718	1854	2	
		<b>Total \$</b>	<b>6142</b>	<b>6478</b>	<b>6878</b>	<b>7146</b>	<b>7614</b>	<b>7950</b>	<b>8548</b>	<b>9214</b>	<b>10080</b>	<b>10878</b>	13	
	<b>ENT/2</b>	Entente 2 seat booth High-back sofa body	7860	8300	8828	9180	9796	10236	11024	11900	13040	14092	18	
		Lumbar	2336	2452	2588	2680	2840	2956	3160	3388	3684	3956	5	
		Seat cushions	2088	2204	2340	2432	2592	2708	2912	3140	3436	3708	5	
		Partition, table and allowances for P&D (if required)	4972	5060	5166	5236	5360	5448	5606	5782	6010	6220	4	
		<b>Total \$</b>	<b>17256</b>	<b>18016</b>	<b>18922</b>	<b>19528</b>	<b>20588</b>	<b>21348</b>	<b>22702</b>	<b>24210</b>	<b>26170</b>	<b>27976</b>	30	
	<b>ENT/3</b>	Entente 1 seat High-back chair	2988	3126	3292	3402	3596	3734	3982	4258	4616	4946	6	
		Lumbar	888	946	1014	1060	1140	1198	1300	1414	1562	1698	2	
		Seat cushion	794	852	920	966	1046	1104	1206	1320	1468	1604	2	
		<b>Total \$</b>	<b>4670</b>	<b>4924</b>	<b>5226</b>	<b>5428</b>	<b>5782</b>	<b>6036</b>	<b>6488</b>	<b>6992</b>	<b>7646</b>	<b>8248</b>	10	
	<b>ENT/4</b>	Entente 1 seat booth High-back chair body	5976	6252	6582	6802	7188	7464	7960	8510	9226	9886	11	
		Lumbar	1774	1888	2024	2114	2272	2386	2590	2816	3110	3380	5	
		Seat cushions	1588	1702	1838	1928	2086	2200	2404	2630	2924	3194	5	
		Partition, table and allowances for P&D (if required)	3918	4006	4112	4182	4306	4394	4552	4728	4956	5166	4	
		<b>Total \$</b>	<b>13256</b>	<b>13848</b>	<b>14556</b>	<b>15026</b>	<b>15852</b>	<b>16444</b>	<b>17506</b>	<b>18684</b>	<b>20216</b>	<b>21626</b>	24	
	<b>ENT/5</b>	Entente 3 seat High-back sofa	5068	5318	5618	5818	6168	6418	6868	7368	8018	8618	10	
		Lumbar	1506	1564	1632	1678	1758	1816	1918	2032	2180	2316	2	
		Seat cushions	1348	1436	1542	1612	1736	1824	1982	2158	2386	2596	4	
		<b>Total \$</b>	<b>7922</b>	<b>8318</b>	<b>8792</b>	<b>9108</b>	<b>9662</b>	<b>10058</b>	<b>10768</b>	<b>11558</b>	<b>12584</b>	<b>13530</b>	16	
	<b>ENT/6</b>	Entente 3 seat booth High-back sofa body	10134	10628	11222	11618	12310	12804	13694	14682	15966	17152	20	
		Lumbar	3010	3124	3260	3350	3508	3622	3826	4052	4346	4616	5	
		Seat cushions	2692	2862	3066	3202	3440	3610	3914	4252	4692	5098	7	
		Partition, table and allowances for P&D (if required)	5888	5976	6082	6152	6276	6364	6522	6698	6926	7136	4	
		<b>Total \$</b>	<b>21724</b>	<b>22590</b>	<b>23630</b>	<b>24322</b>	<b>25534</b>	<b>26400</b>	<b>27956</b>	<b>29684</b>	<b>31930</b>	<b>34002</b>	35	

BOOTH

 Fabric Linear Yard  Leather Square Footage  Product Weight

**Options**

CODE:	DESCRIPTION	\$
<b>CUTOUT</b>	Cut out for customers own power & data	88
-	Oak Legs - Sofa and Chair	310
-	Oak Legs Booth including table	664
-	American Black Walnut Legs - Sofa & Chair	492

CODE:	DESCRIPTION	\$
-	American Black Walnut Legs Booth Including table	1,126
<b>P&amp;D</b>	Power & Data options - See page 524	
<b>PAINTED</b>	Painted Metal Legs - Any Standard RAL	70 Per Leg

# Entente – Low Back

boss

Booths





## Range Information

- Hardwood & plywood internal frame
- CMHR foam seat, back and lumbar
- Webbed seat
- Top stitch detail
- Booth table top available in Oak, ABW or White finish – please specify on Purchase Order.
- Connecting partition with provision for concealed cable management
- Power and data available - See page 524
- Polished aluminum legs as standard. Please refer to price options for alternative timber leg options and state selection on Purchase Order
- Monitor not available for Low version
- Not recommended to be upholstered in Grade 1 fabrics
- **Due to the design of Entente we recommend prior fabric approval to ensure the highest quality finish.**

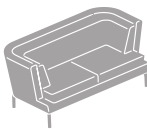
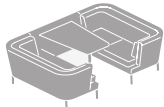

**ENTENTE LOW BACK**  
ENT/.../L

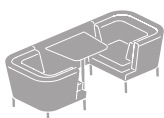
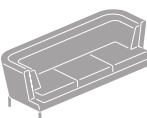
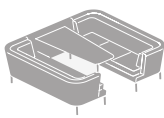
	Code:	Description	COM /1	2	3	4	5	6	7	8	9	10	(ly)	(lb)
	ENT/1/L	Entente 2 seat Low-back sofa	3686	3862	4072	4212	4458	4634	4950	5300	5756	6176	7	
		Lumbar	1096	1154	1222	1268	1348	1406	1508	1622	1770	1906	2	
		Seat cushions	980	1038	1106	1152	1232	1290	1392	1506	1654	1790	2	
		<b>Total \$</b>	<b>5762</b>	<b>6054</b>	<b>6400</b>	<b>6632</b>	<b>7038</b>	<b>7330</b>	<b>7850</b>	<b>8428</b>	<b>9180</b>	<b>9872</b>	12	
	ENT/2/L	Entente 2 seat booth Low-back sofa body	7372	7724	8144	8424	8916	9268	9900	10600	11512	12352	14	
		Lumbar	2192	2308	2444	2536	2696	2812	3016	3244	3540	3812	4	
		Seat cushions	1960	2076	2212	2304	2464	2580	2784	3012	3308	3580	5	
		Partition, table and allowances for P&D (if required)	4412	4476	4552	4602	4690	4754	4868	4994	5158	5308	3	
		<b>Total \$</b>	<b>15936</b>	<b>16584</b>	<b>17352</b>	<b>17866</b>	<b>18766</b>	<b>19414</b>	<b>20568</b>	<b>21850</b>	<b>23518</b>	<b>25052</b>	25	
	ENT/3/L	Entente 1 seat Low-back chair	2688	2788	2908	2988	3128	3228	3408	3608	3868	4108	4	
		Lumbar	798	856	924	970	1050	1108	1210	1324	1472	1608	2	
		Seat cushion	714	772	840	886	966	1024	1126	1240	1388	1524	2	
		<b>Total \$</b>	<b>4200</b>	<b>4416</b>	<b>4672</b>	<b>4844</b>	<b>5144</b>	<b>5360</b>	<b>5744</b>	<b>6172</b>	<b>6728</b>	<b>7240</b>	9	
	ENT/4/L	Entente 1 seat booth Low-back chair body	5376	5576	5816	5976	6256	6456	6816	7216	7736	8216	8	
		Lumbar	1596	1712	1848	1940	2100	2216	2420	2648	2944	3216	5	
		Seat cushions	1428	1544	1680	1772	1932	2048	2252	2480	2776	3048	5	
		Partition, table and allowances for P&D (if required)	3808	3872	3948	3998	4086	4150	4264	4390	4554	4704	3	
		<b>Total \$</b>	<b>12208</b>	<b>12704</b>	<b>13292</b>	<b>13686</b>	<b>14374</b>	<b>14870</b>	<b>15752</b>	<b>16734</b>	<b>18010</b>	<b>19184</b>	20	
	ENT/5	Entente 3 seat Low-back sofa	4762	4962	5202	5362	5642	5842	6202	6602	7122	7602	8	
		Lumbar	1414	1472	1540	1586	1666	1724	1826	1940	2088	2224	2	
		Seat cushions	1266	1354	1460	1530	1654	1742	1900	2076	2304	2514	4	
		<b>Total \$</b>	<b>7442</b>	<b>7788</b>	<b>8202</b>	<b>8478</b>	<b>8962</b>	<b>9308</b>	<b>9928</b>	<b>10618</b>	<b>11514</b>	<b>12340</b>	14	
	ENT/6/L	Entente 3 seat booth Low-back sofa body	9520	9920	10400	10720	11280	11680	12400	13200	14240	15200	16	
		Lumbar	2826	2940	3076	3166	3324	3438	3642	3868	4162	4432	5	
		Seat cushions	2530	2700	2904	3040	3278	3448	3752	4090	4530	4936	7	
		Partition, table and allowances for P&D (if required)	4640	4704	4780	4830	4918	4982	5096	5222	5386	5536	3	
		<b>Total \$</b>	<b>19516</b>	<b>20264</b>	<b>21160</b>	<b>21756</b>	<b>22800</b>	<b>23548</b>	<b>24890</b>	<b>26380</b>	<b>28318</b>	<b>30104</b>	30	

BOOTH

 Fabric Linear Yard  Leather Square Footage  Product Weight

**Options**

CODE:	DESCRIPTION	\$
<b>CUTOUT</b>	Cut out for customers own power & data	88
-	Oak Legs - Sofa and Chair	310
-	Oak Legs Booth including table	664
-	American Black Walnut Legs - Sofa & Chair	492

CODE:	DESCRIPTION	\$
-	American Black Walnut Legs Booth Including table	1,126
<b>P&amp;D</b>	Power & Data options - See page 524	
<b>PAINTED</b>	Painted Metal Legs - Any Standard RAL	70 Per Leg

# Mango

Focus Booths

boss



## Range Information

- References to LH and RH are from the seated position.
- For ease of access, the privacy screen is always mounted on the same side as the writing tablet.
- Mango is available with a Phase power unit - 1 x US Power and 2x USB charging with a 72" starter lead.
- The Mango surround and privacy screens cannot be upholstered in leather\*
- The Mango surround and privacy screens can only be upholstered in Nassimi Classic Vinyl and Camira & Kvadrat

foam-backed fabrics (Camira Main Line Plus and Main Line Flax are excluded)

- \*As standard, the Mango foot stool is finished in Skai Sotega Anthracite Vinyl across the front, top, rear and the handle so that it provides the durability required to prevent marking from users' feet. The sides are upholstered in the fabric used on the body of the chair. To have the sides upholstered in a different fabric or colour, cost is POA.
- Please note: Screens and shelves cannot be retrofitted to Mango.

- Not recommended to be upholstered in Grade 1 fabrics



FOCUS BOOTHS



Mango strikes the perfect balance between privacy and ergonomics. Mango allows its user to comfortably escape distractions for extended periods of time without the need to leave the room.

MANGO	Code:	Description	COM /1										(ly)	(lb)
			2	3	4	5	6	7	8	9	10			
 <p><b>DIMENSIONS</b>            Height: <b>890mm (35")</b>            Seat Height: <b>465mm (18")</b>            Depth: <b>925mm (37")</b>            Width: <b>985mm (39")</b></p>	<b>MGO/1</b>	Mango Chair	3500	3682	3900	4046	4300	4482	4810	5174	5646	6082	7	
 <p>Height: <b>1400mm (55")</b>            Seat Width: <b>800mm (31.5")</b>            Depth: <b>990mm (39")</b>            Width: <b>1020mm (40")</b></p>	<b>MGO/1/HB</b>	Mango with surround screen	6196	6528	6926	7192	7656	7988	8586	9250	10112	10908	13	
	<b>MGO/1/HB/PS-RH</b>	Mango with surround screen & right hand privacy screen	7642	8042	8522	8842	9402	9802	10522	11322	12362	13322	16	
 <p>Height: <b>1400mm (55")</b>            Screen Width: <b>500mm (20")</b>            Depth: <b>1530mm (60")</b>            Width: <b>10400mm (41")</b></p>	<b>MGO/1/HB/PS-LH</b>	Mango with surround screen & left hand privacy screen	7642	8042	8522	8842	9402	9802	10522	11322	12362	13322	16	

 Fabric Linear Yard  Product Weight



Scan or click me to view detailed dimensions for the complete Mango Range

**MANGO CONFIGURATIONS**

	Code:	Description	COM /										(ly)	(lb)
			1	2	3	4	5	6	7	8	9	10		
	<b>MGO/1/SF/P/T-RH</b>	Mango Chair with Phase power, shelves and Right Hand articulated writing tablet.	5246	5428	5646	5792	6046	6228	6556	6920	7392	7828	7	
	<b>MGO/1/SF/P/T-LH</b>	Mango Chair with Phase power, shelves and Left Hand articulated writing tablet.	5246	5428	5646	5792	6046	6228	6556	6920	7392	7828	7	
	<b>MGO/1/HB/SF/P/T-RH</b>	Mango with surround screen, Phase power, shelves and Right Hand articulated writing tablet.	7956	8288	8686	8952	9416	9748	10346	11010	11872	12668	13	
	<b>MGO/1/HB/SF/P/T-LH</b>	Mango with surround screen, Phase power, shelves and Left Hand articulated writing tablet.	7956	8288	8686	8952	9416	9748	10346	11010	11872	12668	13	
	<b>MGO/1/HB/PS-RH/SF/P/T-RH</b>	Mango with surround screen and right hand privacy screen, Phase power, shelves and right hand articulated writing tablet.	9460	9860	10340	10660	11220	11620	12340	13140	14180	15140	16	
	<b>MGO/1/HB/PS-LH/SF/P/T-LH</b>	Mango with surround screen and left hand privacy screen, Phase power, shelves and left hand articulated writing tablet.	9460	9860	10340	10660	11220	11620	12340	13140	14180	15140	16	

**DIMENSIONS**

Table Height: **760mm (30")**  
 Table Width: **470mm (18.5")**  
 Table Depth: **390mm (15.5")**  
 Shelf Height: **760mm (30")**



Scan or click me to view detailed dimensions for the complete Mango Range

Fabric Linear Yard Product Weight

**Options**

CODE:	DESCRIPTION	\$
<b>P</b>	Phase - 1x US power with 2x USB Charging	496
<b>SF</b>	Steel shelves (pair) - RAL 9016	192

CODE:	DESCRIPTION	\$
<b>T-RH</b>	Articulated Writing Tablet Right Hand - White	798
<b>T-LH</b>	Articulated Writing Tablet Left Hand - White	798
<b>FS</b>	Mango Foot Stool*	726

FOCUS BOOTHS

# Peek & Boo

Booths

boss



Peek and Boo is a playful duo ideally suited to the contemporary workplace. Designed by Boss Design, Peek and Boo reflect the change towards a comfortable, informal working environment where single person work booths are the norm.

Peek and Boo can be used independently to create private spaces in open plan environments, or alongside each other to enhance collaborative working.



FOCUS BOOTHS



## Range Information

- Seat and back constructed from timber frame and CMHR foam
- Swivel base plate with felt pads
- Fixed lumbar cushion
- Sprung seat
- Seat and lumbar can be upholstered in any fabric or leather
- Twin stitch detail
- Compatible with height adjustable Flamingo table
- Leather Boo unit and Fabric screen mix POA
- Power & Data cannot be specified on this range
- Not recommended to be upholstered in Grade 1 fabrics



**BOO/1  
BOOTH**

**Code:**      **Description**      **COM**    **2**    **3**    **4**    **5**    **6**    **7**    **8**    **9**    **10**    **COL**    **L1**    **L2**    **L3**

(ly)    (ft²)    (lb)



**BOO/1**      Boo with swivel      2490   2616   2766   2866   3042   3168   3394   3644   3970   4270   2644   4040   4894   7504

5      90

**DIMENSIONS**  
 Height: **760mm (29.75")**  
 Width: **910mm (39.75")**  
 Depth: **680mm (26.5")**  
 Seat Height: **440mm (17.25")**

**PEK/1  
BOOTH**

**Code:**      **Description**      **COM**    **2**    **3**    **4**    **5**    **6**    **7**    **8**    **9**    **10**    **COL**

(ft²)    (lb)



**PEK/1**      Peek upholstered screen with Boo unit with swivel      4762   5056   5410   5646   6058   6352   6882   7470   8234   8940   N/A

12

**DIMENSIONS**  
 Height: **1450mm (57.25")**  
 Width: **910mm (39.75")**  
 Depth: **730mm (28.5")**  
 Seat Height: **440mm (17.25")**

FOCUS BOOTHS

Fabric Linear Yard    Leather Square Footage    Product Weight

# Shuffle

Focus Booth





boss



Shuffle provides an informal meeting space with endless configuration possibilities. Available as a high and low back option the contoured design enhances the acoustic properties and absorbs ambient background noise.

Based around one simple unit, Shuffle can be used for all current office functions associated with soft upholstery such as touchdown and breakout areas, meeting spaces and partitioning.

- Contoured back for enhanced privacy
- CMHR moulded seat and back foam upholstered in any fabric
- Large glides for ease of reconfiguration
- Pixel units can be Integrated
- Not recommended to be upholstered in Grade 1 fabrics

SHU/1	Code:	Description	COM/1	2	3	4	5	6	7	8	9	10	 (ly)	 (ft <sup>2</sup> )	 (lb)
	SHU/1	Shuffle low-back	2974	3118	3292	3408	3610	3754	4014	4302	4676	5022	5	90	

**DIMENSIONS**  
 Height: 970mm (38.25")  
 Width: 770mm (30.25")  
 Depth: 770mm (30.25")  
 Seat Height: 460mm (18")  
 Seat Depth: 510mm (20.25")

SHU/2	Code:	Description	COM/1	2	3	4	5	6	7	8	9	10	 (ly)	 (lb)
	SHU/2	Shuffle high-back	3078	3236	3424	3550	3770	3928	4210	4524	4932	5308	12	

**DIMENSIONS**  
 Height: 1500mm (59")  
 Width: 770mm (30.25")  
 Depth: 770mm (30.25")  
 Seat Height: 460mm (18")  
 Seat Depth: 510mm (20.25")

FOCUS BOOTHS

 Fabric Linear Yard  Leather Square Footage  Product Weight



# Snug

Work Booths

boss



For today's busy working environments, Snug's design offers privacy and shuts you off from distractions, keeping you focused.



WORK BOOTHS





### Range Information

- One, two & three person workbooths
- Ease of assembly and reconfiguration
- Acoustic properties
- Desktop supplied with two cable ports as standard
- Feed through cable grommet in internal panels
- Levelling feet on all panels
- Optional cable management





**Product  
Certification**

BS EN 15373: 2007, Level 2

SNUG & SNUG PLUS	Code:	Description	Blazer Lite Inner & Outer	Blazer Inner & Outer	Synergy Quilt Inner Blazer Outer	Synergy Quilt Inner & Outer	(ly)	(lb)
	SNU/1/L	Single seat work booth at 55" (1400mm) high Width: 47.25" (1200mm) Depth: 29.5" (1000mm) Laminate Table: D27.5" (700mm) 1x LH or RH Grommet	5904	6020	6324	6642	-	-
	SNU/1/H	Single seat work booth at 67.5" (1715mm) high Width: 47.25" (1200mm) Depth: 29.5" (1000mm) Laminate Table: D27.5" (700mm) 1x LH or RH Grommet	5940	6050	6388	6734	-	-
	SNU/2/L	Run of two work booths at 55" (1400mm) high Width: 94.5" (2400mm) Depth: 29.5" (1000mm) Laminate Table: D27.5" (700mm) 1x LH or RH Grommet	10222	10426	11000	11488	-	-
	SNU/2/H	Run of two work booths at 67.5" (1715mm) high Width: 94.5" (2400mm) Depth: 29.5" (1000mm) Laminate Table: D27.5" (700mm) 1x LH or RH Grommet	10146	10348	10970	11492	-	-
	SNU/3/L	Run of three work booths at 55" (1400mm) high Width: 141.75" (3600mm) Depth: 29.5" (1000mm) Laminate Table: D27.5" (700mm) 1x LH or RH Grommet	14628	14918	15762	16414	-	-
	SNU/3/H	Run of three work booths at 67.5" (1715mm) high Width: 141.75" (3600mm) Depth: 29.5" (1000mm) Laminate Table: D27.5" (700mm) 1x LH or RH Grommet	14370	14650	15574	16274	-	-
	SNU/PLUS/LH	Single seat work booth with return screen and left-hand opening Width: 47.25" (1200mm) Depth: 29.5" (1000mm) Laminate Table: D27.5" (700mm) 1x LH or RH Grommet	7166	7310	7700	8058	-	-
	SNU/PLUS/RH	Single seat work booth with return screen and right-hand opening Width: 47.25" (1200mm) Depth: 29.5" (1000mm) Laminate Table: D27.5" (700mm) 1x LH or RH Grommet	7166	7310	7700	8058	-	-

WORK BOOTHS

 Fabric Linear Yards  Product Weight

**Options**

CODE:	DESCRIPTION	\$
PIXEL	1x US Power & TUF A&C	385
HCT	Horizontal cable tray - 35.5" - White finish	126
VCS	Weighted vertical cable spine with Silver finish	110

**Camira Synergy Quilt Hourglass - Color ways**

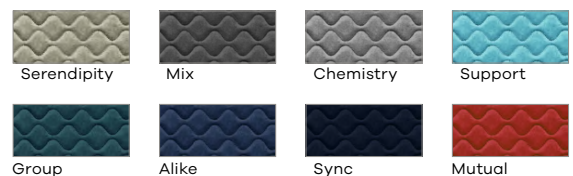



05.

**Task  
Chairs**



# Coza

Task Chairs

boss



The result of two years of research, Coza is a task chair that boasts extraordinary comfort and dynamic support by using the natural flexibility of a single ribbon of material.

Coza fulfils the increasing need for ergonomically-sound meeting chairs and provides a task chair that offers a high level of comfort without the need for manual user adjustment.



TASK CHAIRS



## Range Information

- Made from a single organic ribbon that sweeps from under the seat, through the arm and over the backrest creating an incredibly slim and refined shape to compliment the human form.
- Choice of 4 or 5 star base with casters or glides.
- The upholstered seat can be finished in any fabric colour.
- Coza can be used as a workstation chair, as well as being suitable for touchdown and meeting settings.
- Coza is available in four standard colours: Pure White, Graphite Black, Azure Blue and Stone Grey.
- Special colours are available upon request against a strict minimum batch quantity of 200 units.



**COZ/1  
TASK SEATING**



**DIMENSIONS**

Height: **900-1010mm (35.25"-39.75")**  
 Width: **610mm (23.75")**  
 Depth: **750mm (29.5")**  
 Seat Height: **400-510mm (15.5-20")**

Code:	Description	COM /1	2	3	4	5	6	7	8	9	10	COL	L1	L2	L3	(ly)	(lb)
COZ/1/BL	Black polymer shell with upholstered seat, on 5 star black nylon base with black casters	1064	1096	1134	1160	1204	1236	1294	1358	1440	1516	N/A	N/A	N/A	N/A	1	
COZ/1/B	Blue polymer shell with upholstered seat, on 5 star black nylon base with black casters	1064	1096	1134	1160	1204	1236	1294	1358	1440	1516	N/A	N/A	N/A	N/A	1	
COZ/1/W	White polymer shell with upholstered seat, on 5 star black nylon base with black casters	1064	1096	1134	1160	1204	1236	1294	1358	1440	1516	N/A	N/A	N/A	N/A	1	
COZ/1/SG	Stone Grey polymer shell with upholstered seat, on 5 star black nylon base with black casters	1064	1096	1134	1160	1204	1236	1294	1358	1440	1516	N/A	N/A	N/A	N/A	1	

**COZ/2  
TASK SEATING**



**DIMENSIONS**

Height: **1180-1290mm (46.5"-50.75")**  
 Width: **610mm (23.75")**  
 Depth: **750mm (29.5")**

Code:	Description	COM /1	2	3	4	5	6	7	8	9	10	COL	L1	L2	L3	(ly)	(lb)
COZ/2/BL	Black cashier, polymer shell with arms and upholstered seat, on 5 star black nylon base with black casters	1140	1172	1210	1236	1280	1312	1370	1434	1516	1592	N/A	N/A	N/A	N/A	1	
COZ/2/B	Blue cashier, polymer shell with arms and upholstered seat, on 5 star black nylon base with black casters	1140	1172	1210	1236	1280	1312	1370	1434	1516	1592	N/A	N/A	N/A	N/A	1	
COZ/2/W	White cashier, polymer shell with arms and upholstered seat, on 5 star black nylon base with black casters	1140	1172	1210	1236	1280	1312	1370	1434	1516	1592	N/A	N/A	N/A	N/A	1	
COZ/2/SG	Stone Grey cashier, polymer shell with arms and upholstered seat, on 5 star black nylon base with black casters	1140	1172	1210	1236	1280	1312	1370	1434	1516	1592	N/A	N/A	N/A	N/A	1	

TASK CHAIRS

Fabric Linear Yard Leather Square Footage Product Weight

**Options**

CODE:	DESCRIPTION	\$
/P4	Polished 4 star base with black casters	132
/P5	Polished 5 star base with black casters	134
/G4	Polished 4 star glide base	336
/G5	Polished 5 star glide base	406
/SC	Silver Casters	88
/PLASTIC GLIDES4	Plastic 4 Star glide base	POA
/PLASTIC GLIDES 5	Plastic 5 Star glide base	POA

**Product Certification**  
 BS EN 1335:2000, Part 1,2 & 3  
 ISO 9241:Part 5  
 ANSI BIFMA X5.1 (Stability)



# Delphi

Chair Collection

boss



Conceived by Boss Design's team of design engineers over 25 years ago, Delphi is the formula one of boardroom chairs. With an international reputation for ergonomic support, comfort and uncompromising British quality and design, its sprung

steel frame, engineered seat and back with Pirelli webbing make it as comfortable as it is durable. Available in both high and low back, with a swivel or fixed base. It can also be upholstered in a wide range of beautiful fabrics and butter soft leathers.



CHAIRS



**Range Information**

- Fully upholstered in any fabric or leather
- Available as a swivel chair or stackable visitor chair in high and low back configurations
- Gas height adjustment - 4" (100mm)
- Upholstered arm pads available
- Tilt mechanism
- High and Low-back options
- Stackable 3 high
- (Visitor chair: DEL/6, DEL/5, DEL/7+8, DEL/9)



DEL/ TASK SEATING	Code:	Description	COM /1	2	3	4	5	6	7	8	9	10	COL	L1	L2	L3	(ly)	(ft²)	(lb)	CHAIRS
	DEL/1	High-back swivel chair, upholstered arms, chrome frame, polished aluminum 5 star base	1690	1754	1830	1880	1968	2032	2146	2272	2436	2586	1772	2470	2898	4202	3	45		
	DEL/2	Low-back swivel chair, upholstered arms, chrome frame, polished aluminum 5 star base	1534	1578	1632	1668	1730	1774	1854	1942	2056	2162	1594	2090	2394	3322	2	32		
	DEL/3	High-back visitor chair, upholstered arms, chrome frame	1518	1582	1658	1708	1796	1860	1974	2100	2264	2414	1598	2296	2724	4028	3	45		
	DEL/4	High-back visitor chair, Non-arm, chrome frame	1166	1224	1292	1338	1418	1476	1578	1692	1840	1976	1238	1874	2264	3452	2	41		
	DEL/5	Low-back visitor chair, upholstered arms, chrome frame	1242	1286	1340	1376	1438	1482	1562	1650	1764	1870	1300	1796	2100	3028	2	32		
	DEL/6	Low-back visitor chair, Non-arm, chrome frame	1000	1044	1098	1134	1196	1240	1320	1408	1522	1628	1056	1552	1856	2784	2	32		
	DEL/7	Low-back stacking chair, upholstered arms, chrome frame	1250	1294	1348	1384	1446	1490	1570	1658	1772	1878	1308	1804	2108	3036	2	32		
	DEL/8	Low-back stacking chair, PU arms, chrome frame	1150	1194	1248	1284	1346	1390	1470	1558	1672	1778	1206	1702	2006	2934	2	32		
	DEL/9	Low-back stacking chair, Non-arm, chrome frame	1004	1048	1102	1138	1200	1244	1324	1412	1526	1632	1060	1556	1860	2788	2	32		

N.B. Leather is a natural material which will crease and 'puddle'.

Fabric Linear Yard Leather Square Footage Product Weight

**DIMENSIONS**

High Back

Height: **1040mm (40.75")**  
 Width: **620mm (24.25")**  
 Depth: **720mm (28.25")**  
 Seat Height: **425-525mm (16.75-20.75")**  
 Seat Depth: **470mm (18.25")**  
 Arm Height: **660mm (26.25")**

Low Back

Height: **810mm (32")**  
 Width: **620mm (24.25")**  
 Depth: **670mm (26.25")**  
 Seat Height: **425-525mm (16.75-20.75")**  
 Seat Depth: **470mm (18.25")**  
 Arm Height: **660mm (26.25")**

**Options**

CODE:	DESCRIPTION	\$
MR	Memory Return	76

Product Certification
Low-back visitor chair BS EN 13761:2002



# Tauro

Task Seating

boss



The Tauro task chair has been designed to offer maximum comfort and support through each working day. Its intuitive adjustments make it ideal for today's flexible workspaces.

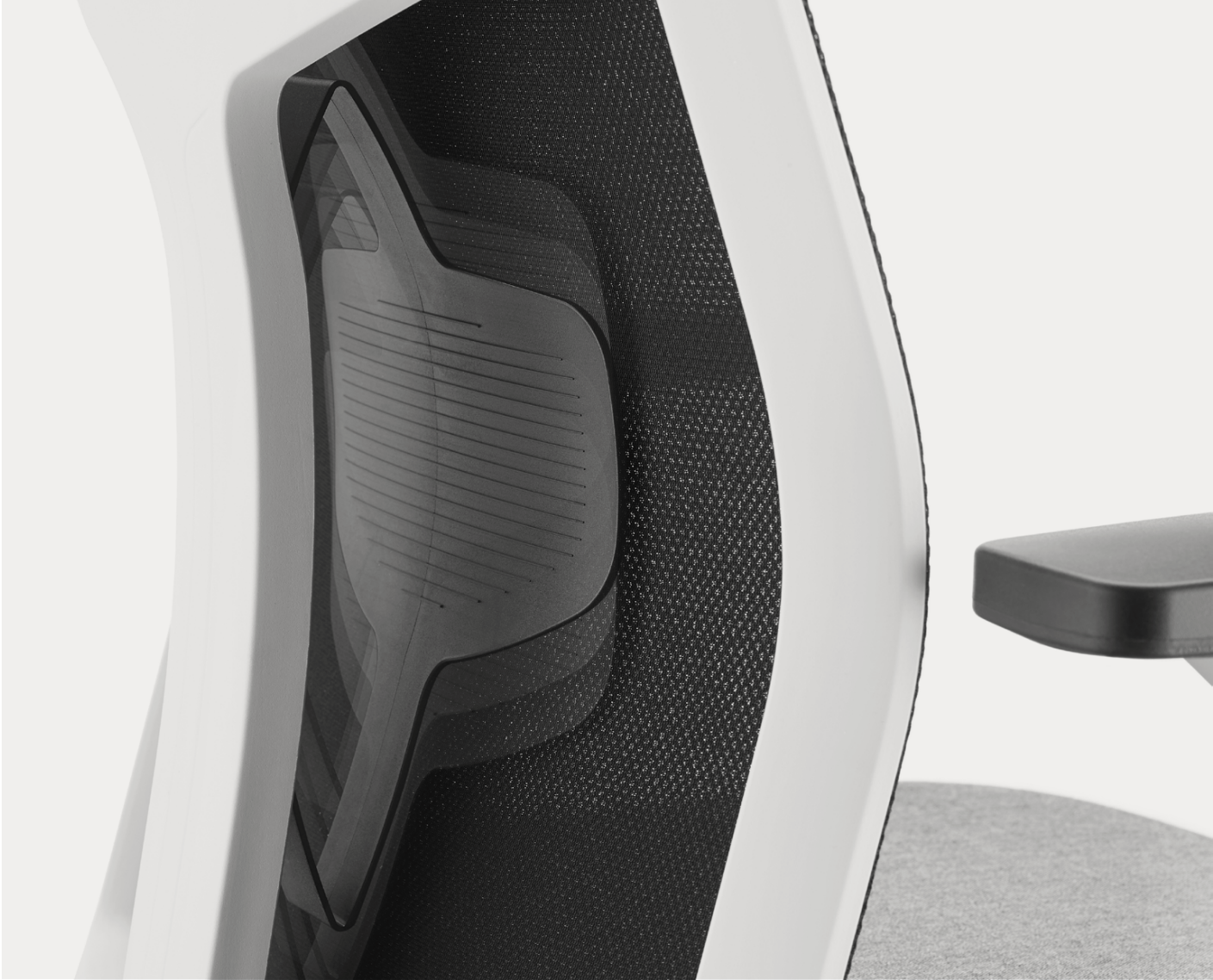

TASK SEATING





## Range Information

- Tauro is available in a wide range of upholstery fabrics, but we recommend the following 100% recycled PET fabrics for optimal sustainable performance:

**Camira Oceanic:**

<https://www.camirafabrics.com/en/fabrics/contract/oceanic>

**Kvadrat Reflect:**

<https://www.kvadrat.dk/en/products/upholstery/7798-reflect>

- The standard mesh back is Gabriel's 'Runner' for which we stock Black (60025) and Grey (60011). The rest of the Gabriel Runner colour palette is available against a minimum order quantity of 20 chairs. Contact customer services for more information and pricing

[www.gabriel.dk/en/fabrics/colourscale/Runner/30887/colour/37530](http://www.gabriel.dk/en/fabrics/colourscale/Runner/30887/colour/37530)

- Black or Chalk seat and back frames
- 4" (100mm) lumbar height adjustment
- 2.5" (65mm) seat depth adjustment
- 4.75" (120mm) seat height adjustment
- Intuitive weight-balance mechanism with additional tension adjustment
- Black Nylon five-star base with black casters as standard

**TAU/1  
TASK SEATING**

Code:	Description	COM /1	2	3	4	5	6	7	8	9	10	(ly)	(lb)
	Task Chair (without arms)												
	TAU/1 Black component set Black Nylon five-star base and casters	736	762	792	812	848	874	920	970	1036	1096	1	-
	Task Chair (with arms)												
	TAU/1/BH Black component set Black height-adjustable arms Black Nylon five-star base and casters	860	878	900	914	940	958	990	1026	1072	1114	1	-
	Task Chair (without arms)												
	TAU/1/C Chalk component set Black Nylon five-star base and casters	764	782	804	818	844	862	894	930	976	1018	1	-
	Task Chair (with arms)												
	TAU/1/C/CH Chalk component set Chalk height-adjustable arms (with black pads as shown) Black Nylon five-star base and casters	886	904	926	940	966	984	1016	1052	1098	1140	1	-

**DIMENSIONS**

Height: **985-1105mm (38.75-43.5")**  
 Width: **695mm (27.5")**  
 Depth: **680mm (26.75")**  
 Seat Height: **400-520mm (15.75-20.5")**  
 Seat Width: **460mm (18")**  
 Arm Height: **200-300mm (8-12")**

TASK SEATING

Fabric Linear Yard Leather Square Footage Product Weight

**Options**

CODE:	DESCRIPTION	\$
<b>BM</b>	Black Multifunctional Arms Black Arm Pads	156
<b>PM</b>	Polished Multifunctional Arms	248
<b>P5</b>	Polished five star base	134
<b>GABRIEL RUNNER</b>	Gabriel Runner Mesh - Non standard colours Minimum Order Quantity 20 chairs	70 per chair
<b>SC</b>	Silver Casters	80



<b>Product Certification</b>	BS EN 5459:2000 Part 2 BS EN 1335:2000 Part1,2 & 3
------------------------------	---



# Trinetic

Task Chair

boss



As the world's first fully certified task chair to provide dynamic support without the need for manual user adjustments, Trinetic sets the benchmark for the next generation of task seating.



TASK CHAIRS





## Range Information

- Trinetic features three independent pivot points
  - Trinetic is available with or without plastic arm pads in black and chalk (RAL 7035)
  - Black nylon five-star base with black casters as standard
  - Can also be specified with a four or five star base with casters or glides
  - Height adjusts up to 4.75" (120mm)
  - Tested to 275lb (120kg)
- To ensure the highest quality finish, Trinetic is only available in the following fabrics and leathers:
    - 1 - Camira Xtreme Plus
    - 2 - Camira Aquarius
    - 3 - Camira Blazer
    - 4 - Camira Synergy
    - 5 - Kvatrat Steelcut Trio
    - 6 - Kvatrat Steelcut

(including standard Boss black leather)



**TRI/1  
MESH SEAT/MESH BACK  
TASK SEATING**



**DIMENSIONS**

Height: **965-1085mm (38-42.75")**  
 Width: **685mm (27")**  
 Depth: **670mm (26.5")**  
 Seat Height: **400-520mm (15.75-20.5")**  
 Seat Depth: **425mm (16.75)**  
 Arm Height: **630-750mm (24.5")**

Code:	Description	COM /1	2	3	4	5	6	7	8	9	10	COL	L1	L2	L3	(ly)	(lb)
<b>TRI/1/ BLACK</b>	Knitted mesh seat and back with black frames. Black Nylon five-star base with black casters	1330	-	-	-	-	-	-	-	-	-	-	-	-	-	-	1
<b>TRI/1/ CHALK</b>	Knitted mesh seat and back with chalk frames. Black Nylon five-star base with black casters	1340	-	-	-	-	-	-	-	-	-	-	-	-	-	-	1

**TRI/2  
UPHOLSTERED SEAT/MESH  
BACK TASK SEATING**



**DIMENSIONS**

Height: **965-1085mm (38-42.75")**  
 Width: **685mm (27")**  
 Depth: **670mm (26.5")**  
 Seat Height: **400-520mm (15.75-20.5")**  
 Seat Depth: **425mm (16.75)**  
 Arm Height: **630-750mm (24.5")**

Code:	Description	COM /1	2	3	4	5	6	7	8	9	10	COL	L1	L2	L3	(ly)	(ft <sup>2</sup> )	(lb)
<b>TRI/2/ BLACK</b>	Upholstered seat with Gabriel Runner mesh back and black frames. Black Nylon five-star base with black casters	1408	1434	1464	1484	1520	1546	1592	1642	1708	1768	1450	1730	1900	2422	1	18	
<b>TRI/2/ CHALK</b>	Upholstered seat with Gabriel Runner mesh back and chalk frames. Black Nylon five-star base with black casters	1452	1478	1508	1528	1564	1590	1636	1686	1752	1812	1494	1774	1944	2466	1	18	

TASK CHAIRS

N.B. Leather is a natural material which will crease and 'puddle'.

Fabric Linear Yard Leather Square Footage Product Weight

**Options**

CODE:	DESCRIPTION	\$
<b>AB</b>	Black arm pads	46
<b>AC</b>	Chalk arm pads RAL 7035	46
<b>P4</b>	Polished 4 star base	132
<b>P5</b>	Polished 5 star base	134
<b>G4</b>	Polished 4 star glide base	306
<b>G5</b>	Polished 5 star glide base	370
<b>SC</b>	Silver casters	80

**Standard Mesh Options**



<b>Product Certification</b>	BS EN 1335:2000 (Part 1,2 & 3)	ISO 9241: Part 5 ANSI BIFMA X5.1
	BS EN 1335:2009 (Part 2 & 3)	



06.

**Media  
Units**





## Range Information

- Fabric on external and internal hoop must be Camira Synergy Hourglass - 8 standard colours available
- Front and rear panels upholstered in any fabric (cannot be upholstered in leather or vinyl)
- Seat and lumbar cushion upholstered in any fabric, leather or vinyl
- Available with power and data
- CMHR moulded seat and back foam
- Fits through a standard single doorway
- Power & data options are available - see page 524 for compatibility
- Media unit is available with standard Laminate table tops
- Not recommended to be upholstered in Grade 1 fabrics

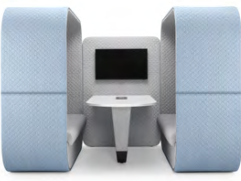

**COC/  
MEDIA UNIT**

Code:	Description	COM /1	2	3	4	5	6	7	8	9	10	(ly)	(lb)
	<b>COC/2</b> Media unit, upholstered back panel	6416	6592	6802	6942	7188	7364	7680	8030	8486	8906	7	
<b>DIMENSIONS</b> Height: <b>1565mm (61.75")</b> Width: <b>1100mm (43.25")</b> Depth: <b>1910mm (75.25")</b>	<b>COC/3</b> Media unit, with whiteboard	6820	6996	7206	7346	7592	7768	8084	8434	8890	9310	7	
	<b>COC/4</b> Media unit, upholstered back panel, poseur	6764	7008	7302	7498	7840	8084	8524	9012	9646	10232	10	
<b>DIMENSIONS</b> Height: <b>1875mm (73.75")</b> Width: <b>1100mm (43.25")</b> Depth: <b>1910mm (75.25")</b>	<b>COC/5</b> Media unit, with whiteboard, poseur	7172	7416	7710	7906	8248	8492	8932	9420	10054	10640	10	
	<b>COC/1</b> High-back sofa	12416	12704	13050	13280	13684	13972	14490	15066	15814	16504	12	
	<b>2X COC/1</b> <b>Complete Media Booth</b> 2x COC/1 - HB Sofas + <b>1X COC/2</b> 1x COC/2 - Media Unit	24,832	25,408	26,100	26,560	27,368	27,944	28,980	30,132	31,628	33,008	31	
	<b>Total Cost</b>	<b>31,248</b>	<b>32,000</b>	<b>32,902</b>	<b>33,502</b>	<b>34,556</b>	<b>35,308</b>	<b>36,660</b>	<b>38,162</b>	<b>40,114</b>	<b>41,914</b>	<b>38</b>	

MEDIA UNIT

 Fabric Linear Yard  Leather Square Footage  Product Weight



## Range Information

- Front and rear panels can be upholstered in a wide range of fabrics
- Not available in leather or vinyl
- Rear panel available as a white board
- Steel frame powder coated to RAL 9016 white
- Polished aluminum legs Lockable silver castors



**POR/...  
MEDIA UNIT**

Code:	Description	COM /1	2	3	4	5	6	7	8	9	10	(ly)	(lb)
<b>POR/1</b>	Fully upholstered mobile media unit	5550	5650	5770	5850	5990	6090	6270	6470	6730	6970	4	
<b>POR/3</b>	Mobile media unit with whiteboard	5914	5990	6080	6140	6246	6322	6458	6608	6804	6984	3	



**DIMENSIONS**

Height: **1700mm (67")**  
 Width: **1300mm (51.25")**  
 Foot Depth: **710mm (28")**

Fabric Linear Yard Product Weight

**Connectivity as standard**

- External Power Unit includes:  
 1x US power socket  
 2x USB chargers  
 1x HDMI + USB TV input
- Internal power Unit  
 2x US power sockets
- Supports monitors from 40" to 48"
- VESA flat display mounting interface (FDMI) variant F
- Please Note:  
 TV/Monitor not supplied
- Not suitable for use with plasma TV's
- Other power options available
- Portal shelf is an optional extra - POA
- Not recommended to be upholstered in Grade 1 fabrics

MEDIA UNITS





**07.**

**Tables**



# ACDC

Height Adjustable Desks & Tables

boss



Designed to address the changing landscape of the workplace ACDC will transform the way you work.

The ACDC height adjustable table collection delivers benefits for the human body whilst promoting better working practice.



TABLES

ACDC offers the choice that will soon be the norm across both the workplace and home office landscapes.

The height adjustable collection includes a broad range of large meeting tables and fully ergonomic individual sit-stand desks. Promoting shorter standing group meetings and individual desk focused work.



## Height Adjustable Desking

### Table Tops

Available in three top sizes: 55", 63" and 71"

Height adjustable from 25" high at the lowest point to 50" at full extension.

**Table Tops are 0.75" MFC**

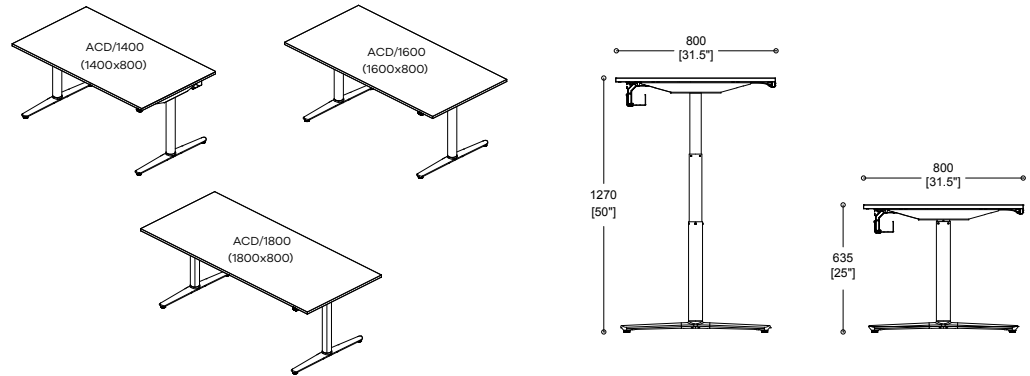

### Table Frame & Leg Finishes

#### Standard:

Black or white painted frame with Black, White or polished foot

Standard foot conforms to British Standard BS EN 527-2: 2016



Black RAL 9005 & Polished Aluminium

White RAL 9016 & Polished Aluminium

Black RAL 9005

White RAL 9016

### Linak Desk Control Components

As standard, ACDC Desking features a black or white DL11 lifting column and a DPF1K two button control panel.

To enhance the function of the desk, a DPF1C control panel with integrated LED & 3 memory positions is available. Additionally a bluetooth connector is available that allows you to control your desk via a free app

#### Standard Control Options

#### Optional Extras to Consider



DL11 Lifting Column in black or white

DPF1K 2 button table control panel

DPF1C with LED & 3 memory positions

Bluetooth Connector for remote desk control

### Boss Design Suggested Power & Data Options

Various power and data options are available to specify on ACDC Desking however we recommend the following shown (right) as standard options.

Additionally, power is located centre of the table and runs parallel with the longest edges.

For customers own power please contact us for compatibility



ARC-H LD  
Black or White

Pixel  
1x Power +TUF

Phase  
1x Power, 1x TUF

## Detailed Specification

### Leg Column, Frame & Foot Finishes

The ACDC Desking columns, frame and foot finishes are available in the following finishes:



Black RAL 9005 & Polished Aluminum

White RAL 9016 & Polished Aluminum

Black RAL 9005

White RAL 9016

### Frame/Top Height

ACDC Desking is 25" - 50" high including an 0.75" MFC table top.

Please note tolerances are within +/- 0.4"

### Top Finishes

Available with either square corners as standard or **optional 2.75" radius corner**.

### Screen Details

ACDC is available with both rear and side screen options, please see power page for the full range.

Side screens are **NOT** available on W55" tables.

### Table Power Suggestions

ACDC is available with the following power and data options:

- ARC-H LD
- Pixel
- Phase

Please see power page for full range.

A 78.75" starter cable is supplied as standard however other lengths are available.

If you wish to use an alternative power unit, please contact customer service for compatibility.

### Power Location

ACDC power locations are available central, left or right to the table and parallel to the longest edge. Positioning may vary depending on the type of power unit specified.

### Cable Management Options

As standard, ACDC design is specified with an OE QikTRAY under desk cable tray

### Digital Assets

We hold a library of assets for our Deploy product range which you can find by scanning the QR code below. If you are viewing our interactive PDF, simply click on the QR code to be taken directly there.



### Edge Details Square Edge

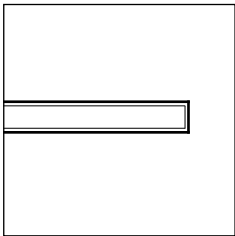

Side Profile

### 2.75" Radius Corners Optional

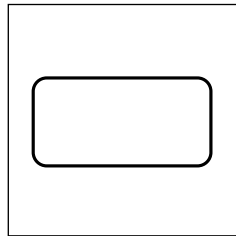

Plan View

### RAL Colors\* Standard Foot & Frame Finish Colors

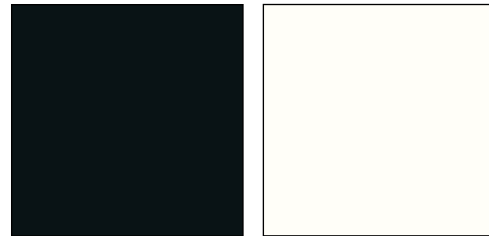

Black RAL 9005

White RAL 9016

\*Due to the printing process, colors are approximate. Please view an RAL color chart for accurate color representation

### Certification

ACDC Desking is certified to the following standard(s):

- **BS EN 527 - 2: 2016** - safety, strength and durability requirement for work tables and desks for office tasks to be undertaken in a seated, a sit-stand or standing position



## Standard Equipment

Our ACDC Desking system comes fully equipped with everything you need in order to start working from a sat or standing position.

To further enhance your sit stand working experience, we offer several upgrades & extras for you to choose from. Details of these can be found on the previous two pages.

Is there something you would like to add to your desk but haven't found an option for it here? Simply contact your sales representative who will be able to advise you on compatibility and costings.



Circular Column



DPF1K Control Panel

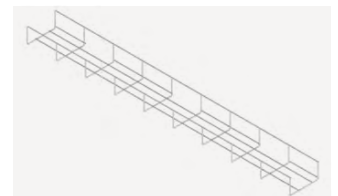

OE QikTRAY

### Product Certification

BS EN 527-2: 2016  
Office furniture. Work tables. Safety, strength and durability requirements

## Standard Power Options

We offer four power & data options as standard however others can be specified. Please see power page for more information.

### ARC-H LD

Black or white

### Pixel

1x Power & 1x TUF

### Phase

1x Power & 1x TUF





ARC-H LD  
Black or White



Pixel  
1x Power +TUF

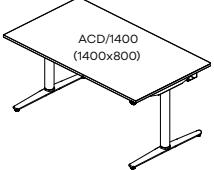
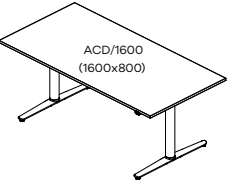
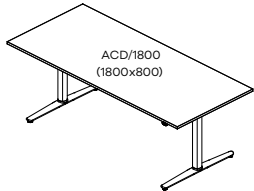

Phase  
1x Power, 1x TUF

HEIGHT ADJUSTABLE	Code:	Description	Size		Square Edge Only	Laminate	 (m <sup>2</sup> )	 (lb)
			L x W (" inches)		0.75"			
	<b>ACD/1400/P/B</b>	Polished Feet with Black under frame, Black Linak Lifting Column & Pathway Cable Management	55"	31.5"		2290	-	-
	<b>ACD/1400/P/W</b>	Polished Feet with White under frame, White Linak Lifting Column & Pathway Cable Management	55"	31.5"		2290	-	-
	<b>ACD/1400/B/B</b>	Black Feet with Black under frame, Black Linak Lifting Column & Pathway Cable Management	55"	31.5"		2338	-	-
	<b>ACD/1400/W/W</b>	White Feet with White under frame, White Linak Lifting Column & Pathway Cable Management	55"	31.5"		2338	-	-
	<b>ACD/1600/P/B</b>	Polished Feet with Black under frame, Black Linak Lifting Column & Pathway Cable Management	63"	31.5"		2334	-	-
	<b>ACD/1600/P/W</b>	Polished Feet with White under frame, White Linak Lifting Column & Pathway Cable Management	63"	31.5"		2334	-	-
	<b>ACD/1600/B/B</b>	Black Feet with Black under frame, Black Linak Lifting Column & Pathway Cable Management	63"	31.5"		2382	-	-
	<b>ACD/1600/W/W</b>	White Feet with White under frame, White Linak Lifting Column & Pathway Cable Management	63"	31.5"		2382	-	-
	<b>ACD/1800/P/B</b>	Polished Feet with Black under frame, Black Linak Lifting Column & Pathway Cable Management	71"	31.5"		2404	-	-
	<b>ACD/1800/P/W</b>	Polished Feet with White under frame, White Linak Lifting Column & Pathway Cable Management	71"	31.5"		2404	-	-
	<b>ACD/1800/B/B</b>	Black Feet with Black under frame, Black Linak Lifting Column & Pathway Cable Management	71"	31.5"		2452	-	-
	<b>ACD/1800/W/W</b>	White Feet with White under frame, White Linak Lifting Column & Pathway Cable Management	71"	31.5"		2452	-	-

Screen Type	Description L x W (")	COM /1	2	3	4	5	6	7	8	9	10	 (ly)
-------------	--------------------------	--------	---	---	---	---	---	---	---	---	----	--

### Rear Screens - Standard Height - 19.75" High

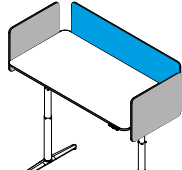
	<b>W49.5"</b> For 55" x 31.5" desks	298	342	394	428	488	532	610	696	808	910	
	<b>W57.5"</b> For 63" x 31.5" desks	316	362	416	452	516	562	644	734	852	960	
	<b>W65.5"</b> For 71" x 31.5" desks	368	418	478	518	588	638	728	828	958	1078	

### Side Screen - Standard Height - 19.75 High

	<b>H19.75" x W26"</b> Price Per Screen <b>N.B</b> Not available on 55"W Desks	202	228	258	278	314	340	386	436	502	562	
---	---	-----	-----	-----	-----	-----	-----	-----	-----	-----	-----	--

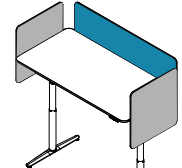

### Rear Screen - Modesty panel - 27.5" High

	<b>W49.5"</b> For 55" x 31.5" desks	360	440	536	600	712	792	936	1096	1304	1496	
	<b>W57.5"</b> For 63" x 31.5" desks	372	460	566	636	760	848	1006	1182	1410	1620	
	<b>W65.5"</b> For 71" x 31.5" desks	526	626	746	826	966	1066	1246	1446	1706	1946	

### Side Screen - Modesty Height - 27.5" High

	<b>H27.5" x W26"</b> Price Per Screen <b>N.B</b> Not available on 55"W Desks	250	296	350	386	450	496	578	668	786	894	
---	--	-----	-----	-----	-----	-----	-----	-----	-----	-----	-----	--

### Options

 Fabric Linear Yards  Product Weight

CODE:	DESCRIPTION	\$
<b>ARC-H LD</b>	Wireless charging - Black or White	260
<b>PIXEL</b>	1x Power & 1x TUF - White	385
<b>PHASE</b>	1x Power & 1x TUF - White or Black	400
<b>DPF1C</b>	LINAK DPF1C - Digital LED Control Panel	78

CODE:	DESCRIPTION	\$
<b>BLUE TOOTH</b>	Blue Tooth Adapter	66
<b>RC</b>	2.75" Radius corners	138

## Height Adjustable Meeting Tables

### Table Tops & Frame

Available in multiple top sizes: 63", 71", 82.75" and 94.5"

Height adjustable from 25.25" high at the lowest point to 45.25 at full extension.

Table Tops are 0.75" thick

### Standard Foot

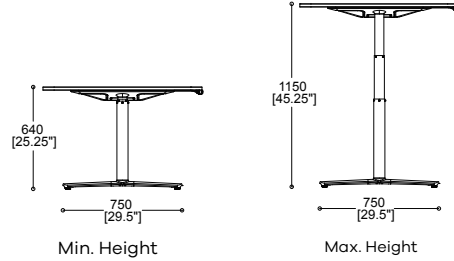

### Raised Foot

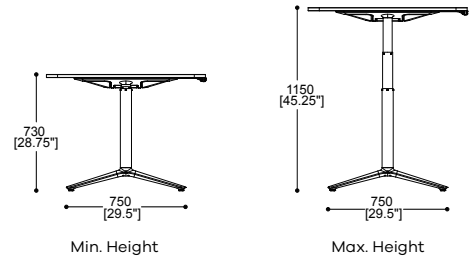

### Frame Options

#### Standard:

Polished Aluminum or Black painted RAL 9005 Under Frame with Black Cable Trays

#### Cable Management Option

For floor to power cable management, we recommend the use of Cable snake

See power and data section for more information



### Linak Desk Control Components

As standard, ACDC Desking features a black or white DL11 lifting column and a DPF1K two button control panel.

To enhance the function of the desk, a DPF1C control panel with integrated LED & 3 memory positions is available. Additionally a bluetooth connector is available that allows you to control your desk via a free app

### Standard Control Options



DL11 Lifting Column in black or white



DPF1K 2 button table control panel

### Optional Extras to Consider



DPF1C with LED & 3 memory positions



Bluetooth Connector for remote desk control

### Boss Design Suggested Power & Data Options

Various power and data options are available to specify on ACDC Desking however we recommend the following as standard: ARC-H LD, Pixel with TUF A&C.

As standard, power is located centre of the table and runs parallel with the longest edges.

For customers own power please contact us for compatibility



ARC-H LD  
Black or White



Pixel  
1x Power +TUF



Phase  
1x Power, 1x TUF

## Detailed Specification

### Leg Column, Frame & Foot Finishes

The ACDC Height Adjustable columns, frame and foot finishes are available in the following finishes:



Black RAL 9005 & Polished Aluminum

White RAL 9016 & Polished Aluminum

Black RAL 9005

White RAL 9016



Black RAL 9005 & Polished Aluminum

White RAL 9016 & Polished Aluminum

Black RAL 9005

White RAL 9016

Tables sized at W94.5"mm (94.5") and above feature a 'crossbar' above the foot for increased stability

### Frame Height

The ACDC Height Adjustable frame height varies depending on:

- Standard Foot: **25.25"**\*\* - **40.25" high** including table top.
- Raised Foot: **28.75"**\*\* - **45.25" high** including table top.
- **94.5" minimum height is 25.5"**.
- **94.5" minimum height is 27.25"**.

### Top Finishes

A choice of tops available as follows:

Standard Finishes - Laminate, Oak & ABW Veneer and Fenix. Available either with a square corner as standard or with an optional 2.75" radius corners.

### Edge Details

- 0.75" MF MDF - Matching color edge
- 0.75" Veneer - Solid Edge
- 0.75" Fenix - Matching Edge

### Grain Direction ←

Single table top pieces - Grain runs lengthways

### Meeting Table Power Options

ACDC is available with the following power and data options:

- ARC-H LD Unit
- Pixel - 1x Power & TUF

Please see page 524 for full specification

**A 78.75" starter cable is supplied as standard however other lengths are available.**

If you wish to use an alternative power unit, please contact customer service for compatibility.

### Power Location

ACDC power locations are available central, left or right to the table and parallel to the longest edge. Positioning may vary depending on the type of power unit specified.

### Digital Assets

We hold a library of assets for our Deploy product range which you can find by scanning the QR code below. If you are viewing our interactive PDF, simply click on the QR code to be taken directly there.



### Edge Details Square Edge

### 2.75" Radius Corners Optional

### RAL Colors\* Standard Finish Colors

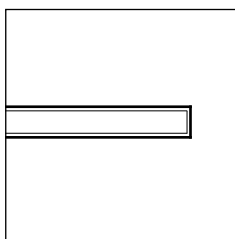

Side Profile

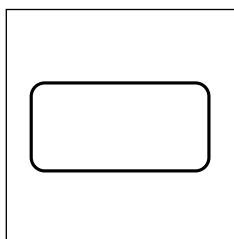

Plan View

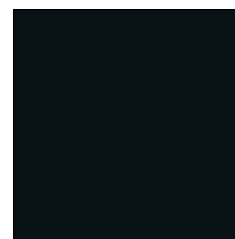

Black RAL 9005

White RAL 9016

\*Due to the printing process, colors are approximate. Please view an RAL color chart for accurate color representation

### Certification

ACDC (Standard Foot) is certified to the following standard(s):

- **BS EN 527 - 2: 2016** - safety, strength and durability requirement for work tables and desks for office tasks to be undertaken in a seated, a sit-stand or standing position

## Height Adjustable Meeting Tables - Standard Foot



Image Shows ACM/94.5"/L/P/W with Oak Veneer top in lowered position

### Standard Foot Table

#### Profiles

Height Adjustable from 25.25" - 45.25" the Flat foot specified

Square Edge as Standard

Flat foot is compliant to BS EN 527-2: 2016 - For Office tasks to be undertaken in a seated, sit-stand or standing position

Tables sized at W94.5" and above feature a 'crossbar' above the foot for increased stability



Black RAL 9005 & Polished Aluminm



White RAL 9016 & Polished Aluminm



Black RAL 9005



White RAL 9016

### Standard Equipment

Our ACDC meeting tables come fully equipped with everything you need in order to start working from a sat or standing position.

To further enhance your sit stand working experience, we offer several upgrades & extras for you to choose from. Details of these can be found on the previous two pages.

Is there something you would like to add to your desk but haven't found an option for it here? Simply contact your sales representative who will be able to advise you on compatibility and costings.

#### Standard Control Options



DL11 Lifting Column in black or white



DPF1K 2 button table control panel

#### Optional Extras to Consider



DPF1C with LED & 3 memory positions



Bluetooth Connector for remote desk control

STANDARD FOOT	Code	Description	Size L x W		Seats Approx.	Square Edge Only			 (lb)
						Laminate Matching Edge	Oak Or ABW Veneer Solid Edge	Fenix Matching Edge	
						0.75"	0.75"	0.75"	
Rectangular	<b>ACM/1600/L/P/B</b>	Polished Feet & Under Frame with Black Linak Lifting Column	63"	39.5"	6	3602	4320	4852	-
Rectangular	<b>ACM/1600/L/P/W</b>	Polished Feet & Under Frame with White Linak Lifting Column	63"	39.5"	6	3602	4320	4852	-
Rectangular	<b>ACM/1600/L/B</b>	Black Feet & Under Frame with Black Linak Lifting Column	63"	39.5"	6	3664	4380	4910	-
Rectangular	<b>ACM/1600/L/W</b>	White Feet & White Linak Lifting Column with Black Under Frame	63"	39.5"	6	3708	4424	4952	-
Rectangular	<b>ACM/1800R/L/P/B</b>	Polished Feet & Under Frame with Black Linak Lifting Column	71"	39.5"	6	3656	4452	4966	-
Rectangular	<b>ACM/1800R/L/P/W</b>	Polished Feet & Under Frame with White Linak Lifting Column	71"	39.5"	6	3656	4452	4966	-
Rectangular	<b>ACM/1800R/L/B</b>	Black Feet & Under Frame with Black Linak Lifting Column	71"	39.5"	6	3714	4506	5024	-
Rectangular	<b>ACM/1800R/L/W</b>	White Feet & White Linak Lifting Column with Black Under Frame	71"	39.5"	6	3756	4550	5068	-
Rectangular	<b>ACM/2100R/L/P/B</b>	Polished Feet & Underframe with Black Linak Actuator	82.75"	39.5"	6-8	4010	4582	5050	-
Rectangular	<b>ACM/2100R/L/P/W</b>	Polished Feet & Underframe with White Linak Actuator	82.75"	39.5"	6-8	4010	4582	5050	-
Rectangular	<b>ACM/2100R/L/B</b>	Black Feet & Underframe with Black Linak Actuator	82.75"	39.5"	6-8	4066	4642	5106	-
Rectangular	<b>ACM/2100R/L/W</b>	White Feet & White Linak Actuator with Black Underframe	82.75"	39.5"	6-8	4108	4686	5150	-
Rectangular	<b>ACM/2400R/L/P/B</b>	Polished Feet & Underframe with Black Linak Actuator	94.5"	39.5"	8	4482	4844	5206	-
Rectangular	<b>ACM/2400R/L/P/W</b>	Polished Feet & Underframe with White Linak Actuator	94.5"	39.5"	8	4482	4844	5206	-
Rectangular	<b>ACM/2400R/L/B</b>	Black Feet & Underframe with Black Linak Actuator	94.5"	39.5"	8	4538	4900	5264	-
Rectangular	<b>ACM/2400R/L/W</b>	White Feet & White Linak Actuator with Black Underframe	94.5"	39.5"	8	4582	4944	5308	-
Elliptical	<b>ACM/2400E/L/P/B</b>	Polished Feet & Underframe with Black Linak Actuator	94.5"	43.25"	8	4482	4844	5206	-
Elliptical	<b>ACM/2400E/L/P/W</b>	Polished Feet & Underframe with White Linak Actuator	94.5"	43.25"	8	4482	4844	5206	-
Elliptical	<b>ACM/2400E/L/B</b>	Black Feet & Underframe with Black Linak Actuator	94.5"	43.25"	8	4538	4900	5264	-
Elliptical	<b>ACM/2400E/L/W</b>	White Feet & White Linak Actuator with Black Underframe	94.5"	43.25"	8	4582	4944	5308	-
Lozenge	<b>ACM/2400D/L/P/B</b>	Polished Feet & Underframe with Black Linak Actuator	94.5"	39.5"	8	4482	4844	5206	-
Lozenge	<b>ACM/2400D/L/P/W</b>	Polished Feet & Underframe with White Linak Actuator	94.5"	39.5"	8	4482	4844	5206	-
Lozenge	<b>ACM/2400D/L/B</b>	Black Feet & Underframe with Black Linak Actuator	94.5"	39.5"	8	4538	4900	5264	-
Lozenge	<b>ACM/2400D/L/W</b>	White Feet & White Linak Actuator with Black Underframe	94.5"	39.5"	8	4582	4944	5308	-

TABLES

 Product Weight

**Options**

CODE:	DESCRIPTION	\$
<b>CUTOUT</b>	Cut out for customers own power	106
<b>ARC-H LD</b>	Wireless charging - Black or White	260
<b>PIXEL</b>	1x US Power & 1x TUF - White	385
<b>DPF1C</b>	LINAK DPF1C - Digital LED Control Panel	78

CODE:	DESCRIPTION	\$
<b>BLUE TOOTH</b>	Blue Tooth Adapter	66
<b>RC</b>	2.75" Radius corners	138

## Height Adjustable Meeting Tables - Raised Foot



Image Shows ACM/94.5"/E/H/B with Fenix top in raised position

### Raised Foot Table Profiles

Height Adjustable from 25.25" - 45.25" the Flat foot specified

Square Edge as Standard

For table sizes over W94.5" and above feature a 'crossbar' above the foot for increased stability (shown above)



Black RAL 9005 & Polished Alminum



White RAL 9016 & Polished Alminum



Black RAL 9005



White RAL 9016

### Standard Equipment

Our ACDC meeting tables come fully equipped with everything you need in order to start working from a sat or standing position.

To further enhance your sit stand working experience, we offer several upgrades & extras for you to choose from. Details of these can be found on the previous two pages.

Is there something you would like to add to your desk but haven't found an option for it here? Simply contact your sales representative who will be able to advise you on compatibility and costings.

#### Standard Control Options



DL11 Lifting Column in black or white



DPF1K 2 button table control panel

#### Optional Extras to Consider



DPFIC with LED & 3 memory positions



Bluetooth Connector for remote desk control

RAISED FOOT	Code	Description	Size L x W		Seats Approx.	Square Edge Only			 (lb)
						Laminate Matching Edge	Oak Or ABW Veneer Solid Edge	Fenix Matching Edge	
						0.75"	0.75"	0.75"	
Rectangular	<b>ACM/1600/H/P/B</b>	Polished Feet & Under Frame with Black Linak Lifting Column	63"	39.5"	6	3646	4364	4894	-
Rectangular	<b>ACM/1600/H/P/W</b>	Polished Feet & Under Frame with White Linak Lifting Column	63"	39.5"	6	3646	4364	4894	-
Rectangular	<b>ACM/1600/H/B</b>	Black Feet & Under Frame with Black Linak Lifting Column	63"	39.5"	6	3704	4420	4952	-
Rectangular	<b>ACM/1600/H/W</b>	White Feet & White Linak Lifting Column with Black Under Frame	63"	39.5"	6	3748	4462	4996	-
Rectangular	<b>ACM/1800R/H/P/B</b>	Polished Feet & Under Frame with Black Linak Lifting Column	71"	39.5"	6	3694	4496	5010	-
Rectangular	<b>ACM/1800R/H/P/W</b>	Polished Feet & Under Frame with White Linak Lifting Column	71"	39.5"	6	3694	4496	5010	-
Rectangular	<b>ACM/1800R/H/B</b>	Black Feet & Under Frame with Black Linak Lifting Column	71"	39.5"	6	3752	4546	5068	-
Rectangular	<b>ACM/1800R/H/W</b>	White Feet & White Linak Lifting Column with Black Under Frame	71"	39.5"	6	3796	4590	5112	-
Rectangular	<b>ACM/2100R/H/P/B</b>	Polished Feet & Underframe with Black Linak Actuator	82.75"	39.5"	6-8	3884	4458	4922	-
Rectangular	<b>ACM/2100R/H/P/W</b>	Polished Feet & Underframe with White Linak Actuator	82.75"	39.5"	6-8	3884	4458	4922	-
Rectangular	<b>ACM/2100R/H/B</b>	Black Feet & Underframe with Black Linak Actuator	82.75"	39.5"	6-8	3956	4530	4996	-
Rectangular	<b>ACM/2100R/H/W</b>	White Feet & White Linak Actuator with Black Underframe	82.75"	39.5"	6-8	4000	4574	5040	-
Rectangular	<b>ACM/2400R/H/P/B</b>	Polished Feet & Underframe with Black Linak Actuator	94.5"	39.5"	8	4434	4796	5162	-
Rectangular	<b>ACM/2400R/H/P/W</b>	Polished Feet & Underframe with White Linak Actuator	94.5"	39.5"	8	4434	4796	5162	-
Rectangular	<b>ACM/2400R/H/B</b>	Black Feet & Underframe with Black Linak Actuator	94.5"	39.5"	8	4496	4860	5224	-
Rectangular	<b>ACM/2400R/H/W</b>	White Feet & White Linak Actuator with Black Underframe	94.5"	39.5"	8	4538	4904	5268	-
Elliptical	<b>ACM/2400E/H/P/B</b>	Polished Feet & Underframe with Black Linak Actuator	94.5"	43.25"	8	4476	4844	5206	-
Elliptical	<b>ACM/2400E/H/P/W</b>	Polished Feet & Underframe with White Linak Actuator	94.5"	43.25"	8	4476	4844	5206	-
Elliptical	<b>ACM/2400E/H/B</b>	Black Feet & Underframe with Black Linak Actuator	94.5"	43.25"	8	4538	4900	5264	-
Elliptical	<b>ACM/2400E/H/W</b>	White Feet & White Linak Actuator with Black Underframe	94.5"	43.25"	8	4582	4944	5308	-
Lozenge	<b>ACM/2400D/H/P/B</b>	Polished Feet & Underframe with Black Linak Actuator	94.5"	39.5"	8	4520	4888	5250	-
Lozenge	<b>ACM/2400D/H/P/W</b>	Polished Feet & Underframe with White Linak Actuator	94.5"	39.5"	8	4520	4888	5250	-
Lozenge	<b>ACM/2400D/H/B</b>	Black Feet & Underframe with Black Linak Actuator	94.5"	39.5"	8	4578	4940	5308	-
Lozenge	<b>ACM/2400D/H/W</b>	White Feet & White Linak Actuator with Black Underframe	94.5"	39.5"	8	4622	4982	5350	-

TABLES

 Product Weight

### Options

CODE:	DESCRIPTION	\$
<b>CUTOUT</b>	Cut out for customers own power	106
<b>ARC-H LD</b>	Wireless charging - Black or White	260
<b>PIXEL</b>	1x US Power & 1x TUF - White	385
<b>DPF1C</b>	LINAK DPF1C - Digital LED Control Panel	78

CODE:	DESCRIPTION	\$
<b>BLUE TOOTH</b>	Blue Tooth Adapter	66
<b>RC</b>	2.75" Radius corners	138

# Agent

Tables

boss



With versatility at its core, the Agent table collection is available in a variety of height, sizes and finishes. Robust and refined, these hard-working pieces are as agile as they are functional.

Ideal for collaboration, meetings and breakout areas, the range is highly customisable with various power, data and cable management options. Available in American Black Walnut or Oak, personalise with painted frames in a range of colors.





## Agent 4 Leg Tables

A complete and detailed list of sizes and specifications can be viewed by scanning the QR code below.

If you are viewing this digitally, simply click the QR code below.



## Agent Coding System

To make ordering your Agent table as easy as possible, we have constructed a simple chart that will help you build your table codes

Table	Length	Width	Underframe	Top Finish	Top Material
DT Dining Table	NUM inch figure	NUM inch figure	Oak Oak	Oak Oak	VEN Veneered Top
			ABW American Black Walnut	ABW American Black Walnut	
				Color Finish Color of Top	HPL High Pressure Laminate

4 LEG DINING HEIGHT	Code:	Size			No. of Tops	Square Edge Only			(lb)
		L x W x H				Oak Veneer 0.75"	ABW Veneer 0.75"	HP Laminate 0.75"	
OAK Under Frame	AGE/DT/1800/600/OAK/...	71"	23.25"	29.25"	1	4094	-	4542	-
	AGE/DT/1800/800/OAK/...	71"	31.5"	29.25"	1	4226	-	4634	-
	AGE/DT/1800/1000/OAK/...	71"	39.25"	29.25"	1	4452	-	4722	-
	AGE/DT/1800/1200/OAK/...	71"	47.25"	29.25"	1	4750	-	4822	-
OAK Under Frame	AGE/DT/2000/600/OAK/...	78.75"	23.25"	29.25"	1	4896	-	5104	-
	AGE/DT/2000/800/OAK/...	78.75"	31.5"	29.25"	1	4988	-	5192	-
	AGE/DT/2000/1000/OAK/...	78.75"	39.25"	29.25"	1	5232	-	5290	-
	AGE/DT/2000/1200/OAK/...	78.75"	47.25"	29.25"	1	5364	-	5390	-
OAK Under Frame	AGE/DT/2200/600/OAK/...	86.75"	23.25"	29.25"	1	5350	-	5314	-
	AGE/DT/2200/800/OAK/...	86.75"	31.5"	29.25"	1	5438	-	5406	-
	AGE/DT/2200/1000/OAK/...	86.75"	39.25"	29.25"	1	5600	-	5564	-
	AGE/DT/2200/1200/OAK/...	86.75"	47.25"	29.25"	1	5716	-	5664	-
OAK Under Frame	AGE/DT/2400/600/OAK/...	94.5"	23.25"	29.25"	1	5564	-	5468	-
	AGE/DT/2400/800/OAK/...	94.5"	31.5"	29.25"	1	5702	-	5604	-
	AGE/DT/2400/1000/OAK/...	94.5"	39.25"	29.25"	1	5790	-	5696	-
	AGE/DT/2400/1200/OAK/...	94.5"	47.25"	29.25"	1	5862	-	5760	-
ABW Under Frame	AGE/DT/1800/600/ABW/...	71"	23.25"	29.25"	1	-	4504	4904	-
	AGE/DT/1800/800/ABW/...	71"	31.5"	29.25"	1	-	4668	5026	-
	AGE/DT/1800/1000/ABW/...	71"	39.25"	29.25"	1	-	4910	5152	-
	AGE/DT/1800/1200/ABW/...	71"	47.25"	29.25"	1	-	5234	5274	-
ABW Under Frame	AGE/DT/2000/600/ABW/...	78.75"	23.25"	29.25"	1	-	5210	5362	-
	AGE/DT/2000/800/ABW/...	78.75"	31.5"	29.25"	1	-	5302	5452	-
	AGE/DT/2000/1000/ABW/...	78.75"	39.25"	29.25"	1	-	5550	5574	-
	AGE/DT/2000/1200/ABW/...	78.75"	47.25"	29.25"	1	-	5710	5698	-
ABW Under Frame	AGE/DT/2200/600/ABW/...	86.75"	23.25"	29.25"	1	-	5654	5580	-
	AGE/DT/2200/800/ABW/...	86.75"	31.5"	29.25"	1	-	5742	5672	-
	AGE/DT/2200/1000/ABW/...	86.75"	39.25"	29.25"	1	-	5900	5826	-
	AGE/DT/2200/1200/ABW/...	86.75"	47.25"	29.25"	1	-	6040	5954	-
ABW Under Frame	AGE/DT/2400/600/ABW/...	94.5"	23.25"	29.25"	1	-	5910	5780	-
	AGE/DT/2400/800/ABW/...	94.5"	31.5"	29.25"	1	-	6046	5914	-
	AGE/DT/2400/1000/ABW/...	94.5"	39.25"	29.25"	1	-	6136	6006	-
	AGE/DT/2400/1200/ABW/...	94.5"	47.25"	29.25"	1	-	6200	6070	-

TABLES

Product Volume Inc. Packaging Product Weight

**Options**

CODE:	DESCRIPTION	\$
LINKING	Linking Clips - per set	162
STAINED	Color upcharge, Per Color per Order	380
-	Pathfinder - Dining height - See page 531	

CODE:	DESCRIPTION	\$
-	Customers Own Power & Data Cut out	106
-	Leather Cable Management Strap - available in Tan or black leather	92



## Agent 6 Leg Oak Tables

A complete and detailed list of sizes and specifications can be viewed by scanning the QR code below.

If you are viewing this digitally, simply click the QR code below.



## Agent Coding System

To make ordering your Agent table as easy as possible, we have constructed a simple chart that will help you build your table codes

Table	Length	Width	Underframe	Top Finish	Top Material
DT Dining Table	NUM inch figure	NUM inch figure	Oak Oak	Oak Oak	VEN Veneered Top
				Color Finish Color of Top	HPL High Pressure Laminate

6 LEG DINING HEIGHT	Code:	Size			No. of Tops	Square Edge Only			(lb)
		L	W	H		Oak Veneer 0.75"	ABW Veneer 0.75"	HP Laminate 0.75"	
OAK Frame	AGE/DT/2600/600/OAK/...	102.5"	23.25"	29.25"	2	7008	-	8164	
	AGE/DT/2600/800/OAK/...	102.5"	31.5"	29.25"	2	7234	-	8324	
	AGE/DT/2600/1000/OAK/...	102.5"	39.25"	29.25"	2	7614	-	8484	
	AGE/DT/2600/1200/OAK/...	102.5"	47.25"	29.25"	2	8124	-	8664	
OAK Frame	AGE/DT/2800/600/OAK/...	110.25"	23.25"	29.25"	2	7164	-	8348	
	AGE/DT/2800/800/OAK/...	110.25"	31.5"	29.25"	2	7396	-	8508	
	AGE/DT/2800/1000/OAK/...	110.25"	39.25"	29.25"	2	7784	-	8672	
	AGE/DT/2800/1200/OAK/...	110.25"	47.25"	29.25"	2	8304	-	8856	
OAK Frame	AGE/DT/3000/600/OAK/...	118"	23.25"	29.25"	2	7322	-	8526	
	AGE/DT/3000/800/OAK/...	118"	31.5"	29.25"	2	7556	-	8696	
	AGE/DT/3000/1000/OAK/...	118"	39.25"	29.25"	2	7954	-	8860	
	AGE/DT/3000/1200/OAK/...	118"	47.25"	29.25"	2	8482	-	9048	
OAK Frame	AGE/DT/3200/600/OAK/...	126"	23.25"	29.25"	2	7476	-	8708	
	AGE/DT/3200/800/OAK/...	126"	31.5"	29.25"	2	7718	-	8880	
	AGE/DT/3200/1000/OAK/...	126"	39.25"	29.25"	2	8124	-	9054	
	AGE/DT/3200/1200/OAK/...	126"	47.25"	29.25"	2	8664	-	9242	
OAK Frame	AGE/DT/3400/600/OAK/...	134"	23.25"	29.25"	2	7634	-	8892	
	AGE/DT/3400/800/OAK/...	134"	31.5"	29.25"	2	7878	-	9064	
	AGE/DT/3400/1000/OAK/...	134"	39.25"	29.25"	2	8294	-	9242	
	AGE/DT/3400/1200/OAK/...	134"	47.25"	29.25"	2	8842	-	9432	
OAK Frame	AGE/DT/3600/600/OAK/...	141.75"	23.25"	29.25"	2	7784	-	9070	-
	AGE/DT/3600/800/OAK/...	141.75"	31.5"	29.25"	2	8038	-	9248	-
	AGE/DT/3600/1000/OAK/...	141.75"	39.25"	29.25"	2	8464	-	9426	
	AGE/DT/3600/1200/OAK/...	141.75"	47.25"	29.25"	2	9024	-	9624	
OAK Frame	AGE/DT/3800/800/OAK/...	149.5"	31.5"	29.25"	2	9660	-	10572	
	AGE/DT/3800/1000/OAK/...	149.5"	39.25"	29.25"	2	10130	-	10772	
	AGE/DT/3800/1200/OAK/...	149.5"	47.25"	29.25"	2	10398	-	10978	
OAK Frame	AGE/DT/4000/800/OAK/...	157.5"	31.5"	29.25"	2	9862	-	10786	
	AGE/DT/4000/1000/OAK/...	157.5"	39.25"	29.25"	2	10338	-	10994	
	AGE/DT/4000/1200/OAK/...	157.5"	47.25"	29.25"	2	10612	-	11202	
OAK Frame	AGE/DT/4200/1000/OAK/...	165.25"	39.25"	29.25"	2	10772	-	11250	
	AGE/DT/4200/1200/OAK/...	165.25"	47.25"	29.25"	2	11004	-	11454	
OAK Frame	AGE/DT/4400/1000/OAK/...	173.25"	39.25"	29.25"	2	10994	-	11480	
	AGE/DT/4400/1200/OAK/...	173.25"	47.25"	29.25"	2	11226	-	11688	
OAK Frame	AGE/DT/4600/1000/OAK/...	181"	39.25"	29.25"	2	11212	-	11708	
	AGE/DT/4600/1200/OAK/...	181"	47.25"	29.25"	2	11450	-	11920	
OAK Frame	AGE/DT/4800/1200/OAK/...	189"	47.25"	29.25"	2	11508	-	11882	

TABLES

Product Volume Inc. Packaging Product Weight

**Options**

CODE:	DESCRIPTION	\$
LINKING	Linking Clips - per set	162
STAINED	Color upcharge, Per Color per Order	380
-	Pathfinder - Dining height - See page 531	

CODE:	DESCRIPTION	\$
-	Customers Own Power & Data Cut out	106
-	Leather Cable Management Strap - available in Tan or black leather	92

## 6 Leg Dining Tables - American Black Walnut



Image shown Agent 6 Leg Table with Black stained frame

### Agent 6 Leg ABW Tables

A complete and detailed list of sizes and specifications can be viewed by scanning the QR code below.

If you are viewing this digitally, simply click the QR code below.



### Agent Coding System

To make ordering your Agent table as easy as possible, we have constructed a simple chart that will help you build your table codes

Table	Length	Width	Underframe	Top Finish	Top Material
DT Dining Table	NUM inch figure	NUM inch figure	ABW American Black Walnut	ABW American Black Walnut	VEN Veneered Top
				Color Finish Color of Top	

6 LEG DINING HEIGHT	Code:	Size			No. of Tops	Square Edge Only			 (lb)
		L	W	H		Oak Veneer 0.75"	ABW Veneer 0.75"	HP Laminate 0.75"	
ABW Frame	AGE/DT/2600/600/ABW/...	102.5"	23.25"	29.25"	2	-	7744	8856	
	AGE/DT/2600/800/ABW/...	102.5"	31.5"	29.25"	2	-	8022	9074	
	AGE/DT/2600/1000/ABW/...	102.5"	39.25"	29.25"	2	-	8440	9292	
	AGE/DT/2600/1200/ABW/...	102.5"	47.25"	29.25"	2	-	8990	9516	
ABW Frame	AGE/DT/2800/600/ABW/...	110.25"	23.25"	29.25"	2	-	7914	9054	
	AGE/DT/2800/800/ABW/...	110.25"	31.5"	29.25"	2	-	8200	9276	
	AGE/DT/2800/1000/ABW/...	110.25"	39.25"	29.25"	2	-	8628	9504	
	AGE/DT/2800/1200/ABW/...	110.25"	47.25"	29.25"	2	-	9192	9728	
ABW Frame	AGE/DT/3000/600/ABW/...	118"	23.25"	29.25"	2	-	8088	9248	
	AGE/DT/3000/800/ABW/...	118"	31.5"	29.25"	2	-	8378	9480	
	AGE/DT/3000/1000/ABW/...	118"	39.25"	29.25"	2	-	8816	9708	
	AGE/DT/3000/1200/ABW/...	118"	47.25"	29.25"	2	-	9392	9936	
ABW Frame	AGE/DT/3200/600/ABW/...	126"	23.25"	29.25"	2	-	8258	9446	
	AGE/DT/3200/800/ABW/...	126"	31.5"	29.25"	2	-	8558	9682	
	AGE/DT/3200/1000/ABW/...	126"	39.25"	29.25"	2	-	9004	9914	
	AGE/DT/3200/1200/ABW/...	126"	47.25"	29.25"	2	-	9594	10150	
ABW Frame	AGE/DT/3400/600/ABW/...	134"	23.25"	29.25"	2	-	8432	9644	
	AGE/DT/3400/800/ABW/...	134"	31.5"	29.25"	2	-	8736	9882	
	AGE/DT/3400/1000/ABW/...	134"	39.25"	29.25"	2	-	9192	10120	
	AGE/DT/3400/1200/ABW/...	134"	47.25"	29.25"	2	-	9788	10360	
ABW Frame	AGE/DT/3600/600/ABW/...	141.75"	23.25"	29.25"	2	-	8602	9838	-
	AGE/DT/3600/800/ABW/...	141.75"	31.5"	29.25"	2	-	8910	10084	-
	AGE/DT/3600/1000/ABW/...	141.75"	39.25"	29.25"	2	-	9378	10330	
	AGE/DT/3600/1200/ABW/...	141.75"	47.25"	29.25"	2	-	9990	10572	
ABW Frame	AGE/DT/3800/800/ABW/...	149.5"	31.5"	29.25"	2	-	10352	1186	
	AGE/DT/3800/1000/ABW/...	149.5"	39.25"	29.25"	2	-	10848	11436	
	AGE/DT/3800/1200/ABW/...	149.5"	47.25"	29.25"	2	-	1162	11692	
ABW Frame	AGE/DT/4000/800/ABW/...	157.5"	31.5"	29.25"	2	-	10562	11414	
	AGE/DT/4000/1000/ABW/...	157.5"	39.25"	29.25"	2	-	11068	11668	
	AGE/DT/4000/1200/ABW/...	157.5"	47.25"	29.25"	2	-	11386	11932	
ABW Frame	AGE/DT/4200/1000/ABW/...	165.25"	39.25"	29.25"	2	-	11446	11876	
	AGE/DT/4200/1200/ABW/...	165.25"	47.25"	29.25"	2	-	11718	12134	
ABW Frame	AGE/DT/4400/1000/ABW/...	173.25"	39.25"	29.25"	2	-	11678	12120	
	AGE/DT/4400/1200/ABW/...	173.25"	47.25"	29.25"	2	-	11960	12378	
ABW Frame	AGE/DT/4600/1000/ABW/...	181"	39.25"	29.25"	2	-	11910	12362	
	AGE/DT/4600/1200/ABW/...	181"	47.25"	29.25"	2	-	12200	12630	
ABW Frame	AGE/DT/4800/1200/ABW/...	189"	47.25"	29.25"	2	-	12278	12626	

TABLES

 Product Volume Inc. Packaging  Product Weight

Options

CODE:	DESCRIPTION	\$
LINKING	Linking Clips - per set	162
STAINED	Color upcharge, Per Color per Order	380
-	Pathfinder - Dining height - See page 531	

CODE:	DESCRIPTION	\$
-	Customers Own Power & Data Cut out	106
-	Leather Cable Management Strap - available in Tan or black leather	92



## Agent 4 Leg Tables

A complete and detailed list of sizes and specifications can be viewed by scanning the QR code below.

If you are viewing this digitally, simply click the QR code below.



## Agent Coding System

To make ordering your Agent table as easy as possible, we have constructed a simple chart that will help you build your table codes

Table	Length	Width	Underframe	Top Finish	Top Material
DT Dining Table	NUM inch figure	NUM inch figure	Oak Oak	Oak Oak	VEN Veneered Top
			ABW American Black Walnut	ABW American Black Walnut	
				Color Finish Color of Top	HPL High Pressure Laminate

4 LEG HIGH TABLE	Code:	Size			No. of Tops	Square Edge Only			(lb)
		L	W	H		Oak Veneer 0.75"	ABW Veneer 0.75"	HP Laminate 0.75"	
OAK Under Frame	AGE/HT/1800/600/OAK/...	71"	23.25"	41.25"	1	4206	-	4644	
	AGE/HT/1800/800/OAK/...	71"	31.5"	41.25"	1	4354	-	4748	
	AGE/HT/1800/1000/OAK/...	71"	39.25"	41.25"	1	4604	-	4852	
	AGE/HT/1800/1200/OAK/...	71"	47.25"	41.25"	1	4898	-	4956	
OAK Under Frame	AGE/HT/2000/600/OAK/...	78.75"	23.25"	41.25"	1	5120	-	5304	
	AGE/HT/2000/800/OAK/...	78.75"	31.5"	41.25"	1	5210	-	5392	
	AGE/HT/2000/1000/OAK/...	78.75"	39.25"	41.25"	1	5402	-	5446	
	AGE/HT/2000/1200/OAK/...	78.75"	47.25"	41.25"	1	5604	-	5608	
OAK Under Frame	AGE/HT/2200/600/OAK/...	86.75"	23.25"	41.25"	1	5600	-	5542	-
	AGE/HT/2200/800/OAK/...	86.75"	31.5"	41.25"	1	5688	-	5634	-
	AGE/HT/2200/1000/OAK/...	86.75"	39.25"	41.25"	1	5846	-	5794	
	AGE/HT/2200/1200/OAK/...	86.75"	47.25"	41.25"	1	6036	-	5968	
OAK Under Frame	AGE/HT/2400/600/OAK/...	94.5"	23.25"	41.25"	1	5898	-	5780	-
	AGE/HT/2400/800/OAK/...	94.5"	31.5"	41.25"	1	6034	-	5916	-
	AGE/HT/2400/1000/OAK/...	94.5"	39.25"	41.25"	1	6124	-	6006	-
	AGE/HT/2400/1200/OAK/...	94.5"	47.25"	41.25"	1	6190	-	6072	
ABW Under Frame	AGE/HT/1800/600/ABW/...	71"	23.25"	41.25"	1	-	4610	4988	
	AGE/HT/1800/800/ABW/...	71"	31.5"	41.25"	1	-	4772	5112	
	AGE/HT/1800/1000/ABW/...	71"	39.25"	41.25"	1	-	5318	5524	
	AGE/HT/1800/1200/ABW/...	71"	47.25"	41.25"	1	-	5646	5664	
ABW Under Frame	AGE/HT/2000/600/ABW/...	78.75"	23.25"	41.25"	1	-	5588	5714	-
	AGE/HT/2000/800/ABW/...	78.75"	31.5"	41.25"	1	-	5672	5806	
	AGE/HT/2000/1000/ABW/...	78.75"	39.25"	41.25"	1	-	5926	5926	
	AGE/HT/2000/1200/ABW/...	78.75"	47.25"	41.25"	1	-	6146	6106	
ABW Under Frame	AGE/HT/2200/600/ABW/...	86.75"	23.25"	41.25"	1	-	6078	5978	-
	AGE/HT/2200/800/ABW/...	86.75"	31.5"	41.25"	1	-	6164	6068	-
	AGE/HT/2200/1000/ABW/...	86.75"	39.25"	41.25"	1	-	6324	6224	
	AGE/HT/2200/1200/ABW/...	86.75"	47.25"	41.25"	1	-	6570	6458	
ABW Under Frame	AGE/HT/2400/600/ABW/...	94.5"	23.25"	41.25"	1	-	6482	6328	-
	AGE/HT/2400/800/ABW/...	94.5"	31.5"	41.25"	1	-	6620	6462	-
	AGE/HT/2400/1000/ABW/...	94.5"	39.25"	41.25"	1	-	6708	6552	-
	AGE/HT/2400/1200/ABW/...	94.5"	47.25"	41.25"	1	-	6776	6620	

TABLES

Product Volume Inc. Packaging Product Weight

**Options**

CODE:	DESCRIPTION	\$
LINKING	Linking Clips - per set	162
STAINED	Color upcharge, Per Color per Order	380
-	Customers Own Power & Data Cut out	106

CODE:	DESCRIPTION	\$
-	Leather Cable Management Strap - available in Tan or black leather	92

# Agent

6 Leg High Table - Oak

boss



## Agent 6 Leg Oak Tables

A complete and detailed list of sizes and specifications can be viewed by scanning the QR code below.

If you are viewing this digitally, simply click the QR code below.



## Agent Coding System

To make ordering your Agent table as easy as possible, we have constructed a simple chart that will help you build your table codes

Table	Length	Width	Underframe	Top Finish	Top Material
HT High Table	NUM inch figure	NUM inch figure	Oak Oak	Oak Oak	VEN Veneered Top
				Color Finish Color of Top	HPL High Pressure Laminate

6 LEG HIGH TABLE	Code:	Size			No. of Tops	Square Edge Only			 (lb)
		L	W	H		Oak Veneer 0.75"	ABW Veneer 0.75"	HP Laminate 0.75"	
OAK Frame	AGE/HT/2600/600/OAK/...	102.5"	23.25"	41.25"	2	7194	-	8344	
	AGE/HT/2600/800/OAK/...	102.5"	31.5"	41.25"	2	7442	-	8526	
	AGE/HT/2600/1000/OAK/...	102.5"	39.25"	41.25"	2	7868	-	8712	
	AGE/HT/2600/1200/OAK/...	102.5"	47.25"	41.25"	2	8374	-	8900	
OAK Frame	AGE/HT/2800/600/OAK/...	110.25"	23.25"	41.25"	2	7356	-	8526	
	AGE/HT/2800/800/OAK/...	110.25"	31.5"	41.25"	2	7606	-	8718	
	AGE/HT/2800/1000/OAK/...	110.25"	39.25"	41.25"	2	8042	-	8906	
	AGE/HT/2800/1200/OAK/...	110.25"	47.25"	41.25"	2	8562	-	9098	
OAK Frame	AGE/HT/3000/600/OAK/...	118"	23.25"	41.25"	2	7512	-	8712	
	AGE/HT/3000/800/OAK/...	118"	31.5"	41.25"	2	7770	-	8906	-
	AGE/HT/3000/1000/OAK/...	118"	39.25"	41.25"	2	8216	-	9102	-
	AGE/HT/3000/1200/OAK/...	118"	47.25"	41.25"	2	8750	-	9292	-
OAK Frame	AGE/HT/3200/600/OAK/...	126"	23.25"	41.25"	2	7674	-	8896	
	AGE/HT/3200/800/OAK/...	126"	31.5"	41.25"	2	7936	-	9098	
	AGE/HT/3200/1000/OAK/...	126"	39.25"	41.25"	2	8392	-	9292	
	AGE/HT/3200/1200/OAK/...	126"	47.25"	41.25"	2	8930	-	9490	
OAK Frame	AGE/HT/3400/600/OAK/...	134"	23.25"	41.25"	2	7834	-	9084	
	AGE/HT/3400/800/OAK/...	134"	31.5"	41.25"	2	8102	-	9286	
	AGE/HT/3400/1000/OAK/...	134"	39.25"	41.25"	2	8572	-	9486	
	AGE/HT/3400/1200/OAK/...	134"	47.25"	41.25"	2	9118	-	9690	
OAK Frame	AGE/HT/3600/600/OAK/...	141.75"	23.25"	41.25"	2	7994	-	9268	
	AGE/HT/3600/800/OAK/...	141.75"	31.5"	41.25"	2	8266	-	9472	
	AGE/HT/3600/1000/OAK/...	141.75"	39.25"	41.25"	2	8746	-	9682	
	AGE/HT/3600/1200/OAK/...	141.75"	47.25"	41.25"	2	9306	-	9888	
OAK Frame	AGE/HT/3800/800/OAK/...	149.5"	31.5"	41.25"	2	10136	-	11030	
	AGE/HT/3800/1000/OAK/...	149.5"	39.25"	41.25"	2	10508	-	11132	
	AGE/HT/3800/1200/OAK/...	149.5"	47.25"	41.25"	2	10910	-	11474	
OAK Frame	AGE/HT/4000/800/OAK/...	157.5"	31.5"	41.25"	2	10348	-	11252	
	AGE/HT/4000/1000/OAK/...	157.5"	39.25"	41.25"	2	10722	-	11360	
	AGE/HT/4000/1200/OAK/...	157.5"	47.25"	41.25"	2	11132	-	11704	
OAK Frame	AGE/HT/4200/1000/OAK/...	165.25"	39.25"	41.25"	2	11306	-	11768	
	AGE/HT/4200/1200/OAK/...	165.25"	47.25"	41.25"	2	11674	-	12124	
OAK Frame	AGE/HT/4400/1000/OAK/...	173.25"	39.25"	41.25"	2	11534	-	12004	
	AGE/HT/4400/1200/OAK/...	173.25"	47.25"	41.25"	2	11910	-	12370	
OAK Frame	AGE/HT/4600/1000/OAK/...	181"	39.25"	41.25"	2	11768	-	12244	
	AGE/HT/4600/1200/OAK/...	181"	47.25"	41.25"	2	12150	-	12620	
OAK Frame	AGE/HT/4800/1200/OAK/...	189"	47.25"	41.25"	2	12214	-	12590	

TABLES

 Product Volume Inc. Packaging  Product Weight

**Options**

CODE:	DESCRIPTION	\$
LINKING	Linking Clips - per set	162
STAINED	Color upcharge, Per Color per Order	380
-	Customers Own Power & Data Cut out	106

CODE:	DESCRIPTION	\$
-	Leather Cable Management Strap - available in Tan or black leather	92



Image shows Agent 6 Leg High Table

## Agent 6 Leg ABW Tables

A complete and detailed list of sizes and specifications can be viewed by scanning the QR code below.

If you are viewing this digitally, simply click the QR code below.



## Agent Coding System

To make ordering your Agent table as easy as possible, we have constructed a simple chart that will help you build your table codes

Table	Length	Width	Underframe	Top Finish	Top Material
HT High Table	NUM inch figure	NUM inch figure	ABW American Black Walnut	ABW American Black Walnut	VEN Veneered Top
				Color Finish Color of Top	HPL High Pressure Laminate

6 LEG HIGH TABLE	Code:	Size			No. of Tops	Square Edge Only			(lb)
		L	W	H		Oak Veneer 0.75"	ABW Veneer 0.75"	HP Laminate 0.75"	
ABW Frame	AGE/HT/2600/600/ABW/...	102.5"	23.25"	41.25"	2	-	7946	9034	
	AGE/HT/2600/800/ABW/...	102.5"	31.5"	41.25"	2	-	8230	9262	
	AGE/HT/2600/1000/ABW/...	102.5"	39.25"	41.25"	2	-	9168	10002	
	AGE/HT/2600/1200/ABW/...	102.5"	47.25"	41.25"	2	-	9734	10258	
ABW Frame	AGE/HT/2800/600/ABW/...	110.25"	23.25"	41.25"	2	-	8124	9236	
	AGE/HT/2800/800/ABW/...	110.25"	31.5"	41.25"	2	-	8414	9466	
	AGE/HT/2800/1000/ABW/...	110.25"	39.25"	41.25"	2	-	9376	10226	
	AGE/HT/2800/1200/ABW/...	110.25"	47.25"	41.25"	2	-	9950	10486	
ABW Frame	AGE/HT/3000/600/ABW/...	118"	23.25"	41.25"	2	-	8298	9436	
	AGE/HT/3000/800/ABW/...	118"	31.5"	41.25"	2	-	8598	9674	-
	AGE/HT/3000/1000/ABW/...	118"	39.25"	41.25"	2	-	9574	10450	-
	AGE/HT/3000/1200/ABW/...	118"	47.25"	41.25"	2	-	10170	10714	-
ABW Frame	AGE/HT/3200/600/ABW/...	126"	23.25"	41.25"	2	-	8478	9638	
	AGE/HT/3200/800/ABW/...	126"	31.5"	41.25"	2	-	8780	9878	
	AGE/HT/3200/1000/ABW/...	126"	39.25"	41.25"	2	-	9780	10670	
	AGE/HT/3200/1200/ABW/...	126"	47.25"	41.25"	2	-	10384	10940	
ABW Frame	AGE/HT/3400/600/ABW/...	134"	23.25"	41.25"	2	-	8652	9838	
	AGE/HT/3400/800/ABW/...	134"	31.5"	41.25"	2	-	8964	10084	
	AGE/HT/3400/1000/ABW/...	134"	39.25"	41.25"	2	-	9982	10894	
	AGE/HT/3400/1200/ABW/...	134"	47.25"	41.25"	2	-	10598	11168	
ABW Frame	AGE/HT/3600/600/ABW/...	141.75"	23.25"	41.25"	2	-	8830	10036	
	AGE/HT/3600/800/ABW/...	141.75"	31.5"	41.25"	2	-	9148	10290	
	AGE/HT/3600/1000/ABW/...	141.75"	39.25"	41.25"	2	-	10186	11116	
	AGE/HT/3600/1200/ABW/...	141.75"	47.25"	41.25"	2	-	10816	11396	
ABW Frame	AGE/HT/3800/800/ABW/...	149.5"	31.5"	41.25"	2	-	11152	11976	
	AGE/HT/3800/1000/ABW/...	149.5"	39.25"	41.25"	2	-	11638	12228	
	AGE/HT/3800/1200/ABW/...	149.5"	47.25"	41.25"	2	-	12080	12602	
ABW Frame	AGE/HT/4000/800/ABW/...	157.5"	31.5"	41.25"	2	-	11380	12224	
	AGE/HT/4000/1000/ABW/...	157.5"	39.25"	41.25"	2	-	11876	12472	
	AGE/HT/4000/1200/ABW/...	157.5"	47.25"	41.25"	2	-	12324	12860	
ABW Frame	AGE/HT/4200/1000/ABW/...	165.25"	39.25"	41.25"	2	-	12334	12760	
	AGE/HT/4200/1200/ABW/...	165.25"	47.25"	41.25"	2	-	12820	13236	
ABW Frame	AGE/HT/4400/1000/ABW/...	173.25"	39.25"	41.25"	2	-	12590	13018	
	AGE/HT/4400/1200/ABW/...	173.25"	47.25"	41.25"	2	-	13084	13504	
ABW Frame	AGE/HT/4600/1000/ABW/...	181"	39.25"	41.25"	2	-	12840	13280	
	AGE/HT/4600/1200/ABW/...	181"	47.25"	41.25"	2	-	13348	13776	
ABW Frame	AGE/HT/4800/1200/1050/ABW/...	189"	47.25"	41.25"	2	-	13494	13842	

TABLES

Product Volume Inc. Packaging Product Weight

Options

CODE:	DESCRIPTION	\$
LINKING	Linking Clips - per set	162
STAINED	Color upcharge, Per Color per Order	380
-	Customers Own Power & Data Cut out	106

CODE:	DESCRIPTION	\$
-	Leather Cable Management Strap - available in Tan or black leather	92



## Agent Desk

A complete and detailed list of sizes and specifications can be viewed by scanning the QR code below.

If you are viewing this digitally, simply click the QR code below.



## Agent Coding System

To make ordering your Agent table as easy as possible, we have constructed a simple chart that will help you build your table codes

Table	Length	Width	Underframe	Top Finish	Top Material
DESK Desk	NUM inch figure	NUM inch figure	Oak Oak	Oak Oak	VEN Veneered Top
			ABW American Black Walnut	ABW American Black Walnut	
			ABW American Black Walnut	Color Finish Color of Top	HPL High Pressure Laminate

AGENT DESK	Code:	Size			No. of Tops	Square Edge Only			 (lb)
		L	W	H		Laminate	Oak Veneer	ABW Veneer	
						0.75"	0.75"	0.75"	
OAK Under Frame	AGE/DESK/1000/700/OAK	39.25"	27.5"	29.25"		1334	1530	-	-
OAK Under Frame	AGE/DESK/1200/700/OAK	47.25"	27.5"	29.25"		1380	1590	-	-
ABW Under Frame	AGE/DESK/1000/700/ABW	39.25"	27.5"	29.25"		1496	-	1720	-
ABW Under Frame	AGE/DESK/1200/700/ABW	47.25"	27.5"	29.25"		1554	-	1790	-

 Product Volume Inc. Packaging  Product Weight

TABLES

### Options

CODE:	DESCRIPTION	\$	CODE:	DESCRIPTION	\$
STAINED	Color upcharge, Per Color per Order	272	-	Leather Cable Management Strap - available in Tan or black leather	92
-	Pathfinder - Dining height - See page 531				
-	Customers Own Power & Data Cut out	106			

# Agent Table Power & Data Locations

The Agent table range is compatible with a wide range of power and data units, however not every power and data unit can be used in all areas of the table. To help make specification easier for you, we have divided the tables up into color coded zones in which the listed power and data units can be

placed. Please note, the cross beams of the High Table may impede slightly on placement within zones 1,3,4 & 6 (blue) depending on what size of table you specify.

Power & Data Unit	Green Zones	Blue Zones	Yellow Zones
Pixel	•	•	-
Pivot	•	•	-
V-Dock	•	-	-
Pandora	•	-	-
Phase	-	-	•
Platinum	•	-	-
Prism	•	-	-

4 Leg High Table

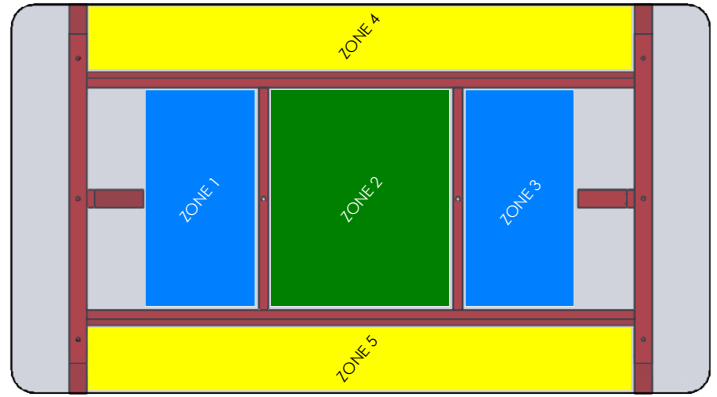

6 Leg High Table

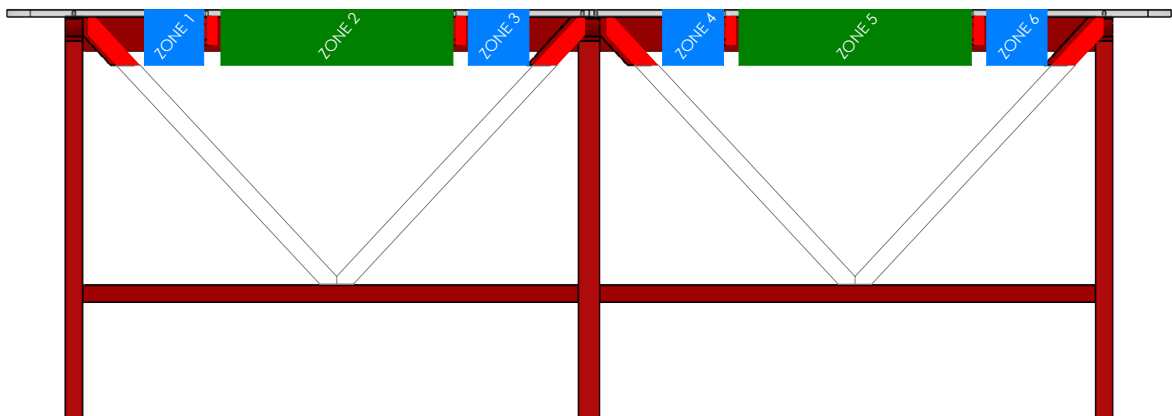
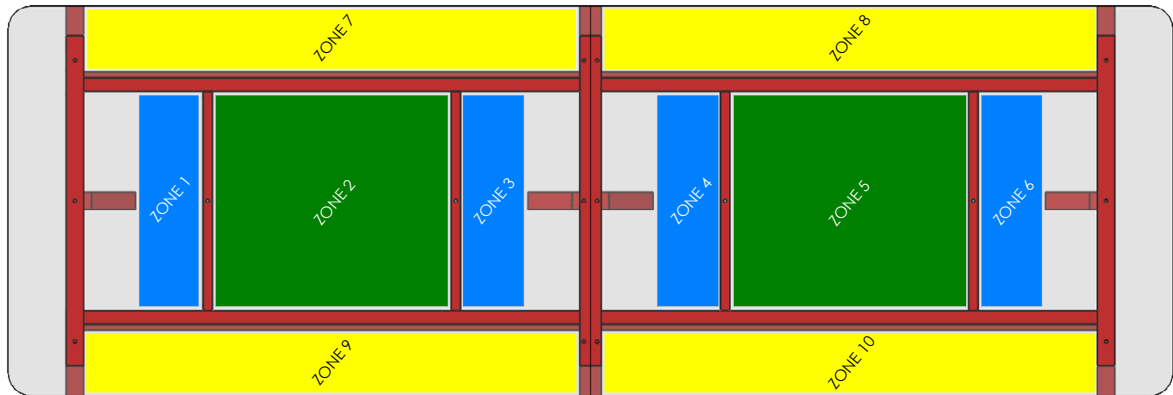

# Pre Configured Power Locations & Layout

Please note the list below is non exhaustive and is representative of popular locations our customers choose to specify the respective power and data units.

PHASE LAYOUT

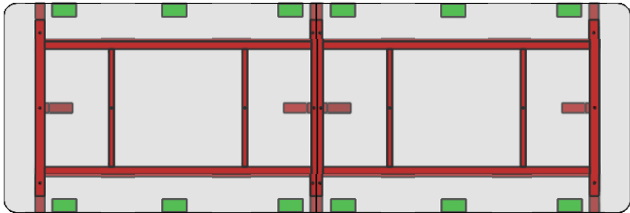

PLATINUM LAYOUT

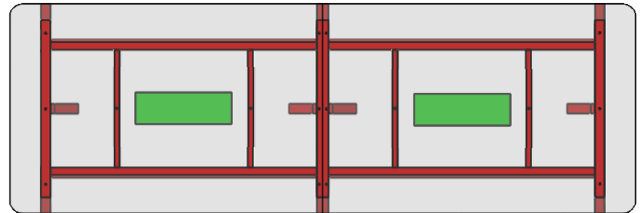

PANDORA LAYOUT

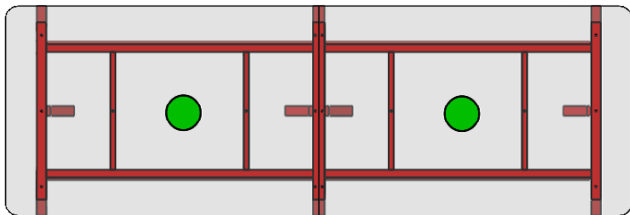

V - DOCK LAYOUT

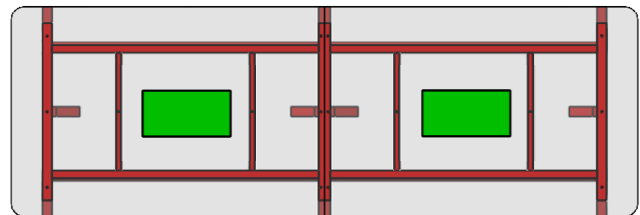

PRISM LAYOUT

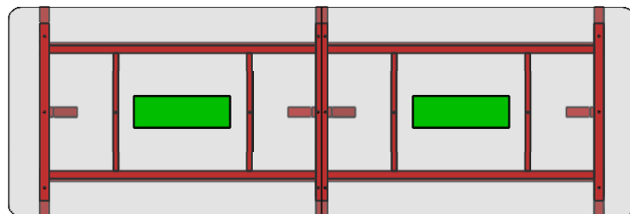

PIVOT 47 LAYOUT

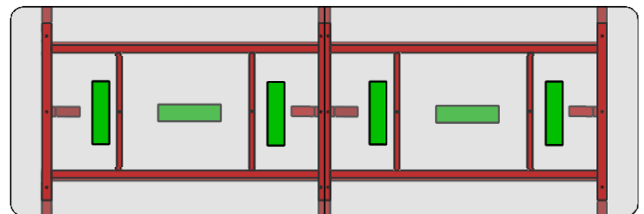

PIXEL LAYOUT

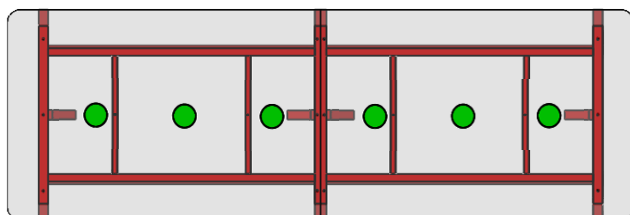

TABLES



## Agent Occasional Tables

A complete and detailed list of sizes and specifications can be viewed by scanning the QR code below.

If you are viewing this digitally, simply click the QR code below.

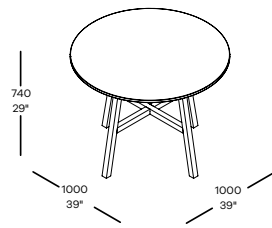

**Bistro Table**  
Square or Circular tops

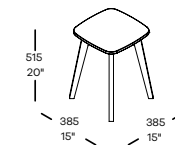
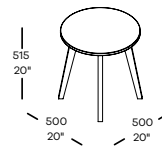

**Side Tables**  
Square or Circular tops

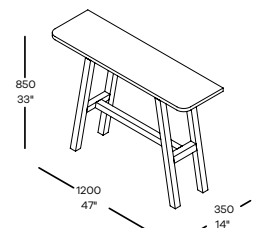







**Console Tables**

## Agent Coding System

To make ordering your Agent table as easy as possible, we have constructed a simple chart that will help you build your table codes

Table	Length	Width	Underframe	Top Finish	Top Material
<b>BT</b> Bistro Table	<b>NUM</b> inch figure	<b>NUM</b> inch figure	<b>Oak</b> Oak	<b>Oak</b> Oak	<b>VEN</b> Veneered Top
	<b>CIRC</b> Circular			<b>ABW</b> American Black Walnut	
<b>ST</b> Side Table	<b>SQ</b> Square		<b>ABW</b> American Black Walnut	<b>Color</b> Finish Color of Top	<b>HPL</b> High Pressure Laminate

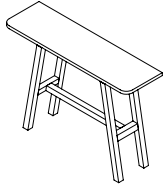
OCCASIONAL TABLES	Code:	Size L x W x H			Square Edge Only			 (lb)
					Oak Veneer 0.75"	ABW Veneer 0.75"	HP Laminate 0.75"	
<b>Agent Bistro Tables - Oak</b>								
	<b>BT/SQ/850/OAK/...</b>	SQ	33.5"	29.25"	2602	-	2972	-
	<b>BT/CIRC/850/OAK/...</b>	CIRC	33.5"	29.25"	2602	-	2972	-
	<b>BT/SQ/1000/OAK/...</b>	SQ	39.25"	29.25"	2864	-	3192	-
	<b>BT/CIRC/1000/OAK/...</b>	CIRC	39.25"	29.25"	2864	-	3192	-
<b>Agent Bistro Tables - ABW</b>								
	<b>BT/SQ/850/ABW/...</b>	SQ	33.5"	29.25"	-	3074	3454	-
	<b>BT/CIRC/850/ABW/...</b>	CIRC	33.5"	29.25"	-	3074	3454	-
	<b>BT/SQ/1000/ABW/...</b>	SQ	39.25"	29.25"	-	3398	3734	-
	<b>BT/CIRC/1000/ABW/...</b>	CIRC	39.25"	29.25"	-	3398	3734	-
<b>Agent Side Tables - Oak</b>								
	<b>ST/SQ/385/OAK/...</b>	SQ	15.25"	20.25"	POA	-	POA	-
	<b>ST/CIRC/500/OAK/...</b>	CIRC	19.75"	20.25"	POA	-	POA	-
<b>Agent Side Tables - ABW</b>								
	<b>ST/SQ/385/ABW/...</b>	SQ	15.25"	20.25"	-	POA	POA	-
	<b>ST/CIRC/500/ABW/...</b>	CIRC	19.75"	20.25"	-	POA	POA	-
<b>Agent Console Tables - Oak*</b>								
	<b>CT/1200/350/OAK/...</b>		47.25"	13.75"	33.5"	POA	-	POA
<b>Agent Console Tables - ABW*</b>								
	<b>CT/1200/350/ABW/...</b>		47.25"	13.75"	33.5"	-	POA	POA

TABLES

\* Agent Console Table is a non-free standing item and requires attachment to a wall.  
Table top thickness = 1"

 Product Volume Inc. Packaging  Product Weight

**Options**

CODE:	DESCRIPTION	\$	CODE:	DESCRIPTION	\$
	Color upcharge, Per Color per Order	272	-	Leather Cable Management Strap - available in Tan or black leather	92

# Atom

Tables

boss



The Atom table system is logical and elegant in its simplicity and is designed to work seamlessly with all elements of the upholstered Atom range.



TABLES

## Tables

### Table Tops

Available in three top shapes: Circular, Square and Rectangular  
Available in Laminate, MF MDF, Compact Laminate, Veneer and Fenix.

Table tops:  
0.5" (12mm) to 0.7" (18mm) thick  
across the range



### Table Frame & Leg Finishes

All frames are 28.5" (721mm) high  
excluding table top

#### Standard Frame Colors:

Black RAL 9005  
White RAL 9016  
Polished Aluminum



Black



White



Polished

### Power & Data Management Options

Power cut outs can be added as an option and are cut to the shape shown.

As standard, power is located centrally and runs parallel with the longest edges.

For customers own power please contact us for compatibility



ARC-H LD  
Black or White



Pixel  
1x Power +TUF

### Cable Management & Modesty Panels

#### Cable Management:

We recommend using QikTray

Power and Data is placed central and parallel to the longest edge



## Detailed Specification

### Legs & Frame

The ATOM legs & frame consist of aluminum components available in polished, or a Black or White painted finish

### Standard painted leg finishes:

- Polished Aluminum
- Black RAL 9005
- White RAL 9016

### Non - Standard frame & leg finishes:

- Other RAL colors - POA and subject to minimum order quantities

The ATOM frame is 28.5" (721mm) high without a top added. To find the total height of an ATOM table specification, please add the thickness from the edge details below.

### Top Finishes

A choice of tops available as follows:  
 Standard Finishes - Laminate, MF MDF, Compact Laminate,  
 Premium Finishes - Oak & ABW Veneer and Fenix.

### Edge Details

- 0.7" (18mm) Laminate - Matching color edge
- 0.5" (12mm) Compact Laminate - Black Edge
- 0.55" (14mm) Veneer - Solid Edge
- 0.55" (14mm) Fenix - Matching Edge

### Grain Direction ←

Single table top pieces - Grain runs lengthways  
 Two or more table top pieces - Grain runs widthways

### Table Power Options

Please see power & data page for the full list of compatible power options. If a power option is not listed, or you wish to use an alternative, then please contact Customer Service.

A 78.75" (2m) starter cable is supplied as standard however other lengths are available - see power & data for more information.

### Power Location

ATOM power locations are central to the table and parallel to the longest edge.

Seating guidelines are based on a seat width of 23.5" (600mm) from the edge of the table and are to be used as a guideline only.

For an accurate information specific to a chair in our range, please contact us or download the specific CAD files from our website.

### Digital Assets

We hold a library of assets for our Deploy product range which you can find by scanning the QR code below. If you are viewing our interactive PDF, simply click on the QR code to be taken directly there.



## Seating Guidelines

### Edge Details

#### Square Edge

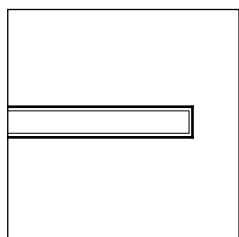

Side Profile

### RAL Colors\*

#### Standard Finish Colors

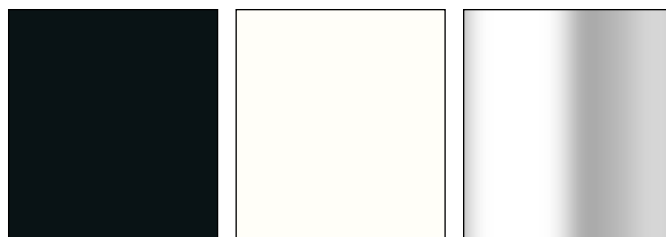

Black RAL 9005

White RAL 9016

Polished

\*Due to the printing process, colors are approximate. Please view an RAL color chart for accurate color representation



## Top Finish Options

Available in the following finishes:

**0.75" Laminate**  
Matching edge color

**0.75" MF-MDF**  
Matching edge color

**0.5" Compact Laminate**  
Black Edge



**0.5" Veneer**  
Solid Veneer Edge





**0.5" Fenix**  
Matching Edge





ATOM meeting tables feature inset middle table legs on tables with 6 legs or more (shown right).

A complete and detailed list of sizes and specifications can be viewed by scanning the QR code below



TOP SHAPE	Code	Size L x W (inches)		Seats Approx.	No. of Tops	Laminate - 0.75" Matching edge		Compact Laminate 0.5" Black Edge		Oak & ABW Veneer 0.5" Solid Edge		Fenix 0.5" Matching Edge		 (lb)
						Polished	Painted	Polished	Painted	Polished	Painted	Polished	Painted	
	ATM/C12	47.25 dia		4	1	3278	3876	4104	4702	3820	4414	4310	4908	
	ATM/C15	59 dia		4	1	3716	4314	4826	5420	4246	4844	4710	5308	

	ATM/S75	29.5	29.5	4	1	2982	3576	3296	3894	3674	4272	3536	4130	
	ATM/S8	31.5	31.5	4	1	3020	3618	3338	3932	3730	4328	3760	4354	
	ATM/S10	39.25	39.25	4	1	3204	3802	4178	4774	3948	4546	3970	4568	
	ATM/S12	47.25	47.25	4	1	3468	4066	4298	4896	4160	4754	4246	4844	
	ATM/S14	55	55	6	1	3932	4526	5046	5644	4568	5166	5170	5768	
	ATM/S15	59	59	8	1	3954	4552	5064	5662	4642	5240	5174	5768	
	ATM/S16	63	63	8	2	3984	4576	5088	5686	5626	6224	6544	7140	
	ATM/S18	70.75	70.75	8	2	4332	4930	5428	6026	6108	6702	6870	7464	
	ATM/S20	78.75	78.75	8	2	4720	5312	10894	11492	6314	6912	7288	7880	
	ATM/S24	94.5	94.5	10	2	6262	6860	11876	12470	7644	8242	8396	8990	

	ATM/R147	55	27.5	6	1	3296	3894	3936	4530	4058	4656	3992	4586	
	ATM/R1575	59	29.5	6	1	3326	3924	3962	4556	4108	4706	4036	4628	
	ATM/R168	63	31.5	8	1	3368	3966	4000	4598	4168	4766	4634	5232	
	ATM/R189	70.75	35.5	8	1	3562	4156	4186	4784	4436	5028	4814	5408	
	ATM/R2010	78.75	39.25	8	1	3902	4500	6796	7394	4568	5166	5050	5644	
	ATM/R2412	94.5	47.25	8	1	4822	5416	7334	7928	5274	5872	5648	6246	
	ATM/R2415	94.5	59	8	1	5588	6182	8082	8676	6414	7012	7236	7830	
	ATM/R3012	118	47.25	10	2	7700	8594	9932	10828	8806	9700	9072	9966	
	ATM/R3015	118	59	10	2	7894	8788	10112	11008	9266	10160	10336	11230	
	ATM/R3612	141.75	47.25	12	2	9782	10900	11992	13110	10840	11958	11330	12448	
	ATM/R3615	141.75	59	12	2	10052	11170	12242	13360	11786	12904	12276	13394	
	ATM/R4012	157.5	47.25	14	2	10116	11236	15746	16866	11050	12168	11438	12556	
	ATM/R4015	157.5	59	14	2	10392	11510	16000	17118	12026	13144	12168	13286	
	ATM/R4512	177.25	47.25	16	3	11236	12354	16306	17424	12668	13786	13076	14194	
	ATM/R4515	177.25	59	16	3	11510	12630	16564	17682	13360	14478	14960	16078	

TABLES

**Options**

 Fabric Linear Yard  Product Weight

CODE:	DESCRIPTION	\$
ARC-H LD	Wireless charging - Black or White	
PIXEL	1x US Power & 1x TUF	
	2x US Power, 1x HDMI & 1x TUF	

CODE:	DESCRIPTION	\$
POWER & DATA	Other options are available - see power page 524	-
CUTOUT	Cut out for customers own power	



## Range Information

- The Axis table is ideally suited to informal reception, atrium, meeting or breakout areas. An accompaniment to other collections from Boss Design, Axis features a slender polished aluminum 4-star base, with the choice of Laminate or veneered circular tops.
- Available as coffee, meeting or poseur height tables, they are suitable for a variety of uses.
- Polished aluminum 4 star base
- Choice of Laminate or veneered top
- Glides as standard



TOP SHAPE	Code:	Size L x H		Seats Approx.	Square OR Chamfered Edge			 (lb)
					Laminate 1"	Veneer 1"	Fenix 1"	
Circular	<b>AXT/1</b>	31.5" dia	15.75	2-4	2340	2406	3424	
Circular	<b>AXT/9</b>	39.25" dia	15.75	2-4	2420	2560	3638	
Circular	<b>AXT/5</b>	31.5" dia	29.25	2-4	2496	2568	3586	
Circular	<b>AXT/13</b>	39.25" dia	29.25	2-4	2578	2706	3792	
Circular	<b>AXT/7</b>	31.5" dia	41.25	2-4	2640	2712	3728	

 Product Weight



TABLE

### Options

CODE:	DESCRIPTION	\$
<b>AXT/1 GLASS TOP</b>	31.5" Glass top Available on Coffee Tables only	Same as Veneer

### Painted Frame Options

Color Choice	RAL 9005	RAL 9016	RAL 060 60 05	RAL 240 20 22	RAL 220 70 10	RAL 130 30 20	RAL 040 50 50	RAL 070 70 80
Suffix*	PF/B	PF/W	PF/SG	PF/DB	PF/LB	PF/GN	PF/CR	PF/Y
Coffee	100	100	100	100	100	100	100	100
Meeting	110	110	110	110	110	110	110	110
Poseur	120	120	120	120	120	120	120	120



# Deploy

Tables - Flip Top & Static

boss





Deploy is a flexible table range designed to fulfil a broad range of sizes and functional requirements you may have.

Available with a static table top or flip-top, as well as a multi-leg option.



# Deploy

## Tables - Flip Top & Static

boss

### Table Tops

Available in five table top shapes: Square, Rectangle, Barrel, Circular & Elliptical

Five standard finishes: Laminate, MF MDF, Veneer & Fenix. See appendix for Boss Design's standard colorways

Also available in a Poseur height configuration



Circular Flip Top



Standard or Poseur Height



Deploy Table Edge Linking

### Table Frame & Leg Finishes

#### Standard:

Black or Grey painted frame with polished foot/glide

#### Optional:

Black or Grey painted frame, foot & glide.

**N.B.** Flip Tops only available with polished foot. Powder coated RAL colors can be specified however you must be aware that there is a risk of chipping. Contact us for more details.



Single Grey frame & foot with polished leg & castors.



Single Black Leg, Foot & glides



Black frame & polished double leg with glides



Black frame & double leg with glides



Grey frame & Grey double leg with glides



Grey frame & Polished double leg with glides

### Cable Management & Modesty Panels

Deploy Flip Top tables are available with or without cable management, as shown right.

**N.B.** Modesty Panels cannot be used as a cable management tray due to the fact they feature one set of hook loops only (see right).



Cable Management



Modesty Panel

### Power & Data Management Options

Various power and data options are available to specify on Deploy so please **see page 524** for the full range available

As standard, power is located center of the table and runs parallel with the longest edges.

Drawings are provided for your reference prior to ordering and are to be used as a guide

For customers own power please contact us for compatibility



V-Dock recessed power module with matching flap



Pixel Power Unit - Surface Mounted

## Specification

### Legs & Frame

The Deploy consists of a painted steel frame, aluminum lower leg in either polished or optional matching painted finish.

### Standard frame finishes:

- Black RAL 9005
- Silver RAL 9006
- Standard lower leg/glides finishes
- Polished Aluminum

### Optional leg/glide finishes

**(Not available on flip top due to high risk of paint chipping)**

- Black - RAL 9005
- Silver - RAL 9006

### Legs Positioning

Deploy flip top tables have the option to specify either outset or inset legs at no additional charge.

### Foot Finish

Deploy is available with braked silver castors or polished/painted aluminum glides.

### Please Note:

- Deploy table with Glides is 29" (740mm) High
- Deploy table with Castors is 28.75" (730mm) High

### Table Top Detail

- 1" Across the whole range
- Laminate - Square Edge Only

- Square or Chamfered (chamfered available on static tables only):
- MF MDF (Melamine Faced Medium Density Fibreboard)
- Veneer
- Fenix
- Laminate

### Grain Direction ↔

- Single table top pieces - Grain runs lengthways
- Two or more table top pieces - Grain runs widthways

### Table Top Linking

- Linking is available in the following locations:
- Long Side (4 Links per table)
- Short side (4 Links per table)
- All Round Linking (8 links per table up to 78" (2000mm) tops - 10 per table if table length is over 78" (2000mm)

### Table Power Options

For centrally placed power on Deploy Flip Top tables please specify Pixel, Pivot & Powerbox, however please see power & data for the full list of power options. If a power option is not listed, or you wish to use an alternative, then please contact customer service.

A 78" (2m) starter cable is supplied as standard however other lengths are available - see power & data for more information.

### Seating Guidelines

Seating guidelines are based on a seat width of 23.5" (600mm) from the edge of the table and are to be used as a guideline only.

For an accurate information specific to a chair in our range, please contact us or download the specific CAD files from our website

### Deploy Digital Assets

We hold a library of assets for our Deploy product range which you can find by scanning the QR code below. If you are viewing our interactive PDF, simply click on the QR code to be taken directly there.



### PLEASE NOTE:

If using multiple Deploy Flip tables to create one large surface, linking units must be specified to ensure that the top surface remains level across joins. Minor tolerances in the manufacturing process can sometimes create minor height differences across multiple tables.

### Edge Details Square Edge

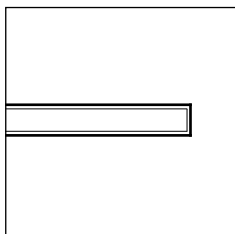

Side Profile

### Chamfered Edge Static Tables Only

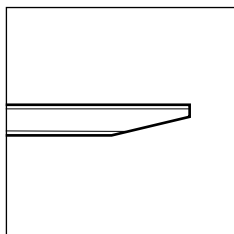

Side Profile

### 4" Radius Corners

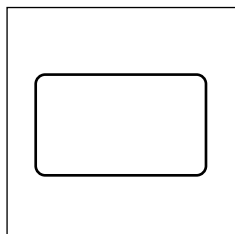

Plan View

### RAL Colors\* Standard Finish Colors

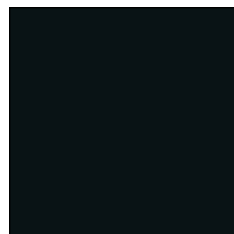

Black RAL 9005



Silver RAL 9006

\*Due to the printing process, colors are approximate. Please view an RAL color chart for accurate color representation

### Certification

Deploy is certified to the following standard(s):

- BS EN 16139 : 2013 - Furniture. Strength, durability and safety.



## Outset Leg

The smallest & largest line drawings for the Deploy Flip Top tables with Outset Legs are shown (right) for reference.

A complete and detailed list of sizes and specifications can be viewed by scanning the QR code below.

If you are viewing this digitally, simply click the QR code below.

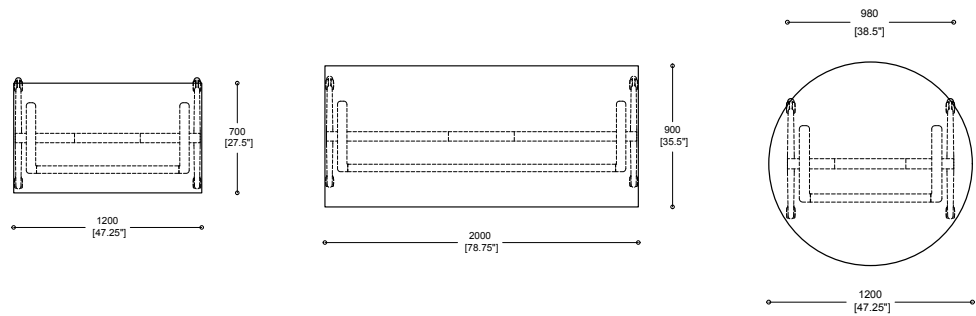

## Inset Leg

The smallest & largest line drawings for the Deploy Flip Top tables with Inset Legs are shown (right) for reference.

A complete and detailed list of sizes and specifications can be viewed by scanning the QR code below.

If you are viewing this digitally, simply click the QR code below.

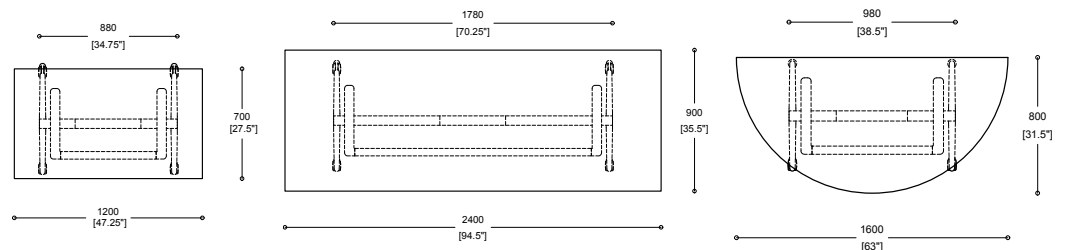

TABLE TOP SHAPE	Code:	Size L x W x H			Seats Approx.	No. of Tops	Square Edge Only			(lb)
							Laminate	Veneer	Fenix	
							1"	1"	1"	
Rectangle	DEP/F/R/107	39.25	27.5	29.25	4	1	2552	2944	2684	-
Rectangle	DEP/F/R/109	39.25	35.5	29.25	4	1	2618	3020	2754	-
Rectangle	DEP/F/R/127	47.25	27.5	29.25	4	1	2706	3096	2840	-
Rectangle	DEP/F/R/147	55	27.5	29.25	6	1	2798	3198	3000	-
Rectangle	DEP/F/R/1575	59	29.5	29.25	6	1	2816	3226	3010	-
Rectangle	DEP/F/R/168	63	31.5	29.25	6	1	3088	3318	3864	-
Rectangle	DEP/F/R/189	70.75	35.5	29.25	6	1	3138	3502	3910	-
Rectangle	DEP/F/R/209	78.75	35.5	29.25	8	1	3174	3626	3962	-
Rectangle	DEP/F/R/229	86.5	35.5	29.25	8	1	3288	3806	4140	-
Rectangle	DEP/F/R/249	94.5	35.5	29.25	10	1	3520	3814	4302	-
<b>Poseur Height - 1100mm</b>										
Rectangle	DEP/F/P/R/1575	59	29.5	43.25	4	1	2826	3240	3018	-
Rectangle	DEP/F/P/R/189	70.75	35.5	43.25	6	1	3238	3600	4002	-
Rectangle	DEP/F/P/R/209	78.75	35.5	43.25	8	1	3274	3720	4054	-
<b>Circular</b>										
Circular	DEP/F/C/10	39.25 Dia		29.25	4	1	2676	2742	3570	-
Circular	DEP/F/C/12	47.25 Dia		29.25	4	1	2816	2872	3622	-
Circular	DEP/F/C/14	55 Dia		29.25	4	1	2872	3102	3818	-
<b>Semi-Circular</b>										
Semi-Circular	DEP/F/SC/168	63	31.5	29.25	3	1	3056	3258	3888	-
Semi-Circular	DEP/F/SC/189	70.75	35.5	29.25	3	1	3096	3414	3930	-

Product Weight

TABLES



**Options**

CODE:	DESCRIPTION	\$
PF	Painted Frame Only Finishes RAL 9005 & RAL 9006	inc
LINKING LOCATIONS	Long Side	104
	Short Side	104
	All Round - 78.75" tables or less	206
	All Round - 78.75" table and larger	248
FEET	Lockable Silver Castors or Polished Glides	inc
CABLE MANAGEMENT	Cable Tray	172
	Modesty Panel	172
	Vertical Cable Management	90

CODE:	DESCRIPTION	\$
RAD 1	4" radius corners - Single top	306
CUT OUT	Cut out for customers own power & data	106
PIXEL	1x Power & TUF	210
POWERBOX	4 NEMA sockets, 15A OCP rocker switch, Female GST exit w/ cap - 108" HW NEMA cord	285
P&D	Power & Data Options - See power & data	-

<b>Product Certification</b>	BS EN 16139:2013 Furniture. Strength, durability and safety
------------------------------	---

# Deploy

Static Tables

boss



Image Shows Deploy Multi with black leg and frame, white Laminate top & Trinetic Task Chairs

## Multi Leg

Deploy Static tables above L118" feature a cable managed central leg (shown above & right).

A complete and detailed list of sizes and specifications can be viewed by scanning the QR code below.

If you are viewing this digitally, simply click the QR code below.

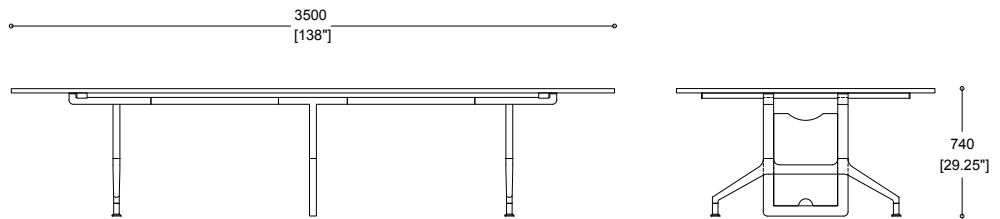

## Deploy Static Barrel

As part of the Deploy Static range we offer a Barrel shaped top profile (shown right). The sizings shown in the pricing table states the size of the table in the following format:

Table Length x Widest Width x Narrowest Width.

In the line drawing shown, this table is shown as:

W177" x W59" x W47.25"

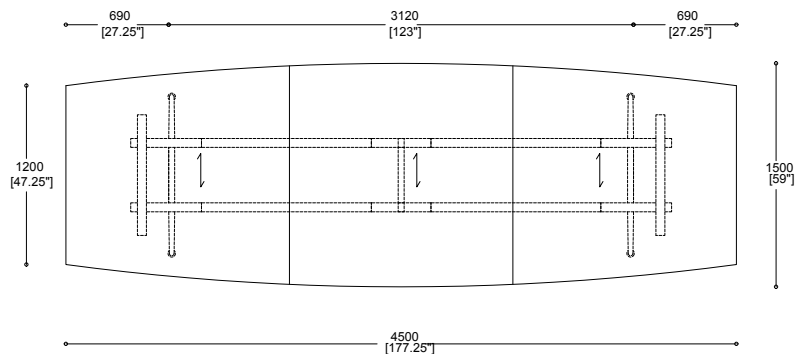



TABLE TOP SHAPE	Code:	Size L x W (all 29.25" High)		No. of Mid Legs	Seats Approx.	No. of Tops	Square OR Chamfered Edge			 (lb)	
							Laminate 1"	Veneer 1"	Fenix 1"		
NON-CABLE MANAGED LEG	Rectangle	DEP/S/R/127	47.25	27.5	N/A	4	1	2412	2784	2628	-
	Rectangle	DEP/S/R/147	55	27.5	N/A	6	1	2480	2852	2780	-
	Rectangle	DEP/S/R/1575	59	29.5	N/A	6	1	2472	2862	2770	-
	Rectangle	DEP/S/R/168	63	31.5	N/A	6	1	2724	2936	3616	-
	Rectangle	DEP/S/R/189	70.75	35.5	N/A	6	1	2760	3092	3648	-
	Rectangle	DEP/S/R/209	78.75	35.5	N/A	8	1	2752	3106	3654	-
	Rectangle	DEP/S/R/249	94.5	35.5	N/A	10	1	5102	5502	6202	-
	Rectangle (Double Leg)	DEP/S/R/2412	94.5	47.25	N/A	10	1	3262	3538	4238	-
	Rectangle (Double Leg)	DEP/S/R/3012	118	47.25	N/A	12	2	8166	9040	10452	-
	Rectangle (Double Leg)	DEP/S/R/3015	118	59	N/A	12	2	8700	9430	10502	-
CABLE MANAGED LEG	Rectangle (Double Leg)	DEP/S/R/3512	137.75	47.25	1	12	3	11004	11520	12858	-
	Rectangle (Double Leg)	DEP/S/R/3515	137.75	59	1	12	3	11294	12112	13190	-
	Rectangle (Double Leg)	DEP/S/R/4012	157.5	47.25	1	16	3	11560	12420	13484	-
	Rectangle (Double Leg)	DEP/S/R/4015	157.5	59	1	16	3	11546	12388	13364	-
	Rectangle (Double Leg)	DEP/S/R/4515	177.25	59	1	16	3	11920	12582	13980	-
	Rectangle (Double Leg)	DEP/S/R/5012	196.75	47.25	1	18	4	13832	14224	16694	-
	Rectangle (Double Leg)	DEP/S/R/5015	196.75	59	1	18	4	14606	14758	17264	-
	Rectangle (Double Leg)	DEP/S/R/5515	216.5	59	2	18	4	15766	16280	18414	-
	Rectangle (Double Leg)	DEP/S/R/6015	236.25	59	2	20	4	16050	16620	18710	-
<b>Barrel</b>		Dimensions show length, thickest width & narrowest width		L x TW x NW							
Barrel (Double Leg)	DEP/S/B/241512	94.5" x 59" x 47.25"		N/A	8	1	4674	5590	6290	-	
Barrel (Double Leg)	DEP/S/B/301512	118" x 59" x 47.25"		N/A	12	2	9656	10378	11450	-	
Barrel (Double Leg)	DEP/S/B/351512	137.75" x 59" x 47.25"		1	15	3	12720	13538	14610	-	
Barrel (Double Leg)	DEP/S/B/401512	157.5" x 59" x 47.25"		1	14	3	12964	13810	14780	-	
<b>Circular</b>											
Circular	DEP/S/C/15	59" dia		N/A	4	1	3520	3760	4504	-	

TABLES

**Options**

 Product Weight

CODE:	DESCRIPTION	\$
<b>PAINTED FRAMES PF</b>	Painted Frame Only Finishes RAL 9005 & RAL 9006	inc
	Black or Silver frame with polished foot & Glide	inc
	Single Leg Painted with Glides (per table)	194
	Double Leg Painted with Glides (per table)	154
<b>LINKING LOCATIONS</b>	Long Side	120
	Short Side	120
	All Round - 78.75" tables or less	234
	All Round - 78.75" table and larger	30
<b>FEET</b>	Lockable Silver Castors or Polished Glides	inc
<b>CABLE MANAGEMENT</b>	Cable Tray	172
	Modesty Panel	172
	Vertical Cable Management	90

CODE:	DESCRIPTION	\$
<b>RAD 1</b>	4" radius corners - Single top	306
<b>RAD 2</b>	4" radius corners - Double top	612
<b>CUT OUT</b>	Cut out for customers own power & data	106
<b>PIXEL</b>	1x Power & TUF A+C	210
<b>P&amp;D</b>	Power & Data Options - See power & data page 524	-

<b>Product Certification</b>	BS EN 16139:2013 Furniture. Strength, durability and safety
------------------------------	---

# Flamingo

Table

boss



## Range Information

- Aluminum stem and steel base, black or white painted base as standard
- Polished frame as standard - Fixed Height Only
- Felt protective pads on underside of base
- Black or white compact laminate top as standard
- Veneered or compact laminate top
- American Black Walnut or Oak veneer as standard
- Height adjustable base option only available in Black or White painted frame (not available in Polished)



**STATIC HEIGHT**

	Code:	Description:	Unit Size			\$	(lb)
			W	D	H		
	<b>FLT/P/L*</b>	Black or white compact laminate top, fixed height stem, white or black painted frame	450mm 17.75"	400mm 15.75"	630mm 24.75"	894	
	<b>FLT/P/W*</b>	American Black Walnut veneer top, fixed height stem, white or black painted frame	450mm 17.75"	400mm 15.75"	630mm 24.75"	1258	
	<b>FLT/P/O*</b>	Oak veneer top, fixed height stem, white or black painted frame	450mm 17.75"	400mm 15.75"	630mm 24.75"	1342	
	<b>FLT/C/L</b>	Black or white compact laminate top, fixed height polished frame	450mm 17.75"	400mm 15.75"	630mm 24.75"	1212	
	<b>FLT/C/W</b>	American Black Walnut veneer top, fixed height stem, polished frame	450mm 17.75"	400mm 15.75"	630mm 24.75"	1582	
	<b>FLT/C/O</b>	Oak veneer top, fixed height stem, polished stem	450mm 17.75"	400mm 15.75"	630mm 24.75"	1664	

TABLE

**Painted Frame Options**

Colour Choice	RAL 9005	RAL 9016	RAL 060 60 05	RAL 240 20 22	RAL 220 70 10	RAL 130 30 20	RAL 040 50 50	RAL 070 70 80
Suffix*	PF/B	PF/W	PF/SG	PF/DB	PF/LB	PF/GN	PF/CR	PF/Y
\$	Inc	Inc	300	300	300	300	300	300

**HEIGHT ADJUSTABLE**

	Code:	Description:	Unit Size			\$	(lb)
			W	D	H		
	<b>FLT/P/L/HA*</b>	Black or white compact laminate top Height Adjustable stem White or black painted frame	450mm 17.75"	400mm 15.75"	Min. 635mm 25" Max. 1085mm 42.75"	1062	
	<b>FLT/P/W/HA*</b>	American Black Walnut veneer top Height Adjustable stem White or black painted frame	450mm 17.75"	400mm 15.75"	Min. 635mm 25" Max. 1085mm 42.75"	1434	
	<b>FLT/P/O/HA</b>	Oak veneer top Height Adjustable stem White or black painted frame	450mm 17.75"	400mm 15.75"	Min. 635mm 25" Max. 1085mm 42.75"	1514	

Indi

Tables

boss



Designed by Broome Jenkins and engineered to Boss Design's exacting technical standards, Indi is an elegant table system that fits effortlessly into today's workplace. Designed to address the changing demands of the workplace.

One all-encompassing table range, enabling both individual and group work. Indi offers choice and style across the workplace.



## Tables

### Table Tops

Available in four top sizes: 63", 70.75", 82.75" and 94.5"

In three top shapes: Rectangular, elliptical and lozenge

Wooden Table Tops are 0.75" thick

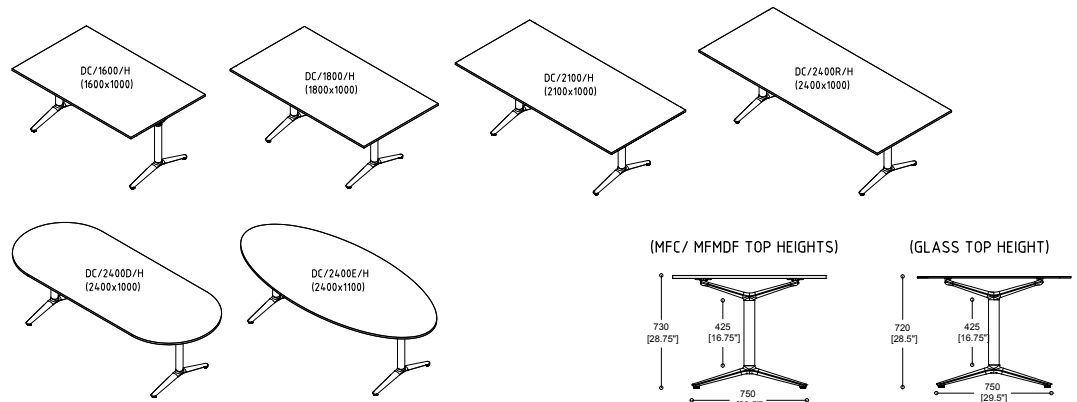

### Glass Table Tops

Available in three top sizes: 63", 70.75" and 82.75"

Available in Rectangular table tops only

Glass Table Tops are 0.5" thick



### Table Frame & Leg Finishes

#### Standard:

Black 9005 or White RAL 9016 painted leg with Black 9005, White RAL 9016 or polished raised foot

#### Optional:

Any of the standard Boss RAL colors for an additional upcharge



Black RAL 9005 & Polished Aluminum



Black RAL 9005



White RAL 9016 & Polished Aluminum



White RAL 9016



RAL 240 20 22



RAL 130 30 20



RAL 070 70 80



RAL 060 60 05



RAL 220 70 10



RAL 040 50 50

### Boss Design Suggested Power & Data Options

Various power and data options are available to specify on Indi Desking however we recommend the following as standard: ARC-H LD, Pixel with TUF A&C and Phase units.

As standard, power is located centre of the table and runs parallel with the longest edges.

For customers own power please contact us for compatibility

Power **NOT** available on glass tops



ARC-H LD  
Black or White



Pixel  
1x Power +TUF



Phase  
1x Power, 1x TUF

## Detailed Specification

### Leg Column, Frame & Foot Finishes

The Indi Static Meeting frame and foot finishes consist of aluminum components available in the following finishes:

#### Standard leg column and foot finish combinations:

- Polished Aluminum foot with Black RAL 9005
- Polished Aluminum foot with White RAL 9016
- Choice of 8 additional painted frame colors (see page opposite for full range of colors)

#### Non - Standard frame, leg & foot finishes:

- Other RAL colors - POA and subject to minimum order quantities

### Frame Height

The Indi Static table frame height varies depending on what foot option is specified:

- Standard Foot: **28.25" high** with a glass top added.
- Raised Foot: **28.25" high** with a glass top added.
- Standard Foot: **28.75" high** with an 0.75" top added.
- Raised Foot: **28.75" high** with an 0.75" top added.

**Please note tolerances are within +/- 10mm.**

### Top Finishes

A choice of tops available as follows:

Standard Finishes - 0.75" Laminate, MF MDF, Oak & ABW Veneer, Fenix and 0.5" clear glass. Available either with a square as standard or as an optional 2.75" radius edge.

### Edge Details

Available as a square edge as standard with 2.75" radius as an optional upgrade.

- 0.75" Laminate - Matching color edge
- 0.75" Veneer - Solid Edge
- 0.75" Fenix - Matching Edge
- 0.5" Glass top - Radius corners only

### Grain Direction ←

Single table top pieces - Grain runs lengthways

### Table Power Suggestions

Indi is available with the following power and data options:

- ARC-H LD
- Pixel
- Phase

Please see power and data page for full specification



Pixel



ARC-H LD



Phase

**A 78.75" starter cable is supplied as standard however other lengths are available.**

If you wish to use an alternative power unit, please contact customer service for compatibility.

### Power Location

ACDC power locations are available central, left or right to the table and parallel to the longest edge. Positioning may vary depending on the type of power unit specified. **No P&D available on glass options.**

### Digital Assets

We hold a library of assets for our Deploy product range which you can find by scanning the QR code below. If you are viewing our interactive PDF, simply click on the QR code to be taken directly there.



### Edge Details Square Edge

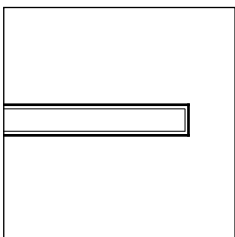

Side Profile

### 2.75" Radius Corners

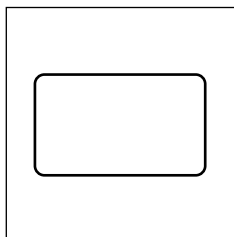

Plan View

### RAL Colors\* Standard Finish Colors

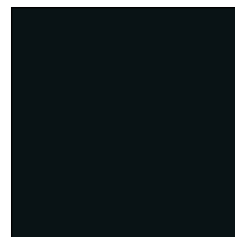

Black RAL 9005

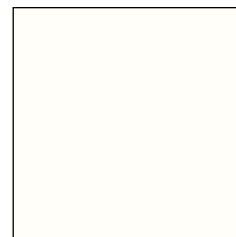

White RAL 9016

\*Due to the printing process, colors are approximate. Please view an RAL color chart for accurate color representation



Image shows Indi 2400 x 1000 table with Fenix 0754 Blue Fes top and RAL 040 50 50 frame

## Features

- Five top sizes
- Rectangular, elliptical & oval
- Laminate, Laminate, Veneer, Fenix
- Glass Top – rectangular only
- Power & data available
- Cable management solutions available
- Eight color frame options plus polished foot option
- Black frame with polished foot as standard
- Levelling feet



TOP SHAPE	Code	Description	Size		Seats Approx.	Square Edge Only			Clear Glass Top	 (lb)
			L	W		Laminate Matching Edge	Oak Or ABW Veneer Solid Edge	Fenix Matching Edge		
						0.75"	0.75"	0.75"	0.5"	
Rectangular	<b>IND/1600/H/P/B</b>	Polished High Feet & Black Frame	63"	39.25"	4	2788	3708	4236	3708	-
Rectangular	<b>IND/1600/H/B/B</b>	Black High Feet & Black Frame	63"	39.25"	4	2890	3810	4338	3810	-
Rectangular	<b>IND/1800/H/P/B</b>	Polished High Feet & Black Frame	70.75"	39.25"	4-6	2852	3848	4282	3848	-
Rectangular	<b>IND/1800/H/B/B</b>	Black High Feet & Black Frame	70.75"	39.25"	4-6	2954	3950	4384	3950	-
Rectangular	<b>IND/2100/H/P/B</b>	Polished High Feet & Black Frame	82.75"	39.25"	6	3720	4240	4666	4240	-
Rectangular	<b>IND/2100/H/B/B</b>	Black High Feet & Black Frame	82.75"	39.25"	6	3822	4342	4768	4342	-
Rectangular	<b>IND/2400R/H/P/B</b>	Polished High Feet & Black Frame	94.5"	39.25"	8	3832	4352	4776	N/A	-
Rectangular	<b>IND/2400R/H/B/B</b>	Black High Feet & Black Frame	94.5"	39.25"	8	3934	4452	4878	N/A	-
Elliptical	<b>IND/2400E/H/P/B</b>	Polished High Feet & Black Frame	94.5"	39.25"	8	4138	4758	5270	N/A	-
Elliptical	<b>IND/2400E/H/B/B</b>	Black High Feet & Black Frame	94.5"	39.25"	8	4240	4862	5372	N/A	-
Lozenge	<b>IND/2400D/H/P/B</b>	Polished High Feet & Black Frame	94.5"	39.25"	8	4138	4758	5270	N/A	-
Lozenge	<b>IND/2400D/H/B/B</b>	Black High Feet & Black Frame	94.5"	39.25"	8	4240	4862	5372	N/A	-

TABLES

 Product Weight

### Options

CODE:	DESCRIPTION	\$
<b>ARC-H LD</b>	Wireless charging - Gray or White	260
<b>PIXEL</b>	1x Power & 1x TUF - White	385
<b>PHASE</b>	1x Power & 1x TUF - White or Black	400
<b>RC</b>	2.75" Radius corners (Glass tops have radius corners as standard)	106
<b>CUT OUT</b>	Cut out for customers own power	106

### Painted Frame Options

Color Choice	RAL 9005	RAL 9016	RAL 060 60 05	RAL 240 20 22	RAL 220 70 10	RAL 130 30 20	RAL 040 50 50	RAL 070 70 80
Suffix*	B	W	SG	DB	LB	GN	CR	Y
+\$	Inc	Inc	900	900	900	900	900	900





## Range Information

- Available with an Oak or American Black Walnut Underframe
- Three standard sizes  
(41.25" x 41.25" / 69 x 41.25" / 92.5" x 41.25")



**SQUARE TABLE**

	Code:	Description	\$	 (lb)
 <p><b>DIMENSIONS</b> Height: <b>750mm (30")</b> Width: <b>1050mm (41")</b> Depth: <b>1050mm (41")</b></p>	ISL/T/1050/OAK	Square 41.25" x 41.25" (1050 x 1050mm) Table, Oak frame (As Shown)	2626	
	ISL/T/1050/ABW	Square 41.25" x 41.25" (1050 x 1050mm) Table, ABW frame	2872	

**RECTANGULAR TABLE**

	Code:	Description	\$	 (lb)
 <p><b>DIMENSIONS</b> Height: <b>750mm (30")</b> Width: <b>1750mm (69")</b> Depth: <b>1050mm (41")</b></p>	ISL/T/1750/OAK	Rectangular 69 x 41.25" (1750 x 1050mm) Table, Oak frame	3140	
	ISL/T/1750/ABW	Rectangular 69 x 41.25" (1750 x 1050mm) Table, ABW frame (As Shown)	3442	

**LARGE RECTANGULAR TABLE**

	Code:	Description	\$	 (lb)
 <p><b>DIMENSIONS</b> Height: <b>750mm (30")</b> Width: <b>2350mm (93")</b> Depth: <b>1050mm (41")</b></p>	ISL/T/2350/OAK	Rectangular 92.5" x 41.25" (2350 x 1050mm) Table, Oak frame	3698	
	ISL/T/2350/ABW	Rectangular 92.5" x 41.25" (2350 x 1050mm) Table, ABW frame (As Shown)	4046	

TABLES

**Product Certification**  
BS EN 15372:2016 - Level 2



## Range Information

- Part of the striking and distinguished Kruze collection, the complementary table range will grace any meeting, dining or breakout area.
- Standing on a distinctive, polished aluminum 4-star base, the table top is available as circular or square and in several finishes including glass, laminated and veneered.
- Polished aluminum 4 star base with glides
- Choice of Laminate, Veneer & Fenix tops
- 3 heights are available: coffee, meeting and poseur
- Complements the Kruze range of seating
- 31.5" (800mm) Glass Top available on coffee table height only



TOP SHAPE	Code:	Size L x W x H		Seats Approx.	Square OR Chamfered Edge			 (lb)
					Laminate 1"	Veneer 1"	Fenix 1"	
Circular	<b>KRTC/C8</b>	31.5" dia	15.75"	2-4	1962	2016	2894	
Square	<b>KRTC/S8</b>	31.5"	31.5"	15.75"	2-4	1766	1904	1952
Circular	<b>KRTM/C8</b>	31.5" dia	29"	2-4	2102	2154	3036	
Square	<b>KRTM/S8</b>	31.5"	31.5"	29"	2-4	1890	2028	2070
Circular	<b>KRTP/C8</b>	31.5" dia	41.25"	2-4	2190	2248	3124	

 Product Weight



TABLE

### Options

CODE:	DESCRIPTION	\$
<b>GLASS TOP</b>	31.5" Glass top Available on Coffee Tables only	Same price as Laminate

### Painted Frame Options



Color Choice	RAL 9005	RAL 9016	RAL 060 60 05	RAL 240 20 22	RAL 220 70 10	RAL 130 30 20	RAL 040 50 50	RAL 070 70 80
<b>Suffix*</b>	PF/B	PF/W	PF/SG	PF/DB	PF/LB	PF/GN	PF/CR	PF/Y
<b>Coffee</b>	100	100	100	100	100	100	100	100
<b>Meeting</b>	110	110	110	110	110	110	110	110
<b>Poseur</b>	120	120	120	120	120	120	120	120



## Range Information

- Standard MFC tops available to specify - see finishes page for more information
- Painted glass tops are POA
- Standard veneer tops include Black American Walnut, Oak, Steamed Beech and Maple
- Chromed steel base frame
- Toughened sandblasted glass top as standard
- Complements the Layla collection



TOP SHAPE	Code:	Description:	Unit Size			Sand-blasted	Clear Glass	Laminate	Black Glass	Veneer	 (lb)
			W	D	H						
	LAT/1	25.5" Square Table 8.75" High Chrome Frame	25.5"	25.5"	8.75"	1886	1886	1886	2540	2654	
	LAT/2	55" x 25.5" Table 8.75" High Chrome Frame	55"	25.5"	8.75"	2806	2806	2806	3672	3774	
	LAT/3	25.5" Square Table 33.25" High Chrome Frame	25.5"	25.5"	33.25"	2132	2132	2132	2756	2702	
	LAT/4	55" x 25.5" Table 33.25" High Chrome Frame	55"	25.5"	33.25"	3110	3110	3110	3926	3500	

TABLES



## Range Information

The Line Coffee Table is designed with a light and airy form, the table top almost floating above its thin steel frame. Line has a playful yet quiet personality complementing any setting.

- Polished 0.5" (12mm) diameter steel sled base
- 31.5" (800mm) diameter circular table top
- Table top available in standard Laminate finishes



**LINE/1**  
**SKID FRAME**

**Code:**

**Description**

**\$**

  
**(lb)**

**LINE/1/BEE**

Line table with  
800mm Beech Laminate top

520

**LINE/1/W**

Line table with  
800mm white Laminate top

520



**DIMENSIONS**

Height: **400mm (15.75")**  
Width: **800mm (31.5")**  
Depth: **800mm (31.5")**

 **Product Weight**

TABLES

**Painted Frame Options**

<b>Color Choice</b>	<b>RAL 9005</b>	<b>RAL 9016</b>	<b>RAL 060 60 05</b>	<b>RAL 240 20 22</b>	<b>RAL 220 70 10</b>	<b>RAL 130 30 20</b>	<b>RAL 040 50 50</b>	<b>RAL 070 70 80</b>
<b>Suffix*</b>	<b>PF/B</b>	<b>PF/W</b>	<b>PF/SG</b>	<b>PF/DB</b>	<b>PF/LB</b>	<b>PF/GN</b>	<b>PF/CR</b>	<b>PF/Y</b>
	inc	inc	160	160	160	160	160	160



## Range Information

- Laminate or Walnut tops are available in either square or chamfered edges
- Chrome base or painted base in any of the 8 standard Boss RAL colors shown opposite
- Stool range also available



31.5" (800mm) DIAMETER TOP	Code:	Description:	Unit Size Dia x H		Square Edge Only	Chamfered Edge Only	(lb)
					Laminate 1"	Laminate 1"	
	<b>MAG/3C</b>	Coffee Table 31.5" (800mm) Dia Top Chrome Frame	800mm Dia 31.5"	345mm 16.25"	1462	1616	
	<b>MAG/3C/PF*</b>	Coffee Table 31.5" (800mm) Dia Top Painted Frame  *Suffix your PF code with the color code listed below	800mm Dia 31.5"	345mm 16.25"	2288	2442	

**DIMENSIONS**  
Height: 345mm (18.5")  
Diameter: 800mm (31.5")

47.25" (1200mm) DIAMETER TOP	Code:	Description:	Unit Size Dia x H		Square Edge Only	Chamfered Edge Only	(lb)
					Laminate 1"	Laminate 1"	
	<b>MAG/1200</b>	Coffee Table 47.25" (1200mm) Dia Top Chrome Frame	1200mm Dia 47.25"	345mm 16.25"	2630	2906	
	<b>MAG/1200/PF*</b>	Coffee Table 47.25" (1200mm) Dia Top Painted Frame  *Suffix your PF code with the color code listed below	1200mm Dia 47.25"	345mm 16.25"	4118	4394	

**DIMENSIONS**  
Height: 345mm (18.5")  
Diameter: 1200mm (47.25")

TABLES

**\*Painted Frame Options**

Colour Choice	RAL 9005	RAL 9016	RAL 060 60 05	RAL 240 20 22	RAL 220 70 10	RAL 130 30 20	RAL 040 50 50	RAL 070 70 80
Suffix*	PF/B	PF/W	PF/SG	PF/DB	PF/LB	PF/GN	PF/CR	PF/Y
\$	\$ inc	\$ inc	POA	POA	POA	POA	POA	POA



# Metro

Tables

boss





TABLES



The Metro table collection takes its inspiration from existing modular cube arrangements.







## Range Information

- White glass top as standard
- Other glass colors available by special quotation
- Timber frame available in Oak, American Black Walnut or to a painted finish (painted finish is \$236)
- A full range of line drawings and images in the Metro range can be downloaded from our website [www.bossdesign.com/us](http://www.bossdesign.com/us)



OCCASIONAL TABLE	Code:	Description	\$	 (lb)
 <p><b>DIMENSIONS</b> Height: 500mm (20") Width: 450mm (18") Depth: 450mm (18")</p>	MET/1/ABW	Metro occasional table, American Black Walnut (As Shown)	1430	
	MET/2/OAK	Metro occasional table, Oak	1310	

LAMP TABLE	Code:	Description	\$	 (lb)
 <p><b>DIMENSIONS</b> Height: 575mm (23") Width: 400mm (15.75") Depth: 400mm (15.75")</p>	MET/3/ABW	Metro lamp table, American Black Walnut (As Shown)	1424	
	MET/4/OAK	Metro lamp table, Oak	1358	

COFFEE TABLE	Code:	Description	\$	 (lb)
 <p><b>DIMENSIONS</b> Height: 31" (13") Width: 800mm (31") Depth: 800mm (31")</p>	MET/5/ABW	Metro coffee table, American Black Walnut (As Shown)	2164	
	MET/6/OAK	Metro coffee table, Oak	2092	

TABLES

**LARGE RECTANGULAR COFFEE TABLE**

Code:

Description

\$



**MET/7/ABW**

Metro large rectangular coffee table, American Black Walnut (As Shown)

2468

**MET/8/OAK**

Metro large rectangular coffee table, Oak

2396

**DIMENSIONS**

Height: 31" (13")  
 Width: 1000mm (39")  
 Depth: 800mm (31")

**RECTANGULAR COFFEE TABLE**

Code:

Description

\$



**MET/9/ABW**

Metro rectangular coffee table, American Black Walnut (As Shown)

2020

**MET/10/OAK**

Metro rectangular coffee table, Oak

1966

**DIMENSIONS**

Height: 31" (13")  
 Width: 800mm (31")  
 Depth: 600mm (24")

**HIGH COFFEE TABLE**

Code:

Description

\$



**MET/11/ABW**

Metro High Coffee Table, American Black Walnut (As Shown)

2202

**MET/12/OAK**

Metro High Coffee Table, Oak

2088

**DIMENSIONS**

Height: 500mm (20")  
 Width: 800mm (31")  
 Depth: 800mm (31")

**HIGH LARGE RECTANGULAR COFFEE TABLE**



**DIMENSIONS**

Height: **500mm (20")**  
 Width: **1000mm (39")**  
 Depth: **800mm (31")**

Code:	Description	\$	(lb)
<b>MET/13/ABW</b>	Metro High Large Rectangular Coffee Table, American Black Walnut (As Shown)	2506	
<b>MET/14/OAK</b>	Metro High Large Rectangular Coffee Table, Oak	2398	

**HIGH RECTANGULAR COFFEE TABLE**



**DIMENSIONS**

Height: **500mm (20")**  
 Width: **800mm (31")**  
 Depth: **600mm (24")**

Code:	Description	\$	(lb)
<b>MET/15/ABW</b>	Metro High Rectangular Coffee Table, American Black Walnut (As Shown)	2000	
<b>MET/16/OAK</b>	Metro High Rectangular Coffee Table, Oak	1866	

**Product Weight**

TABLES

**Niko**

Table

boss



Clean and slim-line design, Niko is a versatile and sophisticated executive or meeting table choice. It comes in a range of dimensions and forms & is ideally suited to meeting, conference and boardroom spaces.

Niko is available with a square, rectangular, oval, elliptical or circular table top profile, with either a square or reverse-chamfered edge detail.



NIKO TABLES

## Tables

### Table Tops

Available in six table top shapes: Square, Rectangular, Circular, Elliptical, Vase and Barrel

Four standard finishes: Laminate Laminate, Veneer & Fenix.

See appendix for Boss Design's standard color ways

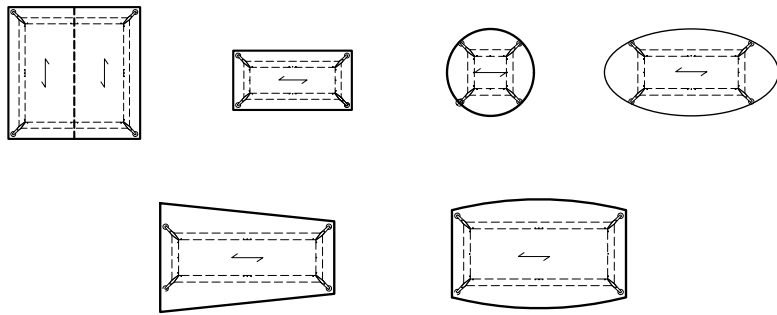

### Table Leg & Frame

The Niko table is available in an Oak leg with an Black aluminum rail system as standard

Other rail color finishes are available subject to a minimum order quantity. Please contact your sales representative for more information on pricing and availability.



Oak Wooden



Oak Wooden

### Power & Data Management Options

Various power and data options are available to specify on Niko so please **see page 524** for the full range available.

As standard, power is located center of the table and runs parallel with the longest edges.

Drawings are provided for your reference prior to ordering and are to be used as a guide.

For customers own power please contact us for compatibility.



### Cable Management, Power Cut Outs & Flaps

Niko does **NOT** feature cable managed legs

If you are supplying your own power and data, please supply us with the relevant product information so we can advise on comparability.

Customers own power & data will incur a cut out charge. Please see options for pricing.



## Detailed Specification

### Legs & Frame

The Niko table is available with an Oak leg as standard accompanied with a black painted rail detail

### Standard wooden leg finishes:

- Oak Wood

### Optional (chargeable - POA) painted leg finishes:

- Stained Oak legs - Black. Other colors POA
- Painted metal rail system (black as standard) - POA

### Table Top Detail

Square Edge:

1" across the whole range

Square Edge or Chamfered:

Laminate

Veneer

Fenix

4" (100mm) radius corners

### Grain Direction ↔

Single table top pieces - Grain runs lengthways as standard

Two or more table top pieces - Grain runs widthways as standard.

### Table Power Options

Please see **page 524** for the full list of compatible power options. If a power option is not listed, or you wish to use an alternative, then please contact your sales representative.

**A 78.75" is supplied as standard however other lengths are available - see page 524 for more information.**

### Power Location

As a default, Niko power locations are central to the table and parallel to the longest edge. If you would like an alternative direction/location please contact your sales representative for more information.

### Seating Guidelines

Seating guidelines are based on a seat width of 23.5" from the edge of the table and are to be used as a guideline only.

For an accurate information specific to a chair in our range, please contact us or download the specific CAD files from our website [bossdesign.com](http://bossdesign.com).

### Niko Digital Assets

We hold a library of assets for our Deploy product range which you can find by scanning the QR code below. If you are viewing our interactive PDF, simply click on the QR code to be taken directly there.



### Edge Details

#### Square Edge

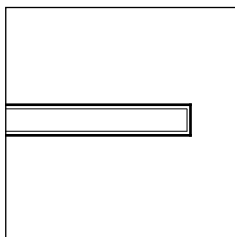

Side Profile

#### Chamfered Edge

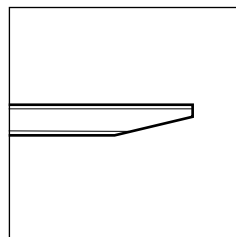

Side Profile

#### 4" Radius Corners

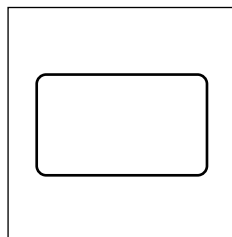

Plan View

#### Standard Finish Colors

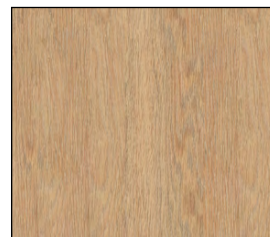

Oak

\*Due to the printing process, colors are approximate.  
Please view an RAL color chart for accurate color representation



## Top Shapes

A complete and detailed list of sizes and specifications can be viewed by scanning the QR code below.

If you are viewing this digitally, simply click the QR code below.



## Boss Design Suggested Power & Data Options

Various power and data options are available to specify on Niko however we recommend the following shown (right) as standard options.

Additionally, power is located center of the table and runs parallel with the longest edges.

For customers own power please contact us for compatibility



ARC-H LD  
Black or White



Pixel  
1x Power +TUF



Phase  
1x Power, 1x TUF

TOP SHAPE	Code:	Size L x W x H			Seats Approx.	No. of Tops	Square OR Chamfered Edge			 (lb)
							Laminate	Veneer	Fenix	
							1"	1"	1"	
4 Leg Square	<b>NIK/S/10</b>	39.25"	39.25"	29.25"	4	1	3622	4010	3946	
4 Leg Square	<b>NIK/S/12</b>	47.25"	47.25"	29.25"	4	1	3942	4242	4750	
4 Leg Square	<b>NIK/S/15</b>	59"	59"	29.25"	8	1	4462	4826	5256	
4 Leg Square	<b>NIK/S/20</b>	78.75"	78.75"	29.25"	8	2	6936	6382	8806	
4 Leg Rectangle	<b>NIK/R/127</b>	47.25"	27.5"	29.25"	6	1	3782	4120	3984	
4 Leg Rectangle	<b>NIK/R/147</b>	55"	27.5"	29.25"	6	1	3874	4216	4146	
4 Leg Rectangle	<b>NIK/R/1575</b>	59"	29.5"	29.25"	6	1	4094	4450	4364	
4 Leg Rectangle	<b>NIK/R/168</b>	63"	31.5"	29.25"	6	1	4256	4450	5066	
4 Leg Rectangle	<b>NIK/R/189</b>	71"	35.5"	29.25"	6	1	4150	4454	4960	
4 Leg Rectangle	<b>NIK/R/2010</b>	78.75"	39.25"	29.25"	6	1	4146	4508	5032	
4 Leg Rectangle	<b>NIK/R/2412</b>	94.5"	47.25"	29.25"	8	1	4488	4850	5492	
4 Leg Circular	<b>NIK/C/12</b>	47.25" dia		29.25"	4	1	3672	3732	4522	
4 Leg Circular	<b>NIK/C/15</b>	59" dia		29.25"	4	1	4162	4378	5054	
4 Leg Elliptical	<b>NIK/E/189</b>	71"	35.5"	29.25"	6	1	4036	4748	5242	
4 Leg Elliptical	<b>NIK/E/2010</b>	78.75"	39.25"	29.25"	6	1	4306	5040	5648	
4 Leg Vase	<b>NIK/V/241510</b>	94.5" x 59" x 39.25"		29.25"	8	1	4406	5238	5872	
<b>Dimensions show length, thickest width &amp; narrowest width</b>		<b>L x TW x NW</b>								
4 Leg Barrel	<b>NIK/B/241512</b>	94.5" x 59" x 47.25"		29.25"	8	1	4406	5238	5872	

NIKO TABLES

 Product Weight

### Options

CODE:	DESCRIPTION	\$
<b>ARC-H LD</b>	Wireless charging - Gray or White	260
<b>PIXEL</b>	1x Power & 1x TUF - White	385
<b>PHASE</b>	1x Power & 1x TUF - White or Black	400
<b>CUT OUT</b>	Customers Own Power & Data	106
<b>RAD 1</b>	4" (100mm) Radius Corners - table with 1 top	306
<b>STAINED LEGS</b>	Black Stained Legs - no upcharge. Other Color Stains are POA	inc

# Pause, Wait & Us

boss



Tables







## Range Information

- Available in Oak, American Black Walnut or to a painted finish (painted finish is \$236)
- Veneered table top
- Finish: Clear lacquer
- A full range of line drawings and images in the Pause, Wait & Us range can be downloaded from our website [www.bosssdesign.com/us/pausewaitus](http://www.bosssdesign.com/us/pausewaitus)



<b>PAUSE TABLE</b>	<b>Code:</b>	<b>Description</b>	<b>\$</b>	 <b>(lb)</b>
 <p><b>DIMENSIONS</b> Height: <b>500mm (20")</b> Width: <b>450mm (18")</b> Depth: <b>450mm (18")</b></p>	<b>PAU/1/ OAK</b>	Pause side table, Oak (As Shown)	1358	
	<b>PAU/1/ABW</b>	Pause side table, American Black Walnut	1522	

<b>WAIT TABLE</b>	<b>Code:</b>	<b>Description</b>	<b>\$</b>	 <b>(lb)</b>
 <p><b>DIMENSIONS</b> Height: <b>350mm (14")</b> Width: <b>600mm (24")</b> Depth: <b>600mm (24")</b></p>	<b>WAI/1/OAK</b>	Wait coffee table, Oak (As Shown)	1248	
	<b>WAI/1/ABW</b>	Wait coffee table, American Black Walnut	1330	

<b>US TABLE</b>	<b>Code:</b>	<b>Description</b>	<b>\$</b>	 <b>(lb)</b>
 <p><b>DIMENSIONS</b> Height: <b>350mm (14")</b> Width: <b>600mm (24")</b> Depth: <b>600mm (24")</b></p>	<b>US/25/OAK</b>	Circular coffee table, Oak (As Shown)	1248	
	<b>US/25/ABW</b>	Circular coffee table, ABW	1330	

TABLES

 **Product Weight**

# Pegasus

Tables

boss



Image Shows Rectangular Pegasus table with black legs, accompanied by Trinetic task chairs

Clean and slim-line design, Pegasus is a versatile and sophisticated executive table choice. It comes in a range of dimensions and forms & is ideally suited to meeting, conference and boardroom spaces.

Pegasus comes as a square, rectangular, oval, elliptical or circular table, alternative table top finishes, with either a square or reverse-chamfered edge detail.



PEGASUS TABLES

## Tables

### Table Tops

Available in six table top shapes: Square, Rectangle, Circular, Elliptical, Vase & Barrel

Five standard finishes: Laminate, Veneer & Fenix.

See appendix for Boss Design's standard color ways

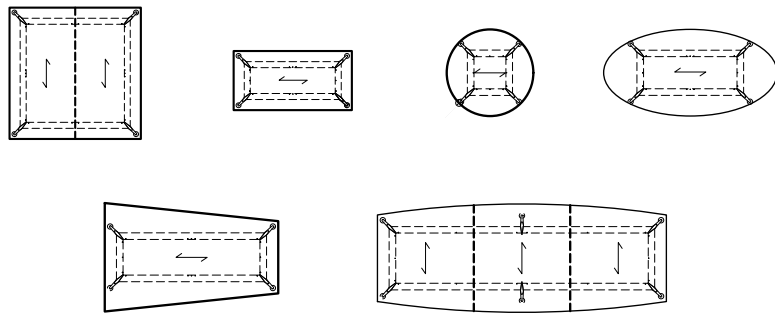

### Table Frame & Leg Finishes

Black RAL 9005, Silver 9006 or White RAL 9016 painted leg or polished Aluminum Legs only.

Pegasus foot is adjustable to suit uneven floors and is available in black or grey as shown opposite



Black  
RAL 9005

White  
RAL 9016

Silver  
RAL 9006

Polished  
Aluminum

### Power & Data Management Options

Various power and data options are available to specify on Deploy so please see page 524 for the full range available

As standard, power is located center of the table and runs parallel with the longest edges.

Drawings are provided for your reference prior to ordering and are to be used as a guide

For customers own power please contact us for compatibility



### Cable Management, Power Cut Outs & Flaps

Pegasus features cable managed legs and under frame as standard

If you are supplying your own power and data, please supply us with the relevant product information so we can advise on comparability.

Customers own power & data will incur a cut out charge. Please see options for pricing.



## Detailed Specification

### Legs & Frame

The Pegasus leg & frame consists of a cast aluminum component available in a polished aluminum or optional painted finish, that features cable management within the leg.

#### Standard metal leg finishes:

- Polished Aluminum

#### Optional (chargeable) painted leg finishes:

- White - RAL 9016
- Black - RAL 9005
- Silver - RAL 9006

Other colors are available - POA and are subject to minimum order quantities

#### Non - Standard metal leg finishes:

- Any RAL colors outside of the Boss standard colors shown below are available as POA and are subject to minimum order quantities

### Foot Finish

As shown, Pegasus comes with the choice of two colored feet. Black adjustable feet are fitted on the Black, Polished Aluminum & Polished legs. The Grey foot is fitted as standard on the White & Silver legs.

### Table Top Detail

Square Edge:

1" across the whole range

Square Edge or Chamfered:

Laminate

Veneer

Fenix

### Grain Direction ↔

Single table top pieces - Grain runs lengthways as standard

Two or more table top pieces - Grain runs widthways as standard

### Table Power Options

Please see page 524 for the full list of compatible power options. If a power option is not listed, or you wish to use an alternative, then please contact your sales representative.

**A 78.75" is supplied as standard however other lengths are available - see page 532 for more information.**

### Power Location

As a default, Pegasus power locations are central to the table and parallel to the longest edge. If you would like an alternative direction/location please contact your sales representative for more information.

### Seating Guidelines

Seating guidelines are based on a seat width of 600mm from the edge of the table and are to be used as a guideline only.

For an accurate information specific to a chair in our range, please contact us or download the specific CAD files from our website [bossdesign.com/us/pegasus](http://bossdesign.com/us/pegasus).

### Pegasus Digital Assets

We hold a library of assets for our Deploy product range which you can find by scanning the QR code below. If you are viewing our interactive PDF, simply click on the QR code to be taken directly there.



#### Edge Details Square Edge

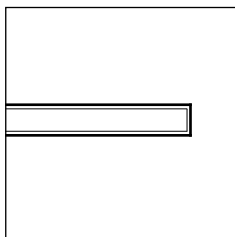

Side Profile

#### Chamfered Edge

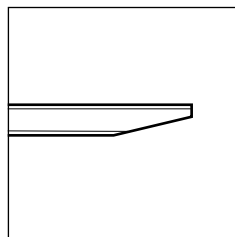

Side Profile

#### 100mm Radius Corners

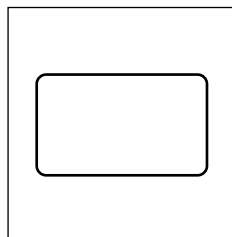

Plan View

#### RAL Colors\* Standard Painted Leg Colors



Black RAL 9005

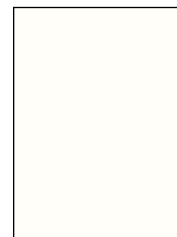

White RAL 9016

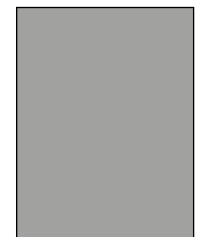

Silver RAL 9006

\*Due to the printing process, colors are approximate.

Please view an RAL color chart for accurate color representation

### Certification

Pegasus is certified to the following standard(s):

- **BS EN 15372 : 2008** - Furniture. Strength, durability and safety.



Image Shows Pegasus Rectangular table with polished legs, accompanied by Delphi cantilever chairs

## Square & Rectangular Tops

A complete and detailed list of sizes and specifications can be viewed by scanning the QR code below.

If you are viewing this digitally, simply click the QR code below.



## Boss Design Suggested Power & Data Options

Various power and data options are available to specify on Pegasus however we recommend the following shown (right) as standard options.

Additionally, power is located centre of the table and runs parallel with the longest edges.

For customers own power please contact us for compatibility



ARC-H LD  
Black or White



Pixel  
1x Power +TUF



Phase  
1x Power, 1x TUF

TOP SHAPE	Code:	Size			Seats Approx.	No. of Tops	Square OR Chamfered Edge			 (lb)
		L	W	H			Laminate 1"	Veneer 1"	Fenix 1"	
4 Leg Square	PEG/S/10	39.25	39.25	29.25	4	1	3174	3584	3514	-
4 Leg Square	PEG/S/12	47.25	47.25	29.25	4	1	3508	3824	4358	-
4 Leg Square	PEG/S/15	59	59	29.25	8	1	4056	4436	4886	-
4 Leg Square	PEG/S/20	78.75	78.75	29.25	8	2	6650	6066	8604	-
4 Leg Rectangle	PEG/R/127	47.25	27.5	29.25	6	1	3340	3694	3814	-
4 Leg Rectangle	PEG/R/147	55"	27.5	29.25	6	1	3484	3852	3976	-
4 Leg Rectangle	PEG/R/1575	59	29.5	29.25	6	1	3628	4008	4142	-
4 Leg Rectangle	PEG/R/168	63	31.5	29.25	6	1	3694	4082	4214	-
4 Leg Rectangle	PEG/R/189	71	35.5	29.25	6	1	3964	4384	4526	-
4 Leg Rectangle	PEG/R/2010	78.75	39.25	29.25	6	1	4186	4626	4776	-
4 Leg Rectangle	PEG/R/2412	94.5	47.25	29.25	8	1	4696	5190	5360	-
6 Leg Rectangle	PEG/R/3012	118	47.25	29.25	10	2	8798	9624	10960	-
6 Leg Rectangle	PEG/R/3015	118	59	29.25	12	2	9694	10390	11402	-
6 Leg Rectangle	PEG/R/3512	137.75	47.25	29.25	10	3	10408	10892	12154	-
6 Leg Rectangle	PEG/R/3515	137.75	59	29.25	12	3	10878	11652	12664	-
6 Leg Rectangle	PEG/R/4012	157.5	47.25	29.25	10	3	10352	11342	13368	-
6 Leg Rectangle	PEG/R/4015	157.5	59	29.25	12	3	11178	11972	12896	-
8 Leg Rectangle	PEG/R/4512	177	47.25	29.25	14	3	11568	12556	13954	-
8 Leg Rectangle	PEG/R/4515	177	59	29.25	16	3	12696	13318	14644	-
8 Leg Rectangle	PEG/R/5012	197	47.25	29.25	14	4	14524	14440	17026	-
8 Leg Rectangle	PEG/R/5015	197	59	29.25	16	4	15118	15258	17628	-
8 Leg Rectangle	PEG/R/5512	216.5	47.25	29.25	20	4	16260	16528	18760	-
8 Leg Rectangle	PEG/R/5515	216.5	59	29.25	20	4	16872	17354	19372	-
10 Leg Rectangle	PEG/R/6012	236.25	47.25	29.25	20	4	16022	16366	18528	-
10 Leg Rectangle	PEG/R/6015	236.25	59	29.25	22	4	16636	17178	19150	-

PEGASUS TABLES

 Product Weight

### Options

CODE:	DESCRIPTION	\$
<b>ARC-H LD</b>	Wireless charging - Gray or White	260
<b>PIXEL</b>	1x Power & 1x TUF - White	385
<b>PHASE</b>	1x Power & 1x TUF - White or Black	400
<b>PF/</b>	Painted Finishes - Black Ral 9005, Silver 9006 or White RAL 9016 - Price Per Leg	160 per leg
<b>CUT OUT</b>	For power and data	106
<b>RAD 1</b>	4" (100mm) Radius Corners - table with 1 top	306
<b>RAD 2</b>	4" (100mm) Radius Corners - table with 2 or more tops	612

<b>Product Certification</b>	BS EN 15372: 2008 - Furniture, strength, durability & safety
------------------------------	--



Image Shows Pegasus Elliptical table with polished legs, accompanied by Pro cantilever chairs

## Barrel, Vase, Circular & Elliptical Tops

A complete and detailed list of sizes and specifications can be viewed by scanning the QR code below.

If you are viewing this digitally, simply click the QR code below.



## Boss Design Suggested Power & Data Options

Various power and data options are available to specify on Pegasus however we recommend the following shown (right) as standard options.

Additionally, power is located centre of the table and runs parallel with the longest edges.

For customers own power please contact us for compatibility



ARC-H LD  
Black or White



Pixel  
1x Power +TUF



Phase  
1x Power, 1x TUF

TOP SHAPE	Code:	Size L x W x H		Seats Approx.	No. of Tops	Square OR Chamfered Edge			 (lb)	
						Laminate 1"	Veneer 1"	Fenix 1"		
3 Leg Circular	<b>PEG/C/9</b>	35.5 dia	29.25	4	1	2232	2260	3026		
4 Leg Circular	<b>PEG/C/12</b>	47.25 dia	29.25	4	1	3230	3290	4116		
4 Leg Circular	<b>PEG/C/15</b>	59 dia	29.25	4	1	3740	3968	4678		
4 Leg Elliptical	<b>PEG/E/189</b>	71	35.5	29.25	6	1	3610	4354	4872	
4 Leg Elliptical	<b>PEG/E/2010</b>	78.75	39.25	29.25	6	1	3894	4660	5296	
6 Leg Elliptical	<b>PEG/E/2412</b>	94.5	47.25	29.25	8	1	3774	4650	5310	
<b>Dimensions show length, thickest width &amp; narrowest width</b>		<b>L x TW x NW</b>								
4 Leg Barrel	<b>PEG/B/241512</b>	94.5 x 59 x 47.25	29.25	8	1	3996	4868	5532		
6 Leg Barrel	<b>PEG/B/301512</b>	118 x 59 x 47.25	29.25	12	2	10598	11280	12296		
6 Leg Barrel	<b>PEG/B/351512</b>	137.75 x 59 x 47.25	29.25	12	3	12222	12998	14014		
6 Leg Barrel	<b>PEG/B/401512</b>	157.5 x 59 x 47.25	29.25	14	3	12516	13318	14232		
8 Leg Barrel	<b>PEG/B/451512</b>	177.25 x 59 x 47.25	29.25	14	3	14042	14664	15990		
8 Leg Barrel	<b>PEG/B/501512</b>	196.75 x 59 x 47.25	29.25	18	4	16464	16602	18964		
8 Leg Barrel	<b>PEG/B/551512</b>	216.5 x 59 x 47.25	29.25	20	4	18208	18690	20714		
10 Leg Barrel	<b>PEG/B/601512</b>	236.25 x 59 x 47.25	29.25	20	4	17986	18524	20486		
4 Leg Vase	<b>PEG/V/241510</b>	94.5 x 59 x 39.25	29.25	8	1	3996	4868	5532		
6 Leg Vase	<b>PEG/V/301510</b>	118 x 59 x 39.25	29.25	12	2	10598	11280	12296		
6 Leg Vase	<b>PEG/V/351510</b>	137.75 x 59 x 39.25	29.25	12	3	12222	12998	14014		
6 Leg Vase	<b>PEG/V/401510</b>	157.5 x 59 x 39.25	29.25	14	3	12516	13318	14232		

PEGASUS TABLES

 Product Weight

### Options

CODE:	DESCRIPTION	\$
<b>ARC-H LD</b>	Wireless charging - Gray or White	260
<b>PIXEL</b>	1x Power & 1x TUF - White	210
<b>PHASE</b>	1x Power & 1x TUF - White or Black	400
<b>PF/</b>	Painted Finishes - Black Ral 9005, Silver 9006 or White RAL 9016 - Price Per Leg	160 per leg
<b>CUT OUT</b>	For power and data	106
<b>RAD 1</b>	4" (100mm) Radius Corners - table with 1 top	306
<b>RAD 2</b>	4" (100mm) Radius Corners - table with 2 or more tops	612

**Product Certification**

BS EN 15372: 2008 - Furniture, strength, durability & safety

# Reef

Tables

boss



Reef is a collection of tables offering a broad selection of uses across the workplace.

The table base is available with the choice of a 23.5" (600mm) diameter circular base or 19.75" x 19.75" (500mm x 500mm) square base.

Reef is a robust collection with the table base firmly secured to the stem.

Reef offers the specifier a selection of table top options and is designed as a coffee, poseur, meeting or dining height table.



## Tables

### Table Tops

Available in three table top shapes: Circular, Square and Rectangular

Two standard finishes: Laminate & Veneer.

Square or Chamfered edge finish options

See appendix for Boss Design's standard color-ways

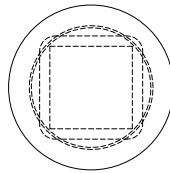

Single Base with Circular Top

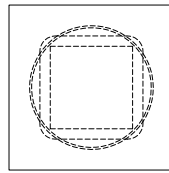

Single Base with Square Top

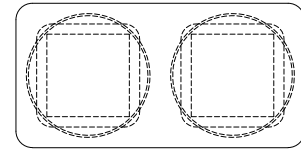

Dual Base Configuration

### Table Frame & Leg Finishes

Reef is available in 9 different colors, plus a chrome base.

#### Standard:

Black - RAL 9005

White - RAL 9016

Silver RAL 9006

#### Optional:

Grey - RAL 060 60 05

Dark Blue - RAL 240 20 22

Light Blue - RAL 220 70 10

Green - RAL 130 30 20

Coral - RAL 040 50 50

Yellow - RAL 070 70 80



### Power & Data Management Options

Reef is able to be specified with a variety of power and data options, however we recommend both Pixel and ARC-H LD units as standard for a central position.

For a full list of power and data **see page 524** for the full range available

For customers own power please contact us for compatibility

Please note: Power is **NOT** available with polished bases



ARC-H LD  
Black or White



Pixel  
1x Power +TUF

### Cable Management

When selecting power and data with a Reef table, a larger steel stem and heightened base is used which allows for the Pixel unit's power cables to be located internally within the stem (shown right, in green).

The power and data cables neatly exit the underside of the raised base ready to be fitted into trunking or other power sockets.



With internal cable management located within the stem (when specifying Pixel or ARC-H LD power units), Reef can be placed directly over any floor power boxes which can help maintain a cable free aesthetic whilst simultaneously hiding most floor power boxes

## Detailed Specification

### Base and Stem

Reef consists of a steel base and stem, available in the following shapes:

- Circular
- Square

Reef is also available in three heights:

- Coffee - H 16.75" (425mm)
- Dining - H 28.25" (720mm)
- Poseur - H 43.25" (1100mm)

### Standard frame finishes:

- Black RAL 9005
- Silver RAL 9006

### Optional Colors - Additional Up-charge

- Grey - RAL 060 60 05
- Dark Blue - RAL 240 20 22
- Light Blue - RAL 220 70 10
- Green - RAL 130 30 20
- Coral - RAL 040 50 50
- Yellow - RAL 070 70 80

Polished Chrome base

### Table Top Detail

1" Across the whole range available in either circular or square top profiles. Square top profiles are also available with radius corners.

Square or Chamfered Options:

- Veneer
- Laminate

### Grain Direction ←

Grain runs lengthways

### Table Power Options

As standard, we recommend the use of a Pixel or ARC-H LD unit that is located centrally

When specifying a power and data unit, a marginally wider stem is used in order to accommodate the power unit. This stem also allows for the cabling to be neatly hidden away inside, exiting at the bottom of the base. This allows you to place the table directly over any floor box or trunking for neat and efficient cable management.

Please note that the cost of the pixel displayed on the following pages includes the enhanced base and stem, power unit and top cut out.

Other power options are available however these are priced on a POA basis and require prior approval from our technicians.

A 78.75" (2m) starter cable is supplied as standard however other lengths are available - see page 532 for more information.

### Seating Guidelines

Seating guidelines are based on a seat width of 600mm from the edge of the table and are to be used as a guideline only.

For an accurate information specific to a chair in our range, please contact us or download the specific CAD files from our website

### Reef Digital Assets

We hold a library of assets for our Deploy product range which you can find by scanning the QR code below. If you are viewing our interactive PDF, simply click on the QR code to be taken directly there.



### Edge Details

Square Edge

### Chamfered Edge

### 80 mm Radius Corners

### RAL Colors\*

Standard Finish Colors

Other colors available for an upcharge

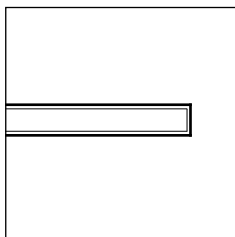

Side Profile

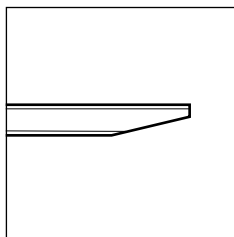

Side Profile

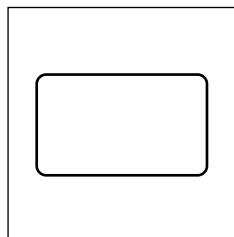

Plan View



Black RAL 9005

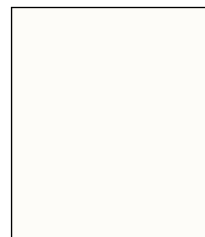

White RAL 9016

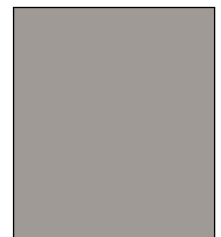

Silver RAL 9006

\*Due to the printing process, colors are approximate.  
Please view an RAL color chart for accurate color representation



## Height Options

A complete and detailed list of sizes and specifications can be viewed by scanning the QR code below.

If you are viewing this digitally, simply click the QR code below to view our 2D Line Drawings.

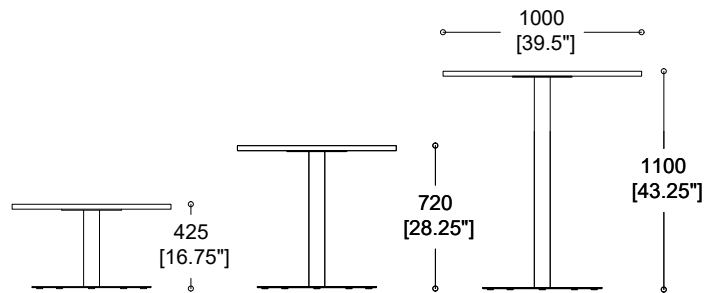

## Bases

Reef tables 47.25" x 23.5" (1200 X 600mm) and above are supplied in a double base configuration as shown opposite.

A complete and detailed list of sizes and specifications can be viewed by scanning the QR code below.

If you are viewing this digitally, simply click the QR code below.

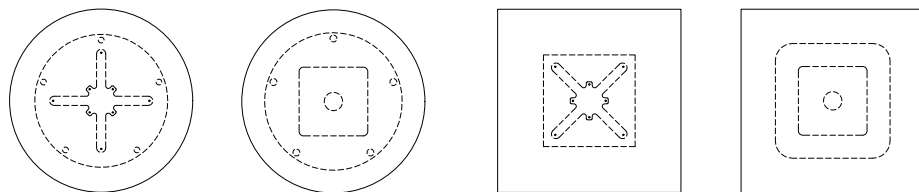

Circular Bases

Square Bases

Square OR  
Chamfered Edge

COFFEE HEIGHT	Code:	Size		Base Size	Square OR Chamfered Edge		(lb)
		L x W x H			Laminate	Veneer	
					1"	1"	
Circular	<b>RFC/C6S</b>	23.5 dia	16.75	19.75 x 19.75	1050	1088	
Circular	<b>RFC/C6C</b>	23.5 dia	16.75	23.5 dia	1046	1086	
Circular	<b>RFC/C8C</b>	31.5 dia	16.75	23.5 dia	1088	1126	
Circular	<b>RFC/C8S</b>	31.5 dia	16.75	19.75 x 19.75	1080	1118	
Circular	<b>RFC/C10C</b>	39.25 dia	16.75	23.5 dia	1410	1524	
Circular	<b>RFC/C10S</b>	39.25 dia	16.75	19.75 x 19.75	1404	1518	
Square	<b>RFC/S6C</b>	23.5	23.5	16.75	23.5 dia	992	1030
Square	<b>RFC/S6S</b>	23.5	23.5	16.75	19.75 x 19.75	984	1022
Square	<b>RFC/S8C</b>	31.5	31.5	16.75	23.5 dia	1012	1050
Square	<b>RFC/S8S</b>	31.5	31.5	16.75	19.75 x 19.75	1004	1042
Rectangle	<b>RFC/R126S*</b>	47.25	23.5	16.75	19.75 x 19.75*	1524	1828
Rectangle	<b>RFC/R128S*</b>	47.25	31.5	16.75	19.75 x 19.75*	1562	1858
Rectangle	<b>RFC/R147S*</b>	55	27.5	16.75	19.75 x 19.75*	1582	1866
Rectangle	<b>RFC/R147C*</b>	55	27.5	16.75	23.5 dia*	1590	1876
Rectangle	<b>RFC/R168S*</b>	63	31.5	16.75	19.75 x 19.75*	1706	1878
Rectangle	<b>RFC/R168C*</b>	63	31.5	16.75	23.5 dia*	1714	1884
Rectangle	<b>RFC/R189S*</b>	71	35.5	16.75	19.75 x 19.75*	1726	1982
Rectangle	<b>RFC/R189C*</b>	71	35.5	16.75	23.5 dia*	1732	1990
Rectangle	<b>RFC/R2010S*</b>	78.75	39.25	16.75	19.75 x 19.75*	1744	2002
Rectangle	<b>RFC/R2010C*</b>	78.75	39.25	16.75	23.5 dia*	1752	2008

REEF TABLE

\*Table sizes 47.25" x 23.5" (1200 x 600) and above feature dual bases

Leather Square Footage Product Weight



### Coffee Table - Painted Frame Options

Colour Choice	RAL 9005	RAL 9016	RAL 9006	RAL 060 60 05	RAL 240 20 22	RAL 220 70 10	RAL 130 30 20	RAL 040 50 50	RAL 070 70 80
Suffix*	PF/B	PF/W	PF/SIL	PF/SG	PF/DB	PF/LB	PF/GN	PF/CR	PF/Y
\$	\$ inc	\$ inc	\$ inc	240	240	240	240	240	240

\*If table features two stems and bases, apply two painted upcharges.

### Options

CODE:	DESCRIPTION	\$
<b>POWER &amp; DATA</b> (SEE PAGES 528 FOR MORE OPTIONS - ADD \$124 TO COST OF POWER TO COVER UPGRADED COLUMN AND FOOT PLATE)	<b>Pixel unit - 1x US Power with TUF A+C</b> N.B. Price includes Base and Stem upgrade with internal cable management, tabletop cut out and 1x Pixel unit inc. 78.75"	385 + 124
	<b>ARC-H LD White/Gray</b> N.B. Price includes Base and Stem upgrade with internal cable management, tabletop cut out and 1x Pixel unit inc. 78.75"	260 + 124

CODE:	DESCRIPTION	\$
<b>RADIUS CORNERS</b>	3.25" Radius Corners	106
<b>CUSTOMERS OWN POWER</b>	Table Top cut out for customers own power	106

DINING HEIGHT	Code:	Size		Base Size	Square OR Chamfered Edge		(lb)
		L	W x H		Laminate 1"	Veneer 1"	
Circular	<b>RFM/C6C</b>	23.5 dia	28.25	23.5 dia		1076	1106
Circular	<b>RFM/C6S</b>	23.5 dia	28.25	19.75 x 19.75		1068	1098
Circular	<b>RFM/C8C</b>	31.5 dia	28.25	23.5 dia		1098	1142
Circular	<b>RFM/C8S</b>	31.5 dia	28.25	19.75 x 19.75		1092	1132
Circular	<b>RFM/C10C</b>	39.25 dia	28.25	23.5 dia		1430	1528
Circular	<b>RFM/C10S</b>	39.25 dia	28.25	19.75 x 19.75		1424	1522
Circular	<b>RFM/C12C*</b>	47.25 dia	28.25	23.5 dia*		1460	1554
Elliptical	<b>RFM/E128C</b>	47.25	31.5	28.25	23.5 dia*	1414	1516
Square	<b>RFM/S6C</b>	23.5	23.5	28.25	23.5 dia	1004	1060
Square	<b>RFM/S6S</b>	23.5	23.5	28.25	19.75 x 19.75	996	1054
Square	<b>RFM/S8C</b>	31.5	31.5	28.25	23.5 dia	1016	1068
Square	<b>RFM/S8S</b>	31.5	31.5	28.25	19.75 x 19.75	1006	1060
Rectangle	<b>RFM/R126S*</b>	47.25	23.5	28.25	19.75 x 19.75*	1540	1844
Rectangle	<b>RFM/R128C*</b>	47.25	31.5	28.25	23.5 dia*	1590	1884
Rectangle	<b>RFM/R128S*</b>	47.25	31.5	28.25	19.75 x 19.75*	1582	1878
Rectangle	<b>RFM/R147S*</b>	55	27.5	28.25	19.75 x 19.75*	1600	1888
Rectangle	<b>RFM/R147C*</b>	55	27.5	28.25	23.5 dia*	1610	1894
Rectangle	<b>RFM/R168S*</b>	63	31.5	28.25	19.75 x 19.75*	1726	1878
Rectangle	<b>RFM/R168C*</b>	63	31.5	28.25	23.5 dia*	1732	1906
Rectangle	<b>RFM/R189S*</b>	70.75	35.5	28.25	19.75 x 19.75*	1744	2002
Rectangle	<b>RFM/R189C*</b>	70.75	35.5	28.25	23.5 dia*	1752	2008
Rectangle	<b>RFM/R2010S*</b>	78.75	39.25	28.25	19.75 x 19.75*	1764	2020
Rectangle	<b>RFM/R2010C*</b>	78.75	39.25	28.25	23.5 dia*	1772	2028

\*Table sizes 47.25" x 23.5" (1200 x 600mm) and above feature dual bases Leather Square Footage Product Weight

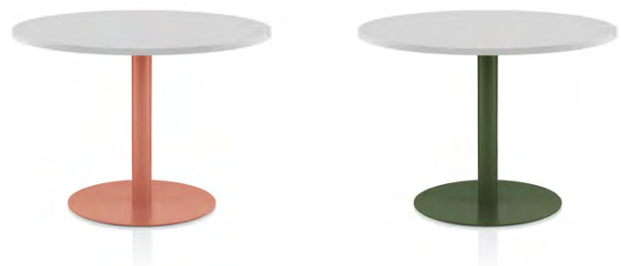

### Dining Table - Painted Frame Options

Colour Choice	RAL 9005	RAL 9016	RAL 9006	RAL 060 60 05	RAL 240 20 22	RAL 220 70 10	RAL 130 30 20	RAL 040 50 50	RAL 070 70 80
Suffix*	PF/B	PF/W	PF/SIL	PF/SG	PF/DB	PF/LB	PF/GN	PF/CR	PF/Y
\$	\$ inc	\$ inc	\$ inc	250	250	250	250	250	250

\*if table features two stems and bases, apply two painted upcharges.

### Options

CODE:	DESCRIPTION	\$
<b>POWER &amp; DATA</b> (SEE PAGES 528 FOR MORE OPTIONS - ADD \$124 TO COST OF POWER TO COVER UPGRADED COLUMN AND FOOT PLATE)	<b>Pixel unit - 1 x US Power with TUF A+C</b> N.B. Price includes Base and Stem upgrade with internal cable management, tabletop cut out and 1x Pixel unit inc. 78.75"	385 + 124
	<b>ARC-H LD White/Gray</b> N.B. Price includes Base and Stem upgrade with internal cable management, tabletop cut out and 1x Pixel unit inc. 78.75"	260 + 124

CODE:	DESCRIPTION	\$
<b>RADIUS CORNERS</b>	3.25" Radius Corners	106
<b>CUSTOMERS OWN POWER</b>	Table Top cut out for customers own power	106

POSEUR HEIGHT	Code:	Size L x W x H		Base Size	Square OR Chamfered Edge		(lb)
					Laminate 1"	Veneer 1"	
Circular	<b>RFP/C6C</b>	23.5 dia	43.25	23.5 dia		1132	1182
Circular	<b>RFP/C6S</b>	23.5 dia	43.25	19.75 x 19.75		1126	1174
Circular	<b>RFP/C8C</b>	31.5 dia	43.25	23.5 dia		1154	1202
Circular	<b>RFP/C8S</b>	31.5 dia	43.25	19.75 x 19.75		1162	1194
Square	<b>RFP/S6C</b>	23.5	23.5	43.25	23.5 dia	1022	1080
Square	<b>RFP/S6S</b>	23.5	23.5	43.25	19.75 x 19.75	1016	1072
Square	<b>RFP/S8C</b>	31.5	31.5	43.25	23.5 dia	1042	1098
Square	<b>RFP/S8S</b>	31.5	31.5	43.25	19.75 x 19.75	1034	1092
Rectangle	<b>RFP/R126S*</b>	47.25	600	43.25	19.75 x 19.75*	1578	1878
Rectangle	<b>RFP/R128S*</b>	47.25	31.5	43.25	19.75 x 19.75*	1620	2108
Rectangle	<b>RFP/R128C*</b>	47.25	31.5	43.25	23.5 dia	1628	2116
Rectangle	<b>RFP/R147S*</b>	55	27.5	43.25	19.75 x 19.75*	1638	2124
Rectangle	<b>RFP/R147C*</b>	55	27.5	43.25	23.5 dia*	1648	2134
Rectangle	<b>RFP/R168S*</b>	63	31.5	43.25	19.75 x 19.75*	1764	2144
Rectangle	<b>RFP/R168C*</b>	63	31.5	43.25	23.5 dia*	1770	2152

\*Table sizes 47.25" x 23.5" (1200 x 600mm) and above feature dual bases

Leather Square Footage Product Weight

REEF TABLE



### Poseur Table - Painted Frame Options

Colour Choice	RAL 9005	RAL 9016	RAL 9006	RAL 060 60 05	RAL 240 20 22	RAL 220 70 10	RAL 130 30 20	RAL 040 50 50	RAL 070 70 80
Suffix*	PF/B	PF/W	PF/SIL	PF/SG	PF/DB	PF/LB	PF/GN	PF/CR	PF/Y
\$	\$ inc	\$ inc	\$ inc	260	260	260	260	260	260

\*If table features two stems and bases, apply two painted upcharges.

### Options

CODE:	DESCRIPTION	\$
<b>POWER &amp; DATA</b> (SEE PAGES 528 FOR MORE OPTIONS - ADD \$124 TO COST OF POWER TO COVER UPGRADED COLUMN AND FOOT PLATE)	<b>Pixel unit - 1x US Power with TUF A+C</b> N.B. Price includes Base and Stem upgrade with internal cable management, tabletop cut out and 1x Pixel unit inc. 78.75"	385 + 124
	<b>ARC-H LD White/Gray</b> N.B. Price includes Base and Stem upgrade with internal cable management, tabletop cut out and 1x Pixel unit inc. 78.75"	260 + 124

CODE:	DESCRIPTION	\$
<b>RADIUS CORNERS</b>	3.25" Radius Corners	106
<b>CUSTOMERS OWN POWER</b>	Table Top cut out for customers own power	106

# Sol

Coffee & Side Table

boss





Calm, cool and considered, this lounge table collection exudes minimal elegance to suite in beautifully with a wide variety of seating designs.



## Range Information

- Coffee and Side table collection
- Tubular steel tripod leg frame
- Bull nose leg detail
- Metal base frames available in any of the standard Boss 8 RAL colors
- 3 standard table top finishes: Laminate, Veneer & Fenix
- Square or Chamfered edge
- Terazzo effect recycled plastic tops (as shown) are available as a special order and to set MOQ's. Please enquire for more information.



PRODUCT	Code:	Size L x W x H		Seats Approx.	Square OR Chamfered Edge			 (lb)
					Laminate 1"	Veneer 1"	Fenix 1"	
Coffee Table	<b>SOLC/C800</b>	800dia (31.5")	420mm (16.5")	2-4	2218	2280	3270	-
Side Table	<b>SOLS/C380</b>	380dia (15")	600mm (23.75")	2	1774	1824	2618	-

 Product Volume Inc. Packaging  Product Weight



### Painted Frame Options

Colour Choice	RAL 9005	RAL 9016	RAL 060 60 05	RAL 240 20 22	RAL 220 70 10	RAL 130 30 20	RAL 040 50 50	RAL 070 70 80
Suffix*	PF/B	PF/W	PF/SG	PF/DB	PF/LB	PF/GN	PF/CR	PF/Y
Coffee	inc	inc	inc	inc	inc	inc	inc	inc
Side Table	inc	inc	inc	inc	inc	inc	inc	inc

LOUNGE SEATING





## Range Information

- Available in Oak, American Black Walnut or to a painted finish (painted finish is \$236)
- Table top with 0.25" (7mm) dish recess
- A full range of line drawings and images in the Triad range can be downloaded from our website [bossdesign.com](http://bossdesign.com)



**LOW TABLE**



**DIMENSIONS**

Height: **500mm (19.75")**  
 Width: **390mm (15.25")**  
 Depth: **390mm (15.25")**

Code:	Description	\$	 (lb)
<b>TRI/1</b>	Triad low table, 19.75" (500mm) (H), Oak, timber top	868	
<b>TRI/4</b>	Triad low table, 19.75" (500mm) (H), American Black Walnut, timber top	958	
<b>TRI/7</b>	Triad low table, 19.75" (500mm) (H), Oak, white top As Shown	1080	
<b>TRI/10</b>	Triad low table, 500mm (H), American Black Walnut, white top	1114	

**MEDIUM TABLE**



**DIMENSIONS**

Height: **600mm (23.5")**  
 Width: **440mm (17.25")**  
 Depth: **440mm (17.25")**

Code:	Description	\$	 (lb)
<b>TRI/2</b>	Triad medium table, 23.5" (600mm) (H), Oak, timber top As Shown	1036	
<b>TRI/5</b>	Triad medium table, 23.5" (600mm) (H), American Black Walnut, timber top	1148	
<b>TRI/8</b>	Triad medium table, 23.5" (600mm) (H), Oak, white top	1170	
<b>TRI/11</b>	Triad medium table, 23.5" (600mm) (H), American Black Walnut, white top	1180	

**HIGH TABLE**



**DIMENSIONS**

Height: **725mm (28.5")**  
 Width: **540mm (21.25")**  
 Depth: **540mm (21.25")**

Code:	Description	\$	 (lb)
<b>TRI/3</b>	Triad high table, 28.5" (725mm) (H), Oak, timber top	1224	
<b>TRI/6</b>	Triad high table, 28.5" (725mm) (H), American Black Walnut, timber top	1448	
<b>TRI/9</b>	Triad high table, 28.5" (725mm) (H), Oak, white top As Shown	1336	
<b>TRI/12</b>	Triad high table, 28.5" (725mm) (H), American Black Walnut, white top	1404	

TABLES



08.

Storage



# Credenzas

Storage

boss





STORAGE



Our new Credenzas fuse contemporary design with versatile functionality to create a striking storage solution for the modern workspace.

# Credenzas

boss

## Storage

### Carcass

Stepped Mitred Edge  
3 Heights available  
21.5", 29.25" & 36.5"

3 Widths available  
40.25", 60" & 71.75"

5 popular configurations as standard

For other finishes or combinations, please contact sales office for more information [sales@bossdesign.com](mailto:sales@bossdesign.com)



### Door Info

Multiple finish and material options are available. Please see appendix for our full range of materials

Touch latch doors/drawers

### Optional

Door locks can be specified.  
Single door lock with 2x keys



### Foot and Base Options

#### Wooden Foot:

O - Oak  
ABW - American Black Walnut

#### Wire Foot:

FB - Black RAL 9005  
FW - White RAL 9016  
FS - Silver RAL 9006

#### Plinth:

P - Plinth  
PD - Plinth w/ matching Doors  
PC - Plinth w/ matching Carcass



Oak or ABW Foot



Wire Foot



Plinth Base

### Optional upgrades

An internal fridge unit with a capacity of 45L is only available on the 29.25"H & 36.5"H 'Door Only' credenza units

#### Available on the right hand side only

Fridge only available in White

Power and Data is available for specification (ventilation cut out is required). Please contact your sales representative for more information



## Detailed Specification

### Carcass

The Credenza carcass can be specified in Veneer, Laminate or Fenix as standard, using our standard finishes as shown on page 536.

Other finishes can be specified POA. Please contact sales@bossdesign.com for more information.

### Wooden Foot

- Oak
- American Black Walnut

### Wire Foot

#### Standard painted wire foot finishes:

- Black - RAL 9005
- White - RAL 9016
- Silver - RAL 9006

### Plinth finish

The plinth finish can either be matched to the carcass (PC) or to the doors/drawers (PD) - please specify using the suffix at time of ordering

### Carcass Edge Details

The thickness of the credenza range is 30mm thick across the whole range

### Credenza Power Options

Power is not a standard option on our credenza range however it can be specified, subject to compatibility. Please see our power and data pages for more information and contact sales office for more information, customerservice@bossdesign.com

### Fridge Unit

A 2 cubic foot fridge unit is available for order (29.25"H & 36.5"H units only). Cut out vents will be cut into the rear to provide ventilation for the fridge. **Available on the right hand side only**

**N.B. Fridge unit cannot be specified on 'doors & drawers' credenzas. See item options for availability.**

### Credenza Finish Combinations

#### All - Veneer - Boss Standard Options Only

Veneer carcass and veneer doors/drawers, veneer plinth.

#### All - Laminate - Boss Standard Options Only

Laminate carcass and laminate doors/drawers, laminate plinth.

#### All - Fenix Credenza - Boss Standard Options Only

Fenix carcass and Fenix doors/drawers, Fenix plinth. Internals in a matching complimentary laminate.

**Veneer Carcass & Fenix Doors - Boss Standard Options Only** Veneer carcass with Fenix plinth, doors/drawers

**OR**

Veneer carcass with veneer plinth, Fenix doors/drawers

#### Veneer Carcass & Laminate Doors - Boss Standard Options Only

Veneer carcass with laminate plinth, doors/drawers

**OR**

Veneer carcass with veneer plinth, laminate door/drawers.

### Credenza Digital Assets

We hold a library of assets for our Deploy product range which you can find by scanning the the QR code below. If you are viewing our interactive PDF, simply click on the QR code to be taken directly there.



### Edge Details

Stepped mitre

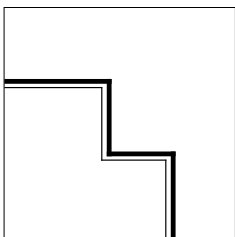

Side Profile

### RAL Colors\*

Standard Wire Feet Finish Colors

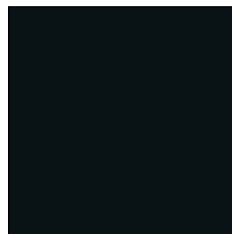

Black RAL 9005

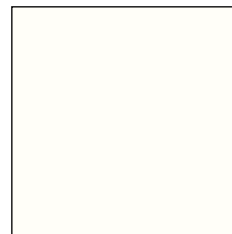

White RAL 9016

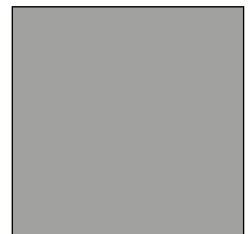

Silver RAL 9006

\*Due to the printing process, colors are approximate. Please view an RAL color chart for accurate color representation

# Credenzas – Wooden Feet

boss

Storage



## Doors Only

A complete and detailed list of sizes and specifications can be viewed by scanning the QR code below.

If you are viewing this digitally, simply click the QR code below.

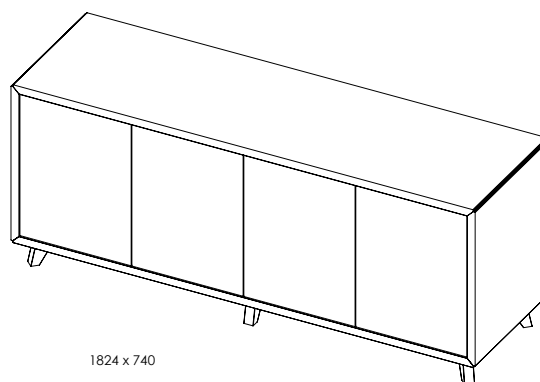

1824 x 740

## Doors & Drawers

A complete and detailed list of sizes and specifications can be viewed by scanning the QR code below.

If you are viewing this digitally, simply click the QR code below.

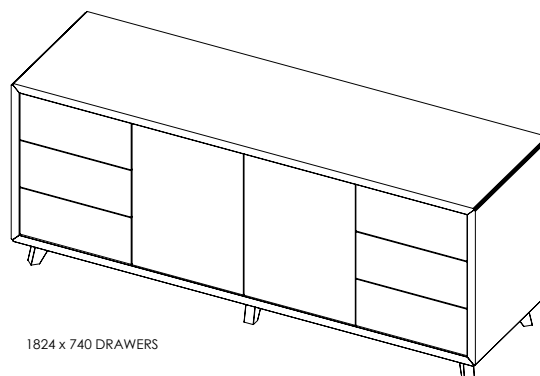

1824 x 740 DRAWERS

**CREDENZA 21.5"H  
WOODEN FEET**

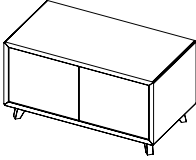
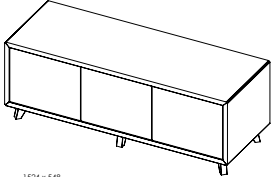
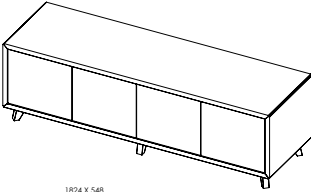
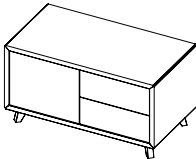
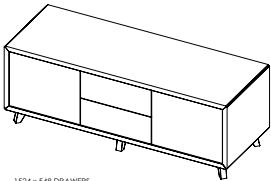
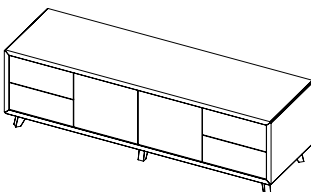
	Code	Size W x D x H			All Veneer	All Laminate	All Fenix	Veneer Carcass Fenix Doors	Veneer Carcass Laminate Doors	 (lb)
 <small>1024 x 548</small>	<b>BC105/2D/...</b> <b>OAK OR ABW</b>	40.25"	21.75"	21.5"	5208	4934	5710	5254	5064	
	<b>Description</b> 2 Door Credenza unit with wooden feet Adjustable internal shelving included									
 <small>1524 x 548</small>	<b>BC155/3D/...</b> <b>OAK OR ABW</b>	60"	21.75"	21.5"	6868	6300	7552	6962	6686	
	<b>Description</b> 3 Door Credenza unit with wooden feet Adjustable internal shelving included									
 <small>1824 X 548</small>	<b>BC185/4D/...</b> <b>OAK OR ABW</b>	71.75"	21.75"	21.5"	6868	6300	7552	6962	6686	
	<b>Description</b> 4 Door Credenza unit with wooden feet Adjustable internal shelving included									
 <small>1024 x 548 DRAWERS</small>	<b>BC105/1D/...</b> <b>OAK OR ABW</b>	40.25"	21.75"	21.5"	6082	5780	6556	6018	5906	
	<b>Description</b> 1 Door, 2 drawer Credenza unit with wooden feet Adjustable internal shelving included									
 <small>1524 x 548 DRAWERS</small>	<b>BC155/2D/...</b> <b>OAK OR ABW</b>	60"	21.75"	21.5"	7298	6966	8098	7454	7096	
	<b>Description</b> 2 Door, 2 drawer Credenza unit with wooden feet Adjustable internal shelving included									
 <small>1824 X 548 DRAWERS</small>	<b>BC185/2D/...</b> <b>OAK OR ABW</b>	71.75"	21.75"	21.5"	8600	7964	9216	8472	8358	
	<b>Description</b> 2 Door, 4 drawer Credenza unit with wooden feet Adjustable internal shelving included									

STORAGE

 Product Volume Inc. Packaging  Product Weight

**Options**

CODE:	DESCRIPTION	\$
<b>NS DC</b>	Non standard Door Colors - See page 536 for our entire range of finish options	POA
<b>V</b>	Ventilation Cut Out	576
<b>DOOR LOCK</b>	Lockable Doors with key(s) Per Door	30

CODE:	DESCRIPTION	\$
<b>FRH</b>	Fridge Unit (Ventilation Cut Out included) Only available on Door Only Credenzas Fridge takes up 1.5 door spaces	1162
<b>P&amp;D</b>	Power and Data is available - please contact your customer service to discuss your requirements	See page 524

## CREDENZA 29.25"H WOODEN FEET

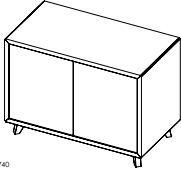
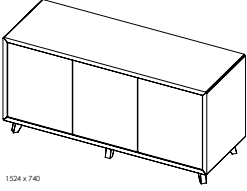
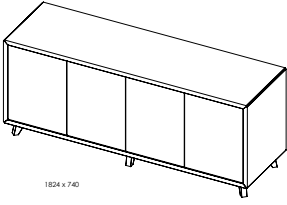
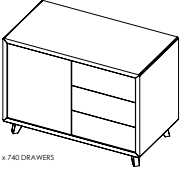
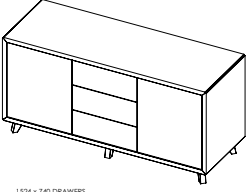
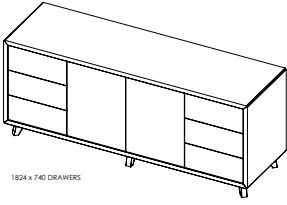
	Code	Size W x D x H			All Veneer	All Laminate	All Fenix	Veneer Carcass Fenix Doors	Veneer Carcass Laminate Doors	(lb)
 1024 x 740	<b>BC107/2D/...</b> <b>OAK OR ABW</b>	40.25"	21.75"	29.25"	5184	5052	5918	5442	5044	
<b>Description</b> 2 Door Credenza unit with wooden feet Adjustable internal shelving included										
 1524 x 740	<b>BC157/3D/...</b> <b>OAK OR ABW</b>	60"	21.75"	29.25"	6576	6194	7408	6830	6396	
<b>Description</b> 3 Door Credenza unit with wooden feet Adjustable internal shelving included										
 1824 x 740	<b>BC187/4D/...</b> <b>OAK OR ABW</b>	71.75"	21.75"	29.25"	7036	6404	7746	7138	6846	
<b>Description</b> 4 Door Credenza unit with wooden feet Adjustable internal shelving included										
 1024 x 740 DRAWERS	<b>BC107/1D/...</b> <b>OAK OR ABW</b>	40.25"	21.75"	29.25"	6482	6312	7170	6572	6296	
<b>Description</b> 1 Door & 3 Drawer Credenza unit with wooden feet Adjustable internal shelving included										
 1524 x 740 DRAWERS	<b>BC157/2D/...</b> <b>OAK OR ABW</b>	60"	21.75"	29.25"	7878	7446	8658	7960	7660	
<b>Description</b> 2 Door & 3 Drawer Credenza unit with wooden feet Adjustable internal shelving included										
 1824 x 740 DRAWERS	<b>BC187/2D/...</b> <b>OAK OR ABW</b>	71.75"	21.75"	29.25"	9642	8916	10258	9408	9360	
<b>Description</b> 2 Door & 6 Drawer Credenza unit with wooden feet Adjustable internal shelving included										

 Product Volume Inc. Packaging  Product Weight

## Options

CODE:	DESCRIPTION	\$	CODE:	DESCRIPTION	\$
<b>NS DC</b>	Non standard Door Colors - See page 536 for our entire range of finish options	POA	<b>FRH</b>	Fridge Unit (Ventilation Cut Out included) Only available on Door Only Credenzas Fridge takes up 1.5 door spaces	
<b>V</b>	Ventilation Cut Out		<b>P&amp;D</b>	Power and Data is available - please contact your customer service to discuss your requirements	See page 524
<b>DOOR LOCK</b>	Lockable Doors with key(s) Per Door				

**CREDENZA 36.5"H  
WOODEN FEET**

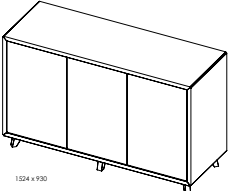
	Code	Size W x D x H			All Veneer	All Laminate	All Fenix	Veneer Carcass Fenix Doors	Veneer Carcass Laminate Doors	(lb)
 1024 x 930	<b>BC109/2D/...</b> <b>OAK OR ABW</b>	40.25"	21.75"	36.5"	5328	5094	5952	5476	5176	
	<b>Description</b> 2 Door Credenza unit with wooden feet Adjustable internal shelving included									
 1024 x 930	<b>BC159/3D/...</b> <b>OAK OR ABW</b>	60"	21.75"	36.5"	6974	6322	7536	6942	6784	
	<b>Description</b> 3 Door Credenza unit with wooden feet Adjustable internal shelving included									

 Product Volume Inc. Packaging  Product Weight

**Options**

CODE:	DESCRIPTION	\$
<b>NS DC</b>	Non standard Door Colors - See page 536 for our entire range of finish options	POA
<b>V</b>	Ventilation Cut Out	576
<b>DOOR LOCK</b>	Lockable Doors with key(s) Per Door	30

CODE:	DESCRIPTION	\$
<b>FRH</b>	Fridge Unit (Ventilation Cut Out included) Only available on Door Only Credenzas Fridge takes up 1.5 door spaces	1162
<b>P&amp;D</b>	Power and Data is available - please contact your customer service to discuss your requirements	See page 524

STORAGE

# Credenzas – Wire Feet

boss

Storage



## Doors Only

A complete and detailed list of sizes and specifications can be viewed by scanning the QR code below.

If you are viewing this digitally, simply click the QR code below.



**Carcass:** Black Laminate  
**Door Finish:** Designer White Laminate

## Doors & Drawers

A complete and detailed list of sizes and specifications can be viewed by scanning the QR code below.

If you are viewing this digitally, simply click the QR code below.



**Carcass:** Designer White Laminate  
**Door Finish:** Beech Veneer

**CREDENZA 21.5"H  
WIRE FEET**

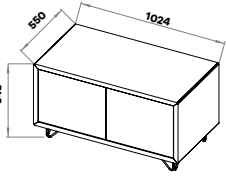
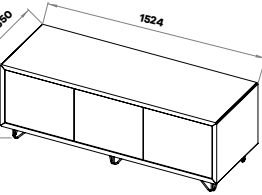
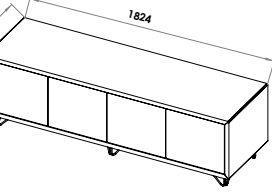
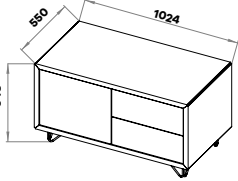
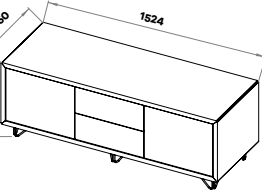
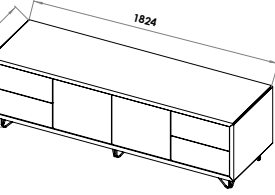
	Code	Size W x D x H			All Veneer	All Laminate	All Fenix	Veneer Carcass Fenix Doors	Veneer Carcass Laminate Doors
	<b>BC105/2D/...</b> <b>FOOT TYPE &amp; COLOR/</b>	40.25"	21.75"	21.5"	4896	4610	5386	4926	4732
	<b>Description</b> 2 Door Credenza unit with wire feet Adjustable internal shelving included Black, White or Silver feet as standard.			<b>Foot Suffix's</b> FW - Wire Foot White FB - Wire Foot Black FS - Wire Foot Silver					
	<b>BC155/3D/...</b> <b>FOOT TYPE &amp; COLOR/</b>	60"	21.75"	21.5"	5718	5398	6522	5960	5528
	<b>Description</b> 3 Door Credenza unit with wire feet Adjustable internal shelving included Black, White or Silver feet as standard.			<b>Foot Suffix's</b> FW - Wire Foot White FB - Wire Foot Black FS - Wire Foot Silver					
	<b>BC185/4D/...</b> <b>FOOT TYPE &amp; COLOR/</b>	71.75"	21.75"	21.5"	6148	5558	6814	6226	5944
	<b>Description</b> 4 Door Credenza unit with wire feet Adjustable internal shelving included Black, White or Silver feet as standard.			<b>Foot Suffix's</b> FW - Wire Foot White FB - Wire Foot Black FS - Wire Foot Silver					
	<b>BC105/1D/...</b> <b>FOOT TYPE &amp; COLOR/</b>	40.25"	21.75"	21.5"	5770	5454	6230	5692	5582
	<b>Description</b> 1 Door, 2 drawer Credenza unit with wire feet Adjustable internal shelving included Black, White or Silver feet as standard.			<b>Foot Suffix's</b> FW - Wire Foot White FB - Wire Foot Black FS - Wire Foot Silver					
	<b>BC155/2D/...</b> <b>FOOT TYPE &amp; COLOR/</b>	60"	21.75"	21.5"	6576	6234	7356	6712	6354
	<b>Description</b> 2 Door, 2 drawer Credenza unit with wire feet Adjustable internal shelving included Black, White or Silver feet as standard.			<b>Foot Suffix's</b> FW - Wire Foot White FB - Wire Foot Black FS - Wire Foot Silver					
	<b>BC185/2D/...</b> <b>FOOT TYPE &amp; COLOR/</b>	71.75"	21.75"	21.5"	7882	7232	8484	7730	7622
	<b>Description</b> 2 Door, 4 drawer Credenza unit with wire feet Adjustable internal shelving included Black, White or Silver feet as standard.			<b>Foot Suffix's</b> FW - Wire Foot White FB - Wire Foot Black FS - Wire Foot Silver					

STORAGE

 Product Volume Inc. Packaging  Product Weight

**Options**

CODE:	DESCRIPTION	\$	CODE:	DESCRIPTION	\$
<b>NS DC</b>	Non standard Door Colors - See page 536 for our entire range of finish options	POA	<b>FRH</b>	Fridge Unit (Ventilation Cut Out included) Only available on Door Only Credenzas Fridge takes up 1.5 door spaces	1162
<b>V</b>	Ventilation Cut Out	576	<b>P&amp;D</b>	Power and Data is available - please contact your customer service to discuss your requirements	See page 524
<b>DOOR LOCK</b>	Lockable Doors with key(s) Per Door	30			

**CREDENZA 29.25" H  
WIRE FEET**

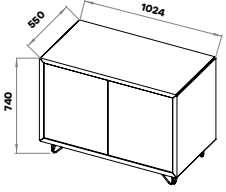
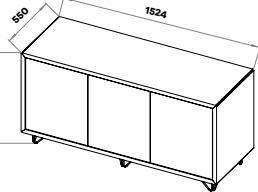
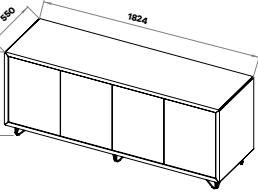
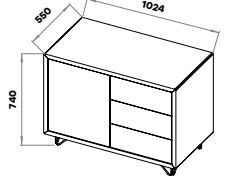
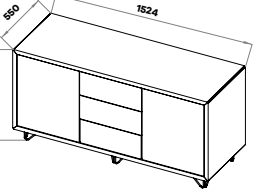
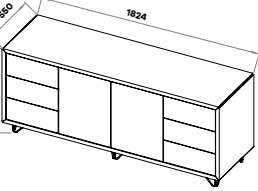
	Code	Size W x D x H			All Veneer	All Laminate	All Fenix	Veneer Carcass Fenix Doors	Veneer Carcass Laminate Doors	(lb)
	<b>BC107/2D/...</b> <b>FOOT TYPE &amp; COLOR/</b>	40.25"	21.75"	29.25"	4876	4720	5590	5110	4712	
	<b>Description</b>				<b>Foot Suffix's</b>					
2 Door Credenza unit with wire feet Adjustable internal shelving included Black, White or Silver feet as standard.				FW - Wire Foot White FB - Wire Foot Black FS - Wire Foot Silver						
	<b>BC157/3D/...</b> <b>FOOT TYPE &amp; COLOR/</b>	60"	21.75"	29.25"	5858	5458	6670	6092	5664	
	<b>Description</b>				<b>Foot Suffix's</b>					
3 Door Credenza unit with wire feet Adjustable internal shelving included Black, White or Silver feet as standard.				FW - Wire Foot White FB - Wire Foot Black FS - Wire Foot Silver						
	<b>BC187/4D/...</b> <b>FOOT TYPE &amp; COLOR/</b>	71.75"	21.75"	29.25"	6318	5672	7010	6400	6108	
	<b>Description</b>				<b>Foot Suffix's</b>					
4 Door Credenza unit with wire feet Adjustable internal shelving included Black, White or Silver feet as standard.				FW - Wire Foot White FB - Wire Foot Black FS - Wire Foot Silver						
	<b>BC107/1D/...</b> <b>FOOT TYPE &amp; COLOR/</b>	40.25"	21.75"	29.25"	6174	5984	6846	6248	5968	
	<b>Description</b>				<b>Foot Suffix's</b>					
1 Door & 3 Drawer Credenza unit with wire feet Adjustable internal shelving included Black, White or Silver feet as standard.				FW - Wire Foot White FB - Wire Foot Black FS - Wire Foot Silver						
	<b>BC157/2D/...</b> <b>FOOT TYPE &amp; COLOR/</b>	60"	21.75"	29.25"	7158	6708	7922	7228	6940	
	<b>Description</b>				<b>Foot Suffix's</b>					
2 Door & 3 Drawer Credenza unit with wire feet Adjustable internal shelving included Black, White or Silver feet as standard.				FW - Wire Foot White FB - Wire Foot Black FS - Wire Foot Silver						
	<b>BC187/2D/...</b> <b>FOOT TYPE &amp; COLOR/</b>	71.75"	21.75"	29.25"	8920	8184	9516	8670	8624	
	<b>Description</b>				<b>Foot Suffix's</b>					
2 Door & 6 Drawer Credenza unit with wire feet Adjustable internal shelving included Black, White or Silver feet as standard.				FW - Wire Foot White FB - Wire Foot Black FS - Wire Foot Silver						

 Product Volume Inc. Packaging  Product Weight

**Options**

CODE:	DESCRIPTION	\$	CODE:	DESCRIPTION	\$
<b>NS DC</b>	Non standard Door Colors - See page 536 for our entire range of finish options	POA	<b>FRH</b>	Fridge Unit (Ventilation Cut Out included) Only available on Door Only Credenzas Fridge takes up 1.5 door spaces	
<b>V</b>	Ventilation Cut Out		<b>P&amp;D</b>	Power and Data is available - please contact your customer service to discuss your requirements	See page 524
<b>DOOR LOCK</b>	Lockable Doors with key(s) Per Door				

**CREDENZA 36.5"H  
WIRE FEET**

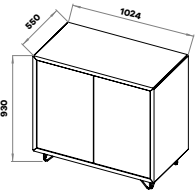
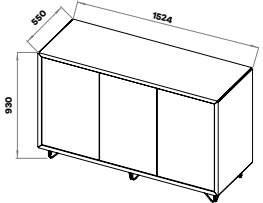
	Code	Size W x D x H			All Veneer	All Laminate	All Fenix	Veneer Carcass Fenix Doors	Veneer Carcass Laminate Doors	(lb)
	<b>BC109/2D/...</b> <b>FOOT TYPE &amp; COLOR/</b>	40.25"	21.75"	36.5"	5020	4762	5628	5148	4852	
	<b>Description</b> 2 Door Credenza unit with wire feet Adjustable internal shelving included Black, White or Silver feet as standard.	<b>Foot Suffix's</b> FW - Wire Foot White FB - Wire Foot Black FS - Wire Foot Silver								
	<b>BC159/3D/...</b> <b>FOOT TYPE &amp; COLOR/</b>	60"	21.75"	36.5"	6256	5586	6798	6210	6050	
	<b>Description</b> 3 Door Credenza unit with wire feet Adjustable internal shelving included Black, White or Silver feet as standard.	<b>Foot Suffix's</b> FW - Wire Foot White FB - Wire Foot Black FS - Wire Foot Silver								

 Product Volume Inc. Packaging  Product Weight

**Options**

CODE:	DESCRIPTION	\$
<b>NS DC</b>	Non standard Door Colors - See page 536 for our entire range of finish options	POA
<b>V</b>	Ventilation Cut Out	576
<b>DOOR LOCK</b>	Lockable Doors with key(s) Per Door	30

CODE:	DESCRIPTION	\$
<b>FRH</b>	Fridge Unit (Ventilation Cut Out included) Only available on Door Only Credenzas Fridge takes up 1.5 door spaces	1162
<b>P&amp;D</b>	Power and Data is available - please contact your customer service to discuss your requirements	See page 524



STORAGE

# Credenzas – Plinth Base

boss

Storage



## Doors Only

A complete and detailed list of sizes and specifications can be viewed by scanning the QR code below.

If you are viewing this digitally, simply click the QR code below.



## Doors & Drawers

A complete and detailed list of sizes and specifications can be viewed by scanning the QR code below.

If you are viewing this digitally, simply click the QR code below.

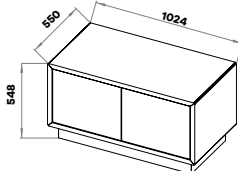
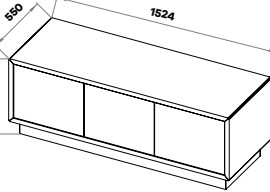
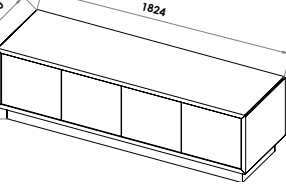
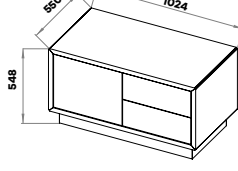
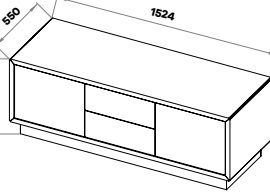
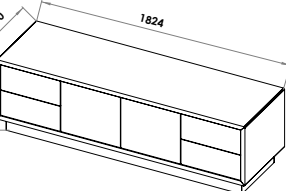

**CREDENZA 21.5"H  
PLINTH BASE**

	Code	Size W x D x H			All Veneer	All Laminate	All Fenix	Veneer Carcass Fenix Doors	Veneer Carcass Laminate Doors	 (lb)
	<b>BC105/2D/...</b> <b>PLINTH OPTION/</b>	40.25"	21.75"	21.5"	4350	4076	4852	4396	4206	
	<b>Description</b> 2 Door Credenza unit with plinth base Adjustable internal shelving included			<b>Plinth Suffix's</b> P - Plinth PD - Plinth & Doors match PC - Plinth & Carcass match						
	<b>BC155/3D/...</b> <b>PLINTH OPTION/</b>	60"	21.75"	21.5"	5168	4868	5996	5430	5000	
	<b>Description</b> 3 Door Credenza unit with plinth base Adjustable internal shelving included			<b>Plinth Suffix's</b> P - Plinth PD - Plinth & Doors match PC - Plinth & Carcass match						
	<b>BC185/4D/...</b> <b>PLINTH OPTION/</b>	71.75"	21.75"	21.5"	5602	5032	6284	5694	5418	
	<b>Description</b> 4 Door Credenza unit with plinth base Adjustable internal shelving included			<b>Plinth Suffix's</b> P - Plinth PD - Plinth & Doors match PC - Plinth & Carcass match						
	<b>BC105/1D/...</b> <b>PLINTH OPTION/</b>	40.25"	21.75"	21.5"	5224	4922	5698	5160	5048	
	<b>Description</b> 1 Door, 2 drawer Credenza unit with plinth base Adjustable internal shelving included			<b>Plinth Suffix's</b> P - Plinth PD - Plinth & Doors match PC - Plinth & Carcass match						
	<b>BC155/2D/...</b> <b>PLINTH OPTION/</b>	60"	21.75"	21.5"	6030	5698	6830	6186	5828	
	<b>Description</b> 2 Door, 2 drawer Credenza unit with plinth base Adjustable internal shelving included			<b>Plinth Suffix's</b> P - Plinth PD - Plinth & Doors match PC - Plinth & Carcass match						
	<b>BC185/2D/...</b> <b>PLINTH OPTION/</b>	71.75"	21.75"	21.5"	7332	6698	7950	7204	7092	
	<b>Description</b> 2 Door, 4 drawer Credenza unit with plinth base Adjustable internal shelving included			<b>Plinth Suffix's</b> P - Plinth PD - Plinth & Doors match PC - Plinth & Carcass match						

STORAGE

 Product Volume Inc. Packaging  Product Weight

**Options**

CODE:	DESCRIPTION	\$
<b>NS DC</b>	Non standard Door Colors - See page 536 for our entire range of finish options	POA
<b>V</b>	Ventilation Cut Out	576
<b>DOOR LOCK</b>	Lockable Doors with key(s) Per Door	30

CODE:	DESCRIPTION	\$
<b>FRH</b>	Fridge Unit (Ventilation Cut Out included) Only available on Door Only Credenzas Fridge takes up 1.5 door spaces	1162
<b>P&amp;D</b>	Power and Data is available - please contact your customer service to discuss your requirements	See page 524

## CREDENZA 29.25"H PLINTH BASE

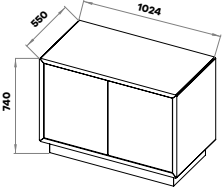
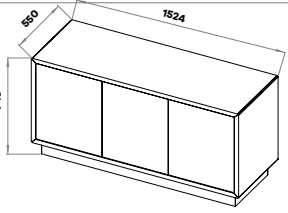
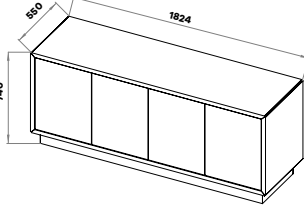
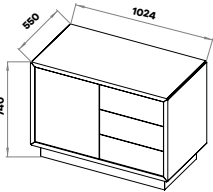
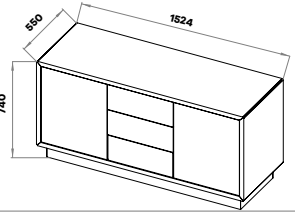
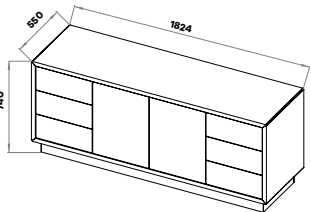
	Code	Size W x D x H			All Veneer	All Laminate	All Fenix	Veneer Carcass Fenix Doors	Veneer Carcass Laminate Doors	(lb)
	<b>BC107/2D/...</b> <b>PLINTH OPTION/</b>	40.25"	21.75"	29.25"	4326	4194	5060	4584	4186	
	<b>Description</b>			<b>Plinth Suffix's</b>						
2 Door Credenza unit with plinth base Adjustable internal shelving included			P - Plinth PD - Plinth & Doors match PC - Plinth & Carcass match							
	<b>BC157/3D/...</b> <b>PLINTH OPTION/</b>	60"	21.75"	29.25"	5308	4926	6140	5562	5130	
	<b>Description</b>			<b>Plinth Suffix's</b>						
3 Door Credenza unit with plinth base Adjustable internal shelving included			P - Plinth PD - Plinth & Doors match PC - Plinth & Carcass match							
	<b>BC187/4D/...</b> <b>PLINTH OPTION/</b>	71.75"	21.75"	29.25"	5770	5138	6478	5870	5578	
	<b>Description</b>			<b>Plinth Suffix's</b>						
4 Door Credenza unit with plinth base Adjustable internal shelving included			P - Plinth PD - Plinth & Doors match PC - Plinth & Carcass match							
	<b>BC107/1D/...</b> <b>PLINTH OPTION/</b>	40.25"	21.75"	29.25"	5624	5454	6312	5714	5438	
	<b>Description</b>			<b>Plinth Suffix's</b>						
1 Door & 3 Drawer Credenza unit with plinth base Adjustable internal shelving included			P - Plinth PD - Plinth & Doors match PC - Plinth & Carcass match							
	<b>BC157/2D/...</b> <b>PLINTH OPTION/</b>	60"	21.75"	29.25"	6612	6178	7392	6694	6394	
	<b>Description</b>			<b>Plinth Suffix's</b>						
2 Door & 3 Drawer Credenza unit with plinth base Adjustable internal shelving included			P - Plinth PD - Plinth & Doors match PC - Plinth & Carcass match							
	<b>BC187/...</b> <b>PLINTH OPTION/</b>	71.75"	21.75"	29.25"	8374	7648	8990	8140	8094	
	<b>Description</b>			<b>Plinth Suffix's</b>						
2 Door & 6 Drawer Credenza unit with plinth base Adjustable internal shelving included			P - Plinth PD - Plinth & Doors match PC - Plinth & Carcass match							

 Product Volume Inc. Packaging  Product Weight

## Options

CODE:	DESCRIPTION	\$
<b>NS DC</b>	Non standard Door Colors - See page 536 for our entire range of finish options	POA
<b>V</b>	Ventilation Cut Out	576
<b>DOOR LOCK</b>	Lockable Doors with key(s) Per Door	30

CODE:	DESCRIPTION	\$
<b>FRH</b>	Fridge Unit (Ventilation Cut Out included) Only available on Door Only Credenzas Fridge takes up 1.5 door spaces	1162
<b>P&amp;D</b>	Power and Data is available - please contact your customer service to discuss your requirements	See page 524

**CREENZA 36.5"H  
PLINTH BASE**

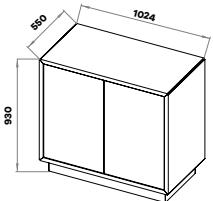
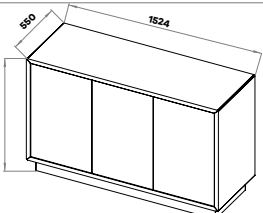
	Code	Size W x D x H			All Veneer	All Laminate	All Fenix	Veneer Carcass Fenix Doors	Veneer Carcass Laminate Doors	 (lb)
	<b>BC109/2D/...</b> <b>PLINTH OPTION/</b>	40.25"	21.75"	36.5"	4470	4236	5094	4618	4318	
	<b>Description</b> 2 Door Credenza unit with plinth base Adjustable internal shelving included				<b>Plinth Suffix's</b> P - Plinth PD - Plinth & Doors match PC - Plinth & Carcass match					
	<b>BC159/3D/...</b> <b>PLINTH OPTION/</b>	60"	21.75"	36.5"	5706	5056	6268	5676	5516	
	<b>Description</b> 3 Door Credenza unit with plinth base Adjustable internal shelving included				<b>Plinth Suffix's</b> P - Plinth PD - Plinth & Doors match PC - Plinth & Carcass match					

 Product Volume Inc. Packaging  Product Weight

**Options**

CODE:	DESCRIPTION	\$
<b>NS DC</b>	Non standard Door Colors - See page 536 for our entire range of finish options	POA
<b>V</b>	Ventilation Cut Out	576
<b>DOOR LOCK</b>	Lockable Doors with key(s) Per Door	30

CODE:	DESCRIPTION	\$
<b>FRH</b>	Fridge Unit (Ventilation Cut Out included) Only available on Door Only Credenzas Fridge takes up 1.5 door spaces	1162
<b>P&amp;D</b>	Power and Data is available - please contact your customer service to discuss your requirements	See page 524



STORAGE



09.

Pods

# Scene

Pods

boss



Scene is a unique freestanding system providing the perfect space for focus working and collaboration. Scene affords the intimacy and privacy that is vital for today's workplace.



SCENE PODS



## Range Information



Occupancy: 2 to 10 people



Acoustic rated up to 37 dB (excluding Aspect 360)

- Horizontal Beam lighting system.
- Acoustic fully upholstered walls
- Toughened frameless clear glass featuring 2 levels of white line manifestations.
- Integrated power arch
- Acoustic ceiling panels
- Clear glass sliding door with soft open/close
- Active PIR motion/occupancy sensor (passive infrared)
- **N.B. Acoustic performance is maximized when the pods are positioned on a carpeted surface and acoustic roof mat is selected.**





Model	Typical Occupancy	Frame Dimensions (H x W x D)	Price Grade 1 Fabric	Price Grade 2 Fabric	Price Grade 3 Fabric
SCENE 1		89.5 x 79 x 59"	35,704	36,000	36,742

**Standard Specification**

- Horizontal Beam Lighting.
- Acoustic fully upholstered 59" (1500mm) walls
- 0.25" toughened frameless clear glass 79" (2007mm) walls featuring 2 levels of DDA compliant manifestations.
- 1 x Power arch with 1 x CAT6 power & data panel (2 power 2 data)
- Acoustic ceiling panels upholstered in Camira Nexus Chalk.
- 1 x 0.4" clear glass sliding door with soft open and close to include 2 levels of manifestations.
- 1 x Active PIR motion/occupancy sensor (passive infrared)
- 1.5" Satin Silver Anodised Aluminum frame
- 4" high aluminum extrusion crown as standard

**Options**

Options	\$
Select the Weather Lighting	1741
Airflow unit 10,595-12,713 ft <sup>3</sup> /h	1597
Oak Fluted wall panels (per pod)	4495
Oak Smooth wall panels (per pod)	3917
Writeable glass (internal upgrade from acoustic)	380
Magnetic writeable glass (internal upgrade from acoustic)	1329
Powder coating	2579
Sliding ventilation beam	1046
Work hub table upgrade	551
Acoustic roof mat	556
AV Upgrade 1	2324
AV Upgrade 2	2611
AV Upgrade 3	2431

SCENE PODS

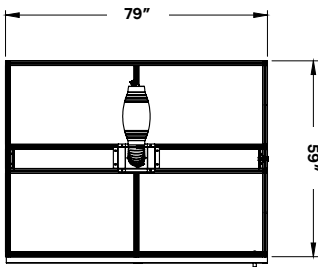

Acoustic performance is maximized when the pods are positioned on a carpeted surface, and when the acoustic roof mat is specified.

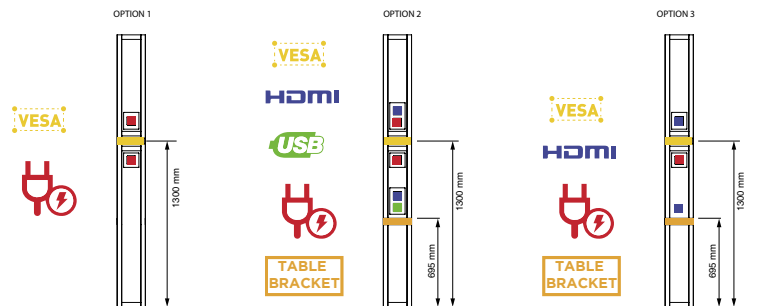

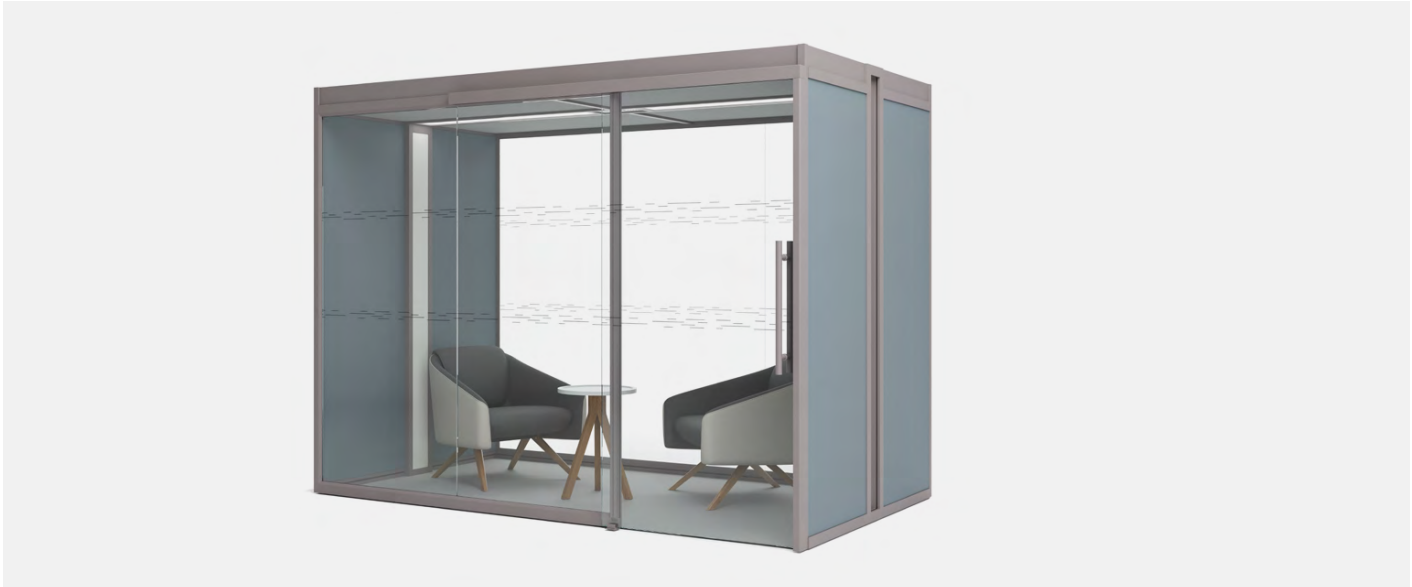

Model	Typical Occupancy	Frame Dimensions (H x W x D)	Price Grade 1 Fabric	Price Grade 2 Fabric	Price Grade 3 Fabric
SCENE 2		89.5 x 118 x 67"	36,060	37,773	38,245

**Standard Specification**

- Horizontal Beam Lighting.
- Acoustic fully upholstered 67" (1700mm) walls
- 0.25" (0.25") toughened frameless clear glass 118" (3000mm) walls featuring 2 levels of DDA compliant White line manifestations.
- 1 x Power arch with 1 x CAT6 power & data panel (2 power 2 data)
- Acoustic ceiling panels upholstered in Camira Nexus Chalk.
- 1 x 0.4" clear glass sliding door with soft open and close to include 2 levels of manifestations.
- 1 x Active PIR motion/occupancy sensor (passive infrared)
- 1.5" Satin Silver Anodised Aluminum frame
- 4" high aluminum extrusion crown as standard

**Options**

Options	\$
Select the Weather Lighting	1880
Airflow unit 10,595-12,713 ft <sup>3</sup> /h	1597
Oak Fluted wall panels (per pod)	4495
Oak Smooth wall panels (per pod)	3917
Writeable glass (internal upgrade from acoustic)	380
Magnetic writeable glass (internal upgrade from acoustic)	1329
Powder coating	2843
Sliding ventilation beam	1046
Acoustic roof mat	1111
AV Upgrade 1	2324
AV Upgrade 2	2611
AV Upgrade 3	2431

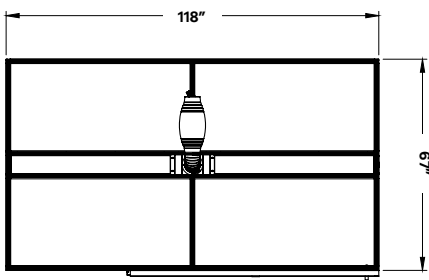

Acoustic performance is maximised when the pods are positioned on a carpeted surface, and when the acoustic roof mat is specified.

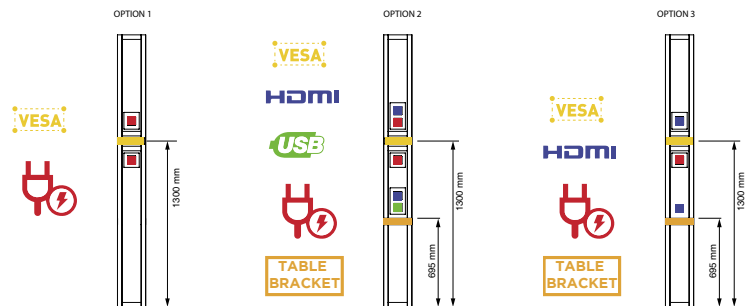



Model	Typical Occupancy	Frame Dimensions (H x W x D)	Price Grade 1 Fabric	Price Grade 2 Fabric	Price Grade 3 Fabric
SCENE 3	👤 👤 👤 👤	89.5 x 118 x 105.5"	38,500	39,194	39,667

**Standard Specification**

- Horizontal Beam Lighting
- Acoustic fully upholstered 105.5" (2680mm) walls
- 0.25" (0.25") toughened frameless clear glass 118" (3000mm) walls featuring 2 levels of DDA compliant White line manifestations
- 1 x Power arch with 1 x CAT6 power & data panel (2 power 2 data)
- Acoustic ceiling panels upholstered in Camira Nexus Chalk
- 1 x 0.4" clear glass sliding door with soft open and close to include 2 levels of manifestations
- 1 x Active PIR motion/occupancy sensor (passive infrared)
- 1.5" Satin Silver Anodised Aluminum frame
- 4" high aluminum extrusion crown as standard

**Options**

	\$
Select the Weather Lighting	1880
Airflow unit 10,595-12,713 ft³/h	1597
Oak Fluted wall panels (per pod)	6671
Oak Smooth wall panels (per pod)	5801
Writeable glass (internal upgrade from acoustic)	380
Magnetic writeable glass (internal upgrade from acoustic)	1329
Powder coating	3079
Sliding ventilation beam	1046
Acoustic roof mat	1111
AV Upgrade 1	2324
AV Upgrade 2	2611
AV Upgrade 3	2431

SCENE PODS

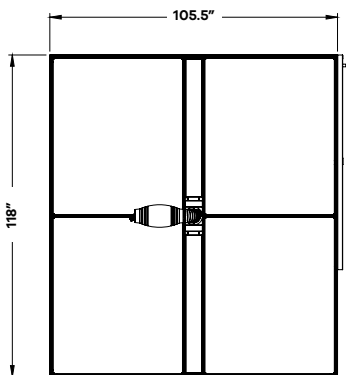

Acoustic performance is maximised when the pods are positioned on a carpeted surface, and when the acoustic roof mat is specified.

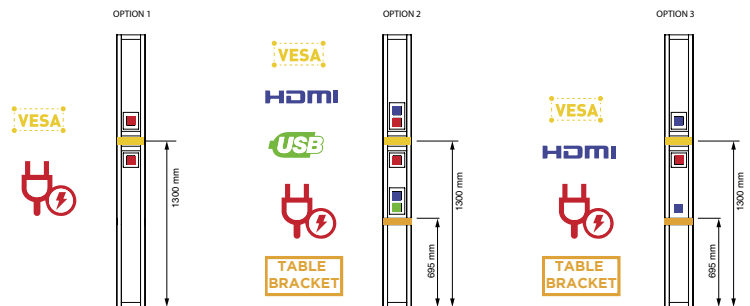



Model	Typical Occupancy	Frame Dimensions (H x W x D)	Price Grade 1 Fabric	Price Grade 2 Fabric	Price Grade 3 Fabric
SCENE 4		89.5 x 118 x 161.25"	55,023	56,412	57,120

**Standard Specification**

- Horizontal Beam Lighting
- Acoustic fully upholstered 161.25" (4095mm) walls
- 0.25" (0.25") toughened frameless clear glass 3000mm walls featuring 2 levels of DDA compliant White line manifestations
- 2 x Power arches with 2 x CAT6 power & data panels (2 power 2 data)
- Acoustic ceiling panels upholstered in Camira Nexus Chalk
- 1 x 0.4" clear glass sliding door with soft open and close to include 2 levels of manifestations
- 1 x Active PIR motion/occupancy sensor (passive infrared)
- 1.5" Satin Silver Anodised Aluminum frame
- 4" high aluminum extrusion crown as standard

**Options**

Options	\$
Select the Weather Lighting	3542
Airflow unit 10,595-12,713 ft <sup>3</sup> /h	3194
Oak Fluted wall panels (per pod)	8907
Oak Smooth wall panels (per pod)	7801
Writeable glass (internal upgrade from acoustic)	380
Magnetic writeable glass (internal upgrade from acoustic)	1329
Powder coating	4616
Sliding ventilation beam	1648
Acoustic roof mat	1653
AV Upgrade 1	2324
AV Upgrade 2	2611
AV Upgrade 3	2431

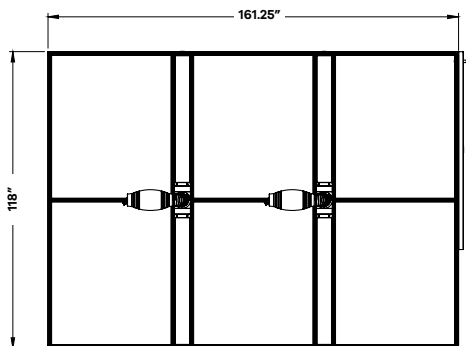

Acoustic performance is maximised when the pods are positioned on a carpeted surface, and when the acoustic roof mat is specified.

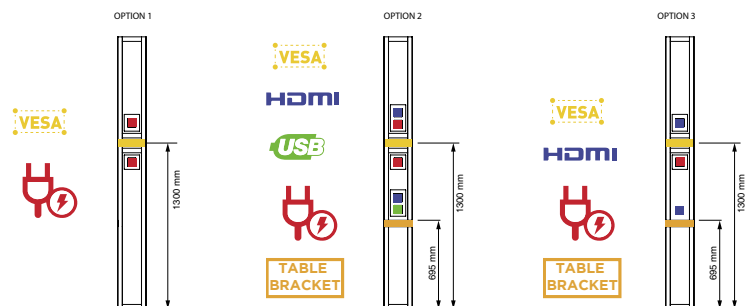



Model	Typical Occupancy	Frame Dimensions (H x W x D)	Price Grade 1 Fabric	Price Grade 2 Fabric	Price Grade 3 Fabric
SCENE 5		89.5 x 157.5 x 105.5"	51,125	52,051	52,523

**Standard Specification**

- Horizontal Beam Lighting
- Acoustic fully upholstered 105.5" (2680mm) walls
- 0.25" (0.25") toughened frameless clear glass 118" (3000mm) walls featuring 2 levels of DDA compliant White line manifestations
- 1 x Power arches with 1 x CAT6 power & data panels (2 power 2 data)
- Acoustic ceiling panels upholstered in Camira Nexus Chalk
- 1 x 0.4" clear glass sliding door with soft open and close to include 2 levels of manifestations
- 1 x Active PIR motion/occupancy sensor (passive infrared)
- 1.5" Satin Silver Anodised Aluminum frame
- 4" high aluminum extrusion crown as standard

**Options**

	\$
Select the Weather Lighting	2509
Airflow unit 10,595-12,713 ft <sup>3</sup> /h	3194
Oak Fluted wall panels (per pod)	6671
Oak Smooth wall panels (per pod)	5801
Writeable glass (internal upgrade from acoustic)	380
Magnetic writeable glass (internal upgrade from acoustic)	1329
Powder coating	4060
Sliding ventilation beam	1046
Acoustic roof mat	1486
AV Upgrade 1	2324
AV Upgrade 2	2611
AV Upgrade 3	2431

SCENE PODS

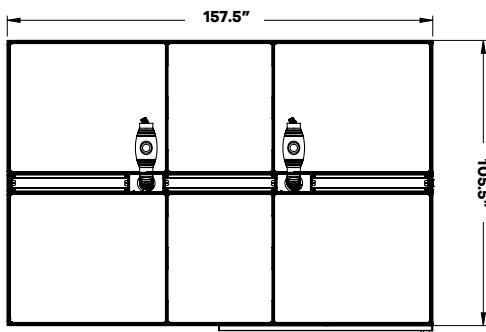

Acoustic performance is maximised when the pods are positioned on a carpeted surface, and when the acoustic roof mat is specified.

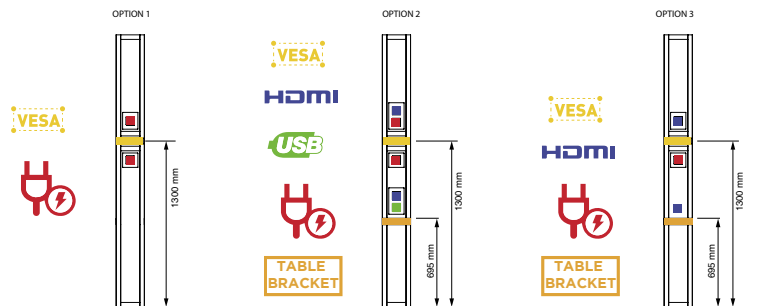



Model	Typical Occupancy	Frame Dimensions (H x W x D)	Price Grade 1 Fabric	Price Grade 2 Fabric	Price Grade 3 Fabric
SCENE 6		89.5 x 157.5 x 217"	88,574	90,426	91,370

**Standard Specification**

- Horizontal Beam Lighting
- Acoustic fully upholstered 217" (550.4") walls
- 0.25" (0.25") toughened frameless clear glass 118" (3000mm) walls featuring 2 levels of DDA compliant White line manifestations
- 3 x Power arches with 1 x CAT6 power & data panels (2 power 2 data)
- Acoustic ceiling panels upholstered in Camira Nexus Chalk
- 1 x 0.4" clear glass sliding door with soft open and close to include 2 levels of manifestations
- 1 x Active PIR motion/occupancy sensor (passive infrared)
- 1.5" Satin Silver Anodised Aluminum frame
- 4" high aluminum extrusion crown as standard

**Options**

Options	\$
Select the Weather Lighting	7287
Airflow unit 10,595-12,713 ft <sup>3</sup> /h	4796
Oak Fluted wall panels (per pod)	13,343
Oak Smooth wall panels (per pod)	11,602
Writeable glass (internal upgrade from acoustic)	380
Magnetic writeable glass (internal upgrade from acoustic)	1329
Powder coating	7435
Sliding ventilation beam	2087
Acoustic roof mat	3315
AV Upgrade 1	2324
AV Upgrade 2	2611
AV Upgrade 3	2431

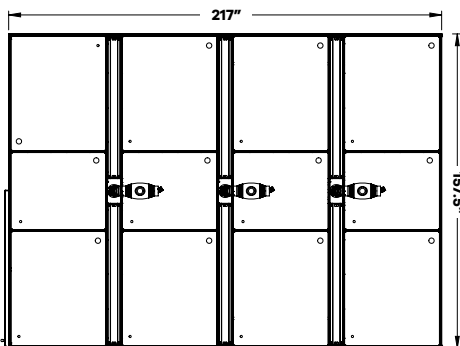

Acoustic performance is maximised when the pods are positioned on a carpeted surface, and when the acoustic roof mat is specified.

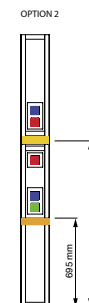
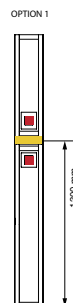





## Range Information



Occupancy: 1 to 10 people



Acoustic rated up to 34 dB  
(excluding Qube 180 & 360)



Delivery & Install **NOT** included

- PIR motion/occupancy sensor
- Soft open and close sliding glass door featuring DDA compliant 2" dia manifestations
- Acoustic ceiling panels upholstered in Camira Nexus Chalk
- 2" diameter DDA compliant circular manifestations on glass
- N.B. Acoustic performance is maximized when the pods are positioned on a carpeted surface and acoustic roof mat is selected.





Model	Typical Occupancy	Frame Dimensions (H x W x D)	Description		
			Price Band 1 Fabric	Price Band 2 Fabric	Price Band 3 Fabric
QUBE SOLO		87.5" x 56.75" x 43.5"	24,403	24,886	25,106

**Standard Specification**

- Fixed LED lighting built into ceiling
  - PIR motion/occupancy sensor
  - 2x 0.25" glazed panels featuring DDA compliant 2" dia manifestations
  - 1x 0.25" half glass panel
  - 1x half modesty panel
  - 2 x acoustic wall panels upholstered in Camira Lucia\*
  - 1 x hinged glass door
  - Acoustic ceiling panels upholstered in Camira Nexus Chalk
  - 2" diameter DDA compliant circular manifestations on glass
  - 1x fixed MFC shelf - 17" depth
  - 1.4" satin silver anodised aluminum frame
  - 2" crown
  - Standard height: 87.5"
- Overall pod height including airflow unit: 95.5" from finished floor level**

**Options**

	\$
Airflow Unit 5650 ft³/h	1250

PODS

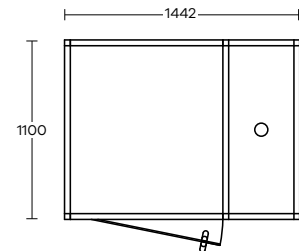

Acoustic performance is maximised when the pods are positioned on a carpeted surface, and when the acoustic roof mat is specified.



Model	Typical Occupancy	Frame Dimensions (H x W x D)	Price Band 1 Fabric	Price Band 2 Fabric	Price Band 3 Fabric
QUBE DUO	2	87.5" x 79" x 117.75"	37,134	37,690	38,227

**Standard Specification**

- Fixed LED lighting built into ceiling
  - PIR motion/occupancy sensor
  - 7 x 0.25" glass panels featuring DDA compliant 2" dia manifestations
  - 2 x fully upholstered acoustic wall panels
  - 1 x 0.4" soft open and close sliding glass door featuring DDA compliant 2" dia manifestations
  - Acoustic ceiling panels upholstered in Camira Nexus Chalk
  - 2" diameter DDA compliant circular manifestations on glass
  - 1.4" satin silver anodised aluminum frame
  - 2" crown
  - Standard height: 87.5"
- Overall pod height including airflow unit: 95.5" from finished floor level**

**Options**

	\$
Airflow unit 10,595-12,713 ft³/h	1597

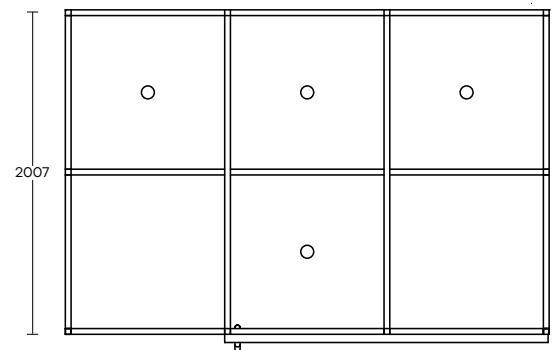

Acoustic performance is maximized when the pods are positioned on a carpeted surface, and when the acoustic roof mat is specified.

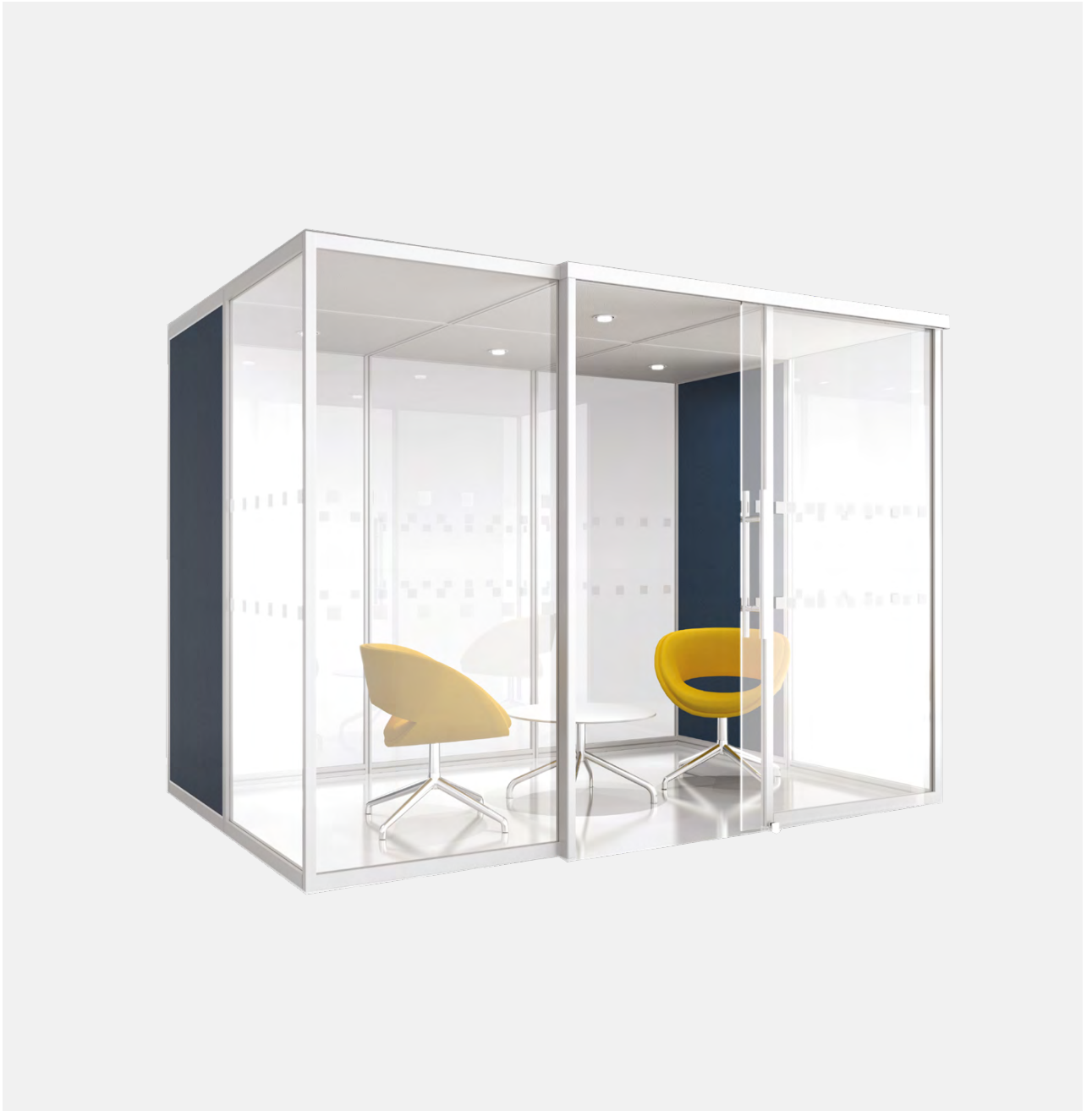

PODS





# Telephone Pods



boss

PODs



## Range Information

### At a Glance

-  Occupancy: 1 person
-  Delivery & Install NOT included



- 0.25" clear glass panel
- DDA compliant manifestations
- Fully upholstered acoustic wall panels
- 0.3" clear glass pivoting door
- 1.4" satin silver anodised aluminum frame as standard
- Floor fixed
- TP3 allows for vinyl graphics to be placed
- N.B. Acoustic performance is maximized when the pods are positioned on a carpeted surface and acoustic roof mat is selected.



Model	Typical Occupancy	Frame Dimensions (H x W x D)	Price Band 1 Fabric	Price Band 2 Fabric	Price Band 3 Fabric
TP1		87.5" x 35.5" x 35.5"	13,958	14,421	14,653

**Standard Specification**

- 1 x 0.25" clear glass panels with 2 levels of DDA compliant manifestations
- 2 x fully upholstered acoustic wall panels
- 1 x 0.3" clear glass pivoting door to include manifestations
- Latch handle
- Floor fixed
- 1.4" satin silver anodised aluminum frame
- 2" crown
- Standard height: 87.5"

**Note:**

Unit requires special floor fixing, unless levelling plinth is specified

**Options**

	\$
Concealed airflow	1810
LED down light	1306
Concealed Airflow + Quad strip LED downlighting	2787
Powder coated frame	718
Acoustic Roof Mat	275
Levelling plinth inc carpet	764

PODS

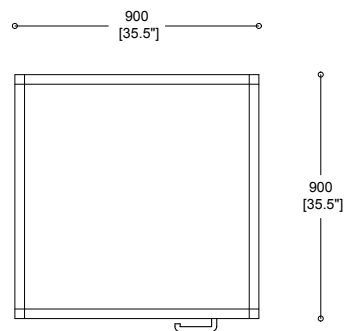

TP1

Acoustic performance is maximised when the pods are positioned on a carpeted surface, and when the acoustic roof mat is specified.



TP2 Pod

Model	Typical Occupancy	Frame Dimensions (H x W x D)	Price Band 1 Fabric	Price Band 2 Fabric	Price Band 3 Fabric
TP2	1	87.5" x 35.5" x 35.5"	15,403	15,750	15,926

**Standard Specification**

- 2 x 0.25" clear glass panels with 2 levels of DDA compliant manifestations
- 3 x fully upholstered acoustic wall panels
- 1 x 0.3" clear glass pivoting door to include manifestations
- 1 x fixed MFC shelf with bracket (35.5" high x 7.75" deep)
- Latch handle
- Floor fixed
- 1.4" satin silver anodised aluminum frame
- 2" crown
- Standard height: 87.5"

**Options**

	\$
Concealed airflow	1810
LED down light	1306
Concealed Airflow + Quad strip LED downlighting	2787
Powder coated frame	718
Acoustic Roof Mat	275
Levelling plinth inc carpet	764

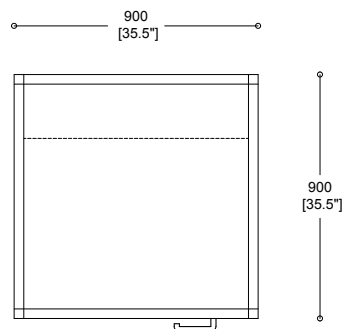

TP2

Acoustic performance is maximized when the pods are positioned on a carpeted surface, and when the acoustic roof mat is specified.



TP3 Pod

Model	Typical Occupancy	Frame Dimensions (H x W x D)	Price Band 1 Fabric	Price Band 2 Fabric	Price Band 3 Fabric
TP3		87.5" x 35.5" x 35.5"	15,292	15,755	15,991

Price does not include packaging. Delivery and/or installation is an additional charge

**Standard Specification**

- 1 x 0.25" clear glass panel with 2 levels of DDA compliant manifestations
- 2 x Upholstered acoustic inner panels
- 1 x 0.3" clear glass pivoting door to include manifestations
- 1 x corner MFC shelf with bracket (32.5" high)
- Latch handle
- Floor fixed
- 1.4" satin silver anodised aluminum frame
- 2" crown
- Standard height: 87.5"

**Options**

	\$
Concealed airflow	1810
LED down light	1306
Concealed Airflow + Quad strip LED downlighting	2787
Powder coated frame	718
Acoustic Roof Mat	275
Levelling plinth inc carpet	764
Acoustic inner panels with printed red telephone graphics (including solid outer panels with matching printed red telephone graphic)	2778

PODS

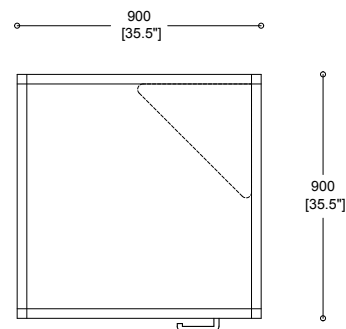

TP3

Acoustic performance is maximised when the pods are positioned on a carpeted surface, and when the acoustic roof mat is specified.



Model	Frame Dimensions (H x W x D)	Description	Price Band 1 Fabric	Price Band 2 Fabric	Price Band 3 Fabric
TP4	W40.25" x D37.5" x H80.5"	Fluted Oak	25,018	25,250	25,319
TP4	W40.25" x D37.5" x H80.5"	Oak Relief	24,722	24,954	25,023

**Standard Specification**

- Satin silver anodised frame
- Levelling plinth, including carpet (Interface Heuga 725 Elephant 672505)
- LED downlight, PIR operated
- Brush Seal to door
- 0.3" toughened glass pivoting door, with latch handle
- 0.25" twin glass rear panels
- 2x Acoustic internal panels, upholstered
- Power supply cable exits under clad panels, 197" cable supplied

**Options**

Exterior Occupancy Indicator - 1x Sides	699
---	-----

**Options - Rear Acoustic Panel Upgrade**

Rear Acoustic Panels - Band 1	755
Rear Acoustic Panels - Band 2	986
Rear Acoustic Panels - Band 3	1106

**Frame Handle Finish**

Satin Silver Anodised	included
-----------------------	----------

**Options - Lighting & Airflow**

LED Single Downlight Only	included
Quad Strip LED lighting, concealed Airflow	2148

**Options - Workshelf & Power/Charging**

8" Deep workshelf	1449
11" Deep workshelf	2028
Phase unit, 1x power, 2x USB Charging (A+C)	931

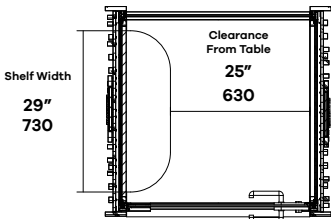

Acoustic performance is maximized when the pods are positioned on a carpeted surface, and when the acoustic roof mat is specified.



Standard Configuration with Glass Rear



Acoustic Rear Panel Upgrade

**External Pod finishes**

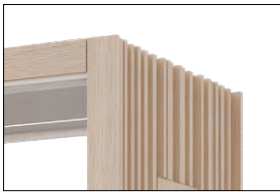

Oak Relief



Fluted Oak

**Frame and Handle Finishes**



White RAL 9003



Black RAL 9005



Anthracite RAL 7016



Satin Silver

**Lighting Options**



LED Down Light



Quad Strip LED Lighting

**Additional Options**



Shelf  
Depth: 200mm or 28197"m



Door Handle Lock



Changing Occupancy Indicator



USA  
Power & USB charge



**10.**

**Cartwright**

# 20/123 Series

The 123 Series is a classic, elegant and timeless design. It incorporates a stainless-steel frame with pleasant aesthetics from all angles.



## Range Information

- Exposed frame: stainless steel
- SS: Super Satin finish.
- Upholstery frame: plywood
- Loose Seat cushion: multi-density polyurethane
- Loose Back cushion: high density polydacron
- Loose Arm cushion; high density polydacron

**20/123  
ARM CHAIR**

Code:	Description	COM	2	3	4	5	6	7	8	9	10	COL	L1	L2	L3	(ly)	(ft²)	(lb)
		/1																



**20/123 MP**

Arm Chair,  
Loose  
Cushion

4306 4426 4570 4666 4834 4954 5168 5406 5716 6002 4472 5806 6622 9116 4.75 86 75

**20/124**

Code:	Description	COM	2	3	4	5	6	7	8	9	10	COL	L1	L2	L3	(ly)	(ft²)	(lb)
		/1																



**20/124-58 MP**

Settee,  
Loose  
Cushion

5700 5870 6074 6210 6448 6618 6922 7260 7700 8106 5930 7822 8980 12518 6.75 122 115



**20/124-80 MP**

Sofa,  
Loose  
Cushion

7006 7226 7490 7666 7974 8194 8588 9026 9596 10122 7300 9750 11250 15832 8.75 158 155

**OPTIONS**

- Multi-fabric application



**TO ORDER**

- 1 Specify Item Number
- 2 Specify Frame Finish  
SS ..... STANDARD
- 3 Specify Upholstery Name,  
Color Number And Name
- 4 Specify Options

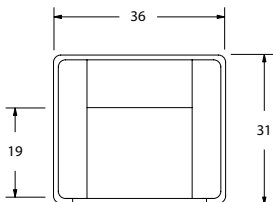

20/123

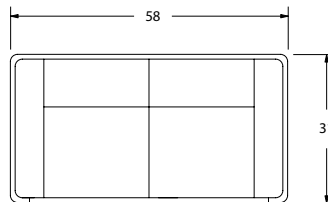

20/124-58

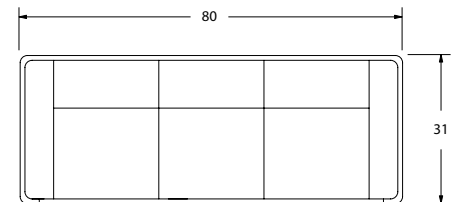

20/124-80

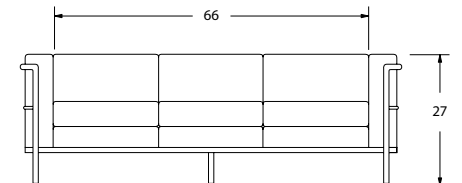
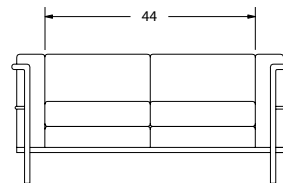
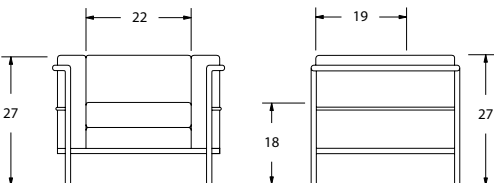

# 180 Series

The 180 Series is a modular versatile chair and sofa set. The pieces can be mixed and matched and are suitable for any size environment.



## Range Information

- Upholstery frame: reinforced hardwood and plywood
- Loose Seat/Loose Back cushions: multi-density polyurethane
- Exposed Leg selection:
  - PB: Black, high impact plastic, non-skid bottom pad. Standard.
  - PC: Chrome finish, high impact plastic, non-skid bottom pad. Upcharge.
  - BA: Brushed aluminum cylindrical leg, with black plastic glide. Upcharge.
  - HW: Solid Hardwood square leg, with glide.
- Finish must be specified. Subject to upcharge.
- Modular units shipped with ganging straps
- Note: Up to three modules may be ordered permanently pre-assembled. Specify left to right facing
- Floor plan must accompany order for modules

180 SERIES	Code:	Description	COM /1	2	3	4	5	6	7	8	9	10	COL	L1	L2	L3	(ly)	(ft²)	(lb)
	<b>20/180 PB</b>	Arm Chair	1968	2118	2298	2418	2628	2778	3048	3348	3738	4098	2140	3814	4840	7972	6.00	108	-
	<b>20/181-60 PB</b>	Settee	3120	3414	3768	4004	4416	4710	5240	5828	6592	7298	3450	6736	8750	14898	11.75	212	-
	<b>20/181-87 PB</b>	Sofa	4108	4422	4798	5048	5486	5800	6364	6990	7804	8554	4468	7956	10094	16618	12.50	225	-
	<b>20/182 PB</b>	Armless Module	1628	1766	1932	2042	2236	2374	2622	2898	3256	3586	1784	3320	4260	7130	5.50	99	-
	<b>20/183R PB</b>	Raf Module	1682	1826	2000	2116	2318	2462	2722	3010	3384	3730	1846	3458	4446	7462	5.75	104	-
	<b>20/183L PB</b>	Laf Module	1682	1826	2000	2116	2318	2462	2722	3010	3384	3730	1846	3458	4446	7462	5.75	104	-
	<b>20/184 PB</b>	Corner Module	2032	2190	2378	2504	2724	2882	3164	3478	3886	4262	2212	3964	5038	8314	6.25	113	-
	<b>20/185 PB</b>	Ottoman	924	994	1078	1134	1232	1302	1426	1564	1744	1910	1004	1780	2254	3704	2.75	50	-

**OPTIONS**

- Contrasting welt
- Multi-fabric application

**TO ORDER**

- 1 Specify Item Number
- 2 Specify Leg Selection  
 PB ..... STANDARD  
 PC ..... \$ 68.00 LIST  
 BA ..... \$ 94.00 LIST  
 HW ..... \$ 62.00 LIST
- 3 Specify Hardwood Leg Finish, If Applicable
- 4 Specify Upholstery Name, Color Number And Name
- 5 Specify Options
- 6 Include Floor Plan

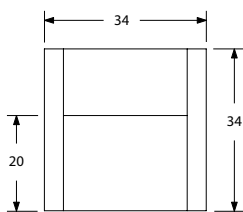

20/180

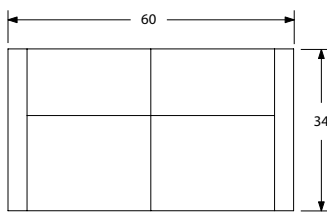

20/181-60

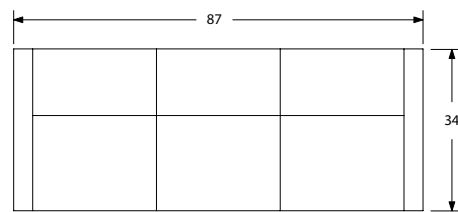

20/181-87

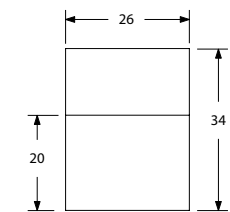
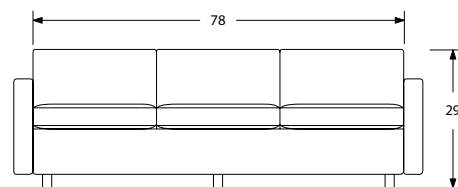
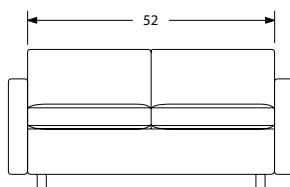
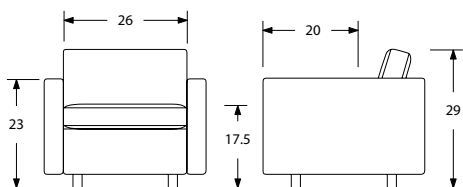

20/182

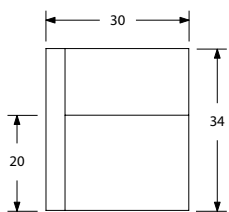

20/183L

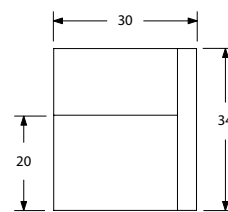

20/183R

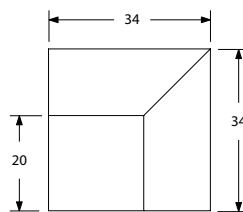
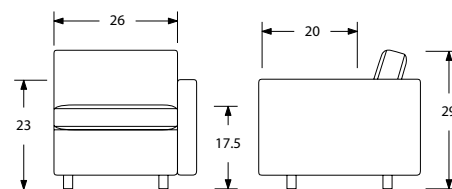
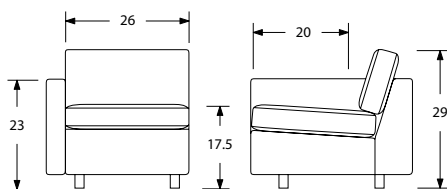
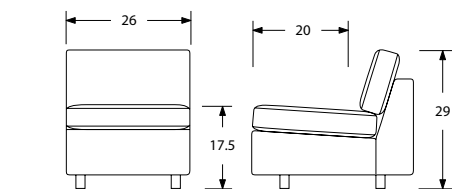

20/184

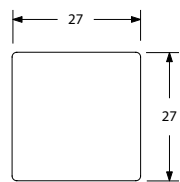

20/185

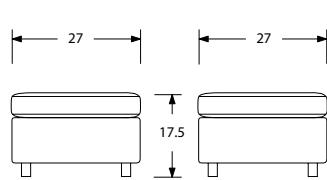
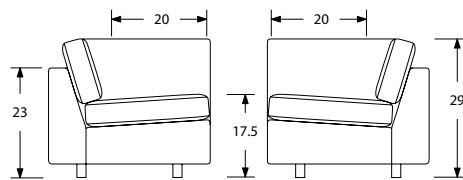





This inviting chair has a curved back to maximize comfort with a 360-degree swivel on a wood plinth base. Aldo is great for small gatherings and seating areas. The loose seat cushion and curves also add superior comfort.



## Range Information

- Upholstery frame: reinforced hardwood and plywood
- Loose Seat cushion: multi-density polyurethane
- Tight Back: high density polyurethane
- Exposed base: solid hardwood. Finish must be specified.
- See Wood Finishes section.
- Arm chair standard with 360° swivel base.
- Non-swivel base available.



**20/123  
ARM CHAIR**

**Code:** Description **COM** **2** **3** **4** **5** **6** **7** **8** **9** **10** **COL** **L1** **L2** **L3**     
/1 (ly) (ft²) (lb)



**20/210** Armchair 2954 4980 7410 9030 11866 13892 17538 21588 26854 31714 5030 6364 7180 9674 81 86 75

**20/124**

**Code:** Description **COM** **2** **3** **4** **5** **6** **7** **8** **9** **10** **COL** **L1** **L2** **L3**     
/1 (ly) (ft²) (lb)



**20/211-56** Settee 3432 3608 3818 3958 4204 4380 4696 5046 5502 5922 3646 5600 6796 10450 7.00 126 115



**20/211-80** Sofa 4208 4446 4732 4922 5256 5494 5922 6398 7016 7586 4492 7144 8768 13726 9.50 171 155

**OPTIONS**

- Arm Chair with non-swivel base.
- Contrasting welt
- Multi-fabric application
- Custom matched wood finish.
- See Wood Finishes section.

**TO ORDER**

- 1 Specify Item Number
- 2 Specify Finish Number
- 3 Specify Upholstery Name, Color Number And Name
- 4 Specify Options

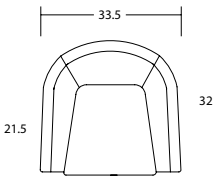

20/210  
20/210

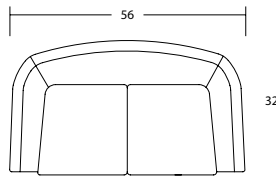

20/211-56  
20/211-56

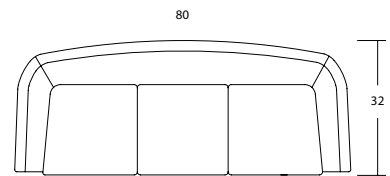

20/211-80  
20/211-80

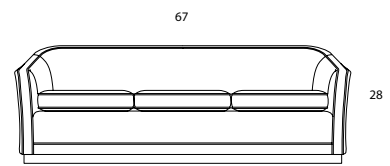
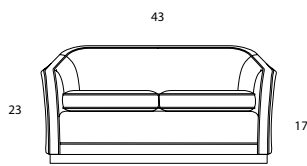
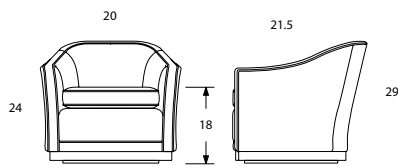

# Buff





The Buff chair features a stainless-steel frame with a satin finish and welded joints for enhanced stability and longevity.

Buff is perfect for a wide variety of uses and the chosen textile will instantly transform the look of the chair to complement its surroundings.



## Range Information

- Exposed frame: 16 gauge, ½" x 1 ½" flat tubular stainless steel, Super Satin (SS) finish, black plastic glides.
- Upholstery frame: solid hardwood
- Seat/Back: upholstered, polyurethane
- Arm Caps:
  - NC: No arm cap. Standard
  - WC: Solid hardwood, Finish must be specified; adds 1/2" to arm height. See Wood Finishes. Upcharge
  - UC: Black, urethane, steel reinforced; adds 1/2" to arm height. Upcharge
- Clean out between seat and back

BUFF	Code:	Description	COM	2	3	4	5	6	7	8	9	10	COL	L1	L2	L3			
			/1												(ly)	(ft²)	(lb)		
	<b>30/703 NC</b>	Arm Chair	1852	1890	1936	1966	2020	2058	2126	2202	2300	2390	1910	2330	2586	3368	1.50	27	-
	<b>30/704-40 NC</b>	Bariatric Arm Chair	2118	2176	2244	2290	2370	2428	2530	2644	2792	2928	2198	2834	3224	4412	2.25	41	-
	<b>30/705 NC</b>	High Back Patient Chair	2110	2154	2208	2244	2306	2350	2430	2518	2632	2738	2176	2672	2976	3904	1.75	32	
	<b>30/706-40 NC</b>	High Back Bariatric Chair	2236	2306	2390	2446	2544	2614	2738	2876	3056	3222	2330	3106	3580	5030	2.75	50	
	<b>30/708 NC</b>	Hip Chair	2080	2118	2164	2194	2248	2286	2354	2430	2528	2618	2140	2560	2816	3598	1.50	27	

**OPTIONS**

- Multi-fabric application
- Custom matched wood finish.
- See Wood Finishes section.

**TO ORDER**

- 1 Specify Item Number
- 2 Specify Arm Cap Selection  
 NC ..... STANDARD  
 WC ..... \$ 62.00 LIST  
 UC ..... \$ 84.00 LIST
- 3 Specify Finish Number, If Applicable
- 4 Specify Upholstery Name,  
 Color Number And Name
- 5 Specify Options

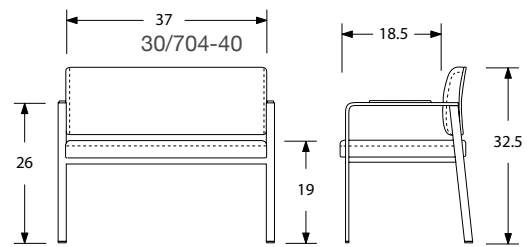
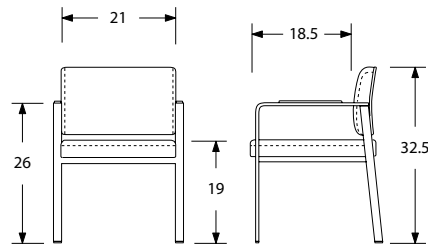
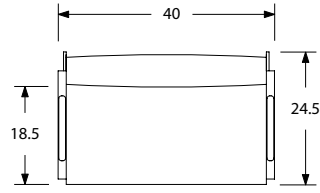
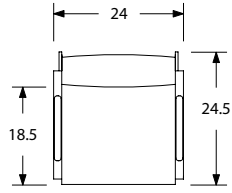

30/703

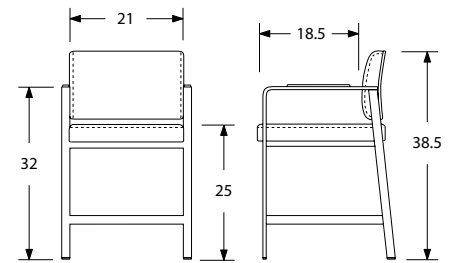
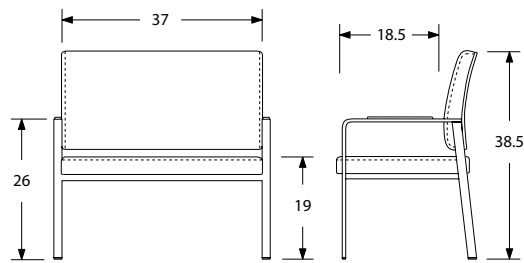
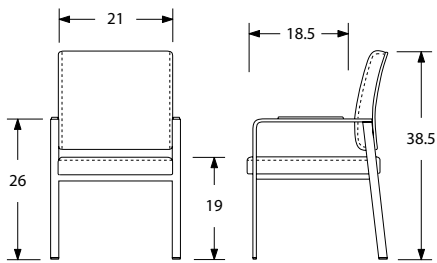
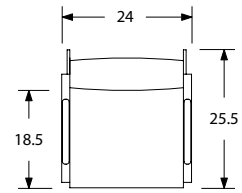
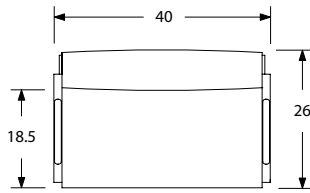
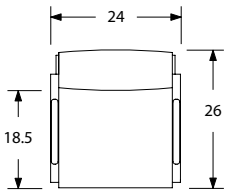

30/705

30/706-40

30/708



# Clancy

This classic design features a tight back & loose cushion seating for comfort. Clancy comes with a stainless steel satin finish as well as wood base color options.

The choice of textile allows the design to transition into any environment.



## Range Information

- Upholstery frame: reinforced hardwood and plywood
- Loose Seat cushion: multi-density polyurethane
- Tight Back: polydacron
- 7/8" square legs, 1 1/2" x 1/2" flat tubular rails, 16 gauge stainless steel, black plastic glides.
- SS: Super Satin finish. Standard
- W: Wood Base, solid hardwood. Finish must be specified.
- See Wood Finishes section. Upcharge.

CLANCY	Code:	Description	COM /1	2	3	4	5	6	7	8	9	10	COL	L1	L2	L3	(ly)	(ft²)	(lb)
	<b>21/140 MP</b>	Arm Chair	2184	2284	2404	2484	2624	2724	2904	3104	3364	3604	2308	3424	4108	6196	4.00	72	-
	<b>21/141-58 MP</b>	Settee	3440	3628	3854	4004	4268	4456	4794	5170	5658	6108	3666	5760	7042	10956	7.50	135	-
	<b>21/141-80 MP</b>	Sofa	3902	4116	4372	4542	4840	5054	5438	5864	6418	6928	4158	6530	7984	12420	8.50	153	-
	<b>21/142 MP</b>	High Back Arm Chair (shown with Ottoman)	2390	2498	2626	2712	2862	2970	3162	3376	3654	3910	2524	3718	4450	6682	4.25	77	-
	<b>21/143/MP</b>	Ottoman	1722	1804	1902	1968	2082	2164	2312	2476	2688	2884	1824	2740	3300	5010	3.25	59	-

**OPTIONS**

- Contrasting welt
- Multi-fabric application
- Custom matched wood finish.
- See Wood Finishes section.

**TO ORDER**

- 1 Specify Item Number
- 2 Specify Base Selection  
SS ..... STANDARD  
W ..... UPCHARGE  
ARM CHAIR ..... \$ 38.00 LIST  
HIGH BACK ARM CHAIR ..... \$ 38.00 LIST  
SETTEE ..... \$ 62.00 LIST  
SOFA ..... \$ 88.00 LIST  
OTTOMAN ..... \$ 38.00 LIST
- 3 Specify Finish Number, If Applicable
- 4 Specify Upholstery Name,  
Color Number And Name
- 5 Specify Options

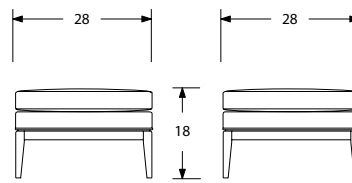
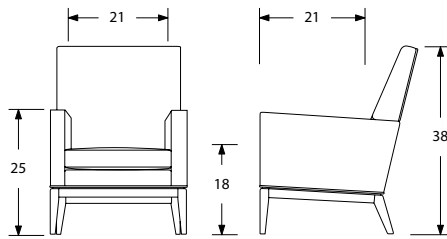
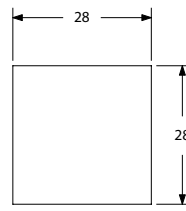
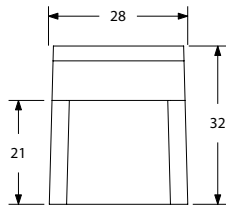

21/142

21/143

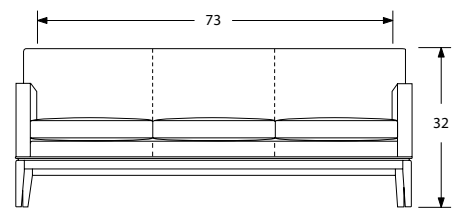
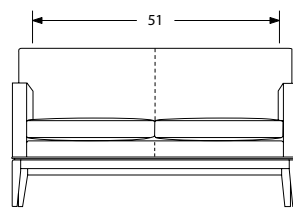
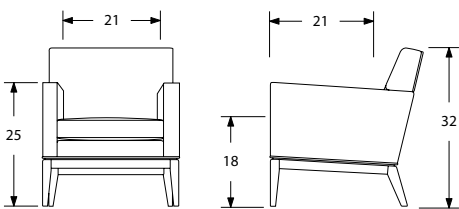
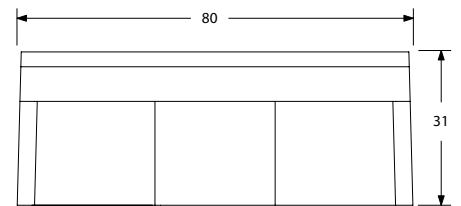
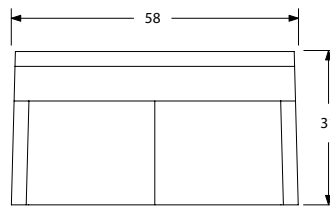
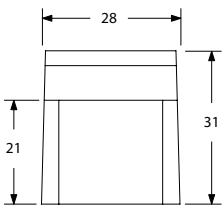

21/140

21/141-58

21/141-80



# Greg

Executive seating or conference chair. The slim design incorporates lumbar support built into the frame and roll-off seat edge to enhance comfort. Polished aluminum arms protect surfaces via the urethane pad.

Offered in both high and mid-back configurations.



## Range Information

- Upholstery frame: molded plywood
- Seat/Back: high density polydacron
- Arms:
- UR: molded, semi-rigid black urethane, steel reinforced. Standard.
- AL: cast, polished aluminum with molded semi-rigid black urethane arm pad inset. Upcharge
- Base:
- 2 base styles and 2 control mechanisms offered.
- See Executive Base and Control Options section for complete descriptions.
- Casters: black, 2 3/16" diameter, dual wheel
- Gas lift standard



**10/855 UR  
BP6**

Mid Back Tilt  
Swivel

1132 1176 1230 1266 1328 1372 1452 1540 1654 1760 1188 1684 1988 2916 1.75 32 -



**10/857 UR  
BP6**

High Back Tilt  
Swivel

1266 1316 1376 1416 1486 1536 1626 1726 1856 1976 1330 1888 2230 3274 2.00 36 -

**OPTIONS**

- Contrasting welt
- Multi-fabric application
- Custom matched wood finish.
- See Wood Finishes section.

**TO ORDER**

- 1 Specify Item Number
- 2 Specify Arm Selection  
UR ..... Standard  
AL ..... \$ 124.00 List
- 3 Specify Base Selection  
BP ..... Standard  
MN ..... \$ 100.00 List  
#7 Knee Tilt ..... \$ 30.00 List
- 5 Specify Base Finish Number, If Applicable
- 6 Specify Upholstery Name,  
Color Number And Name
- 7 Specify Options

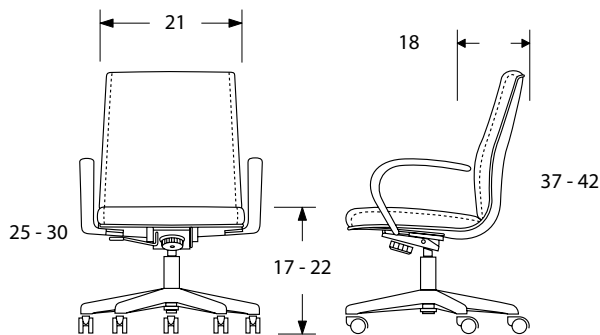
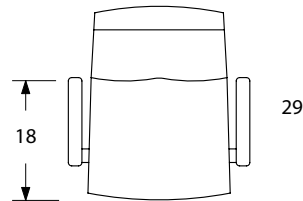
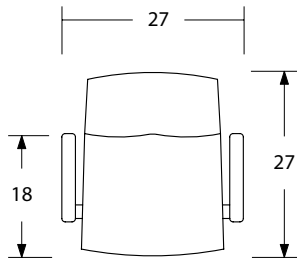

10/855

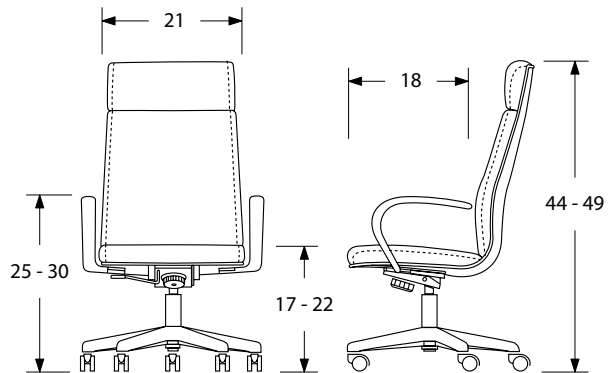

10/857

# Kelly

Kelly's tight cushions provide comfort for the mind and body. The unique stainless steel leg frame gives an artistic look to any room.

Available in arm or armless options; either way, the comfort is immaculate.



## Range Information

- Upholstery frame: reinforced hardwood and plywood
- Tight Seat/Tight Back: polydacron
- Exposed base:
  - 1 1/2" x 1/2" flat tubular 16 gauge stainless steel, black plastic glides. Standard.
  - SS: Super Satin finish on base

**KELLY**

Code:	Description	COM /1	2	3	4	5	6	7	8	9	10	COL	L1	L2	L3	(ly)	(ft²)	(lb)
-------	-------------	-----------	---	---	---	---	---	---	---	---	----	-----	----	----	----	------	-------	------



**20/960  
MP**

Armless Chair 1950 2008 2076 2122 2202 2260 2362 2476 2624 2760 2030 2666 3056 4244 2.25 41 -



**20/961-48  
MP**

Armless Settee 2966 3060 3174 3250 3382 3476 3646 3834 4078 4304 3092 4146 4792 6764 3.75 68 -



**20/961-72  
MP**

Armless Sofa 3972 4110 4276 4386 4580 4718 4966 5242 5600 5930 4152 5688 6628 9498 5.50 99



**20/965 MP**

Arm Chair 2378 2466 2572 2642 2766 2854 3012 3188 3416 3626 2492 3470 4068 5894 3.50 63



**20/966-54  
MP**

Settee 3386 3518 3676 3782 3966 4098 4336 4600 4942 5258 3554 5028 5930 8684 5.25 95



**20/966-78  
MP**

Sofa 4762 4932 5136 5272 5510 5680 5984 6322 6762 7168 4982 6874 8032 11570 6.75 122

**OPTIONS**

- Contrasting welt
- Multi-fabric application

**TO ORDER**

- 1 Specify Item Number
- 2 Specify Base Selection  
SS ..... STANDARD
- 3 Specify Upholstery
- 4 Specify Options

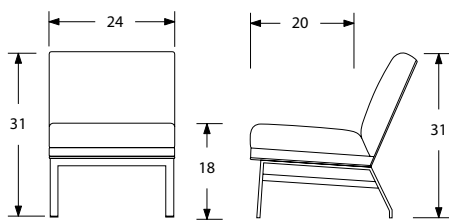
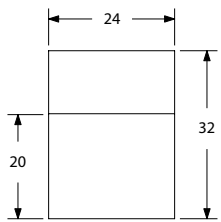

20/960

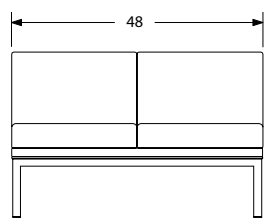
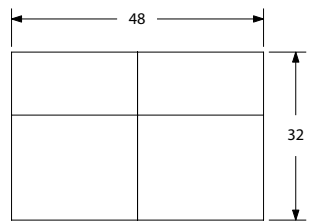

20/961-48

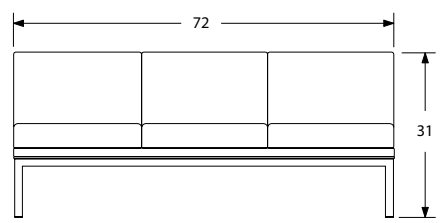
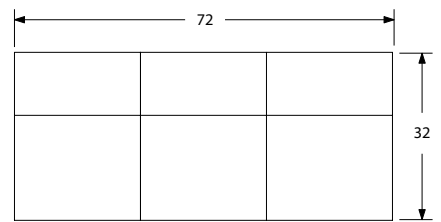

20/961-72

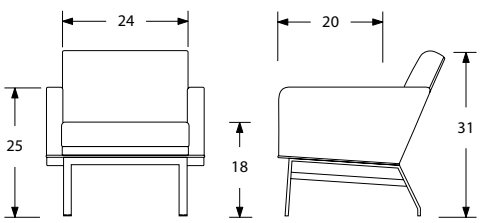
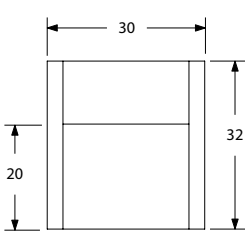

20/965

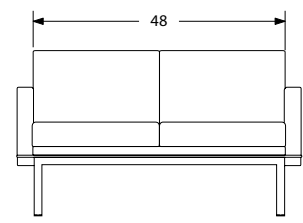
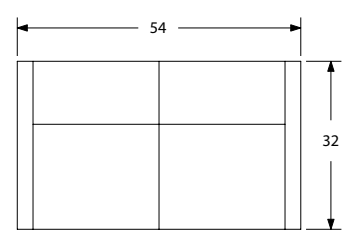

20/966-54

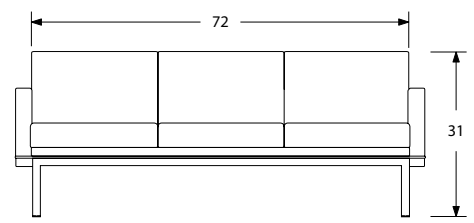
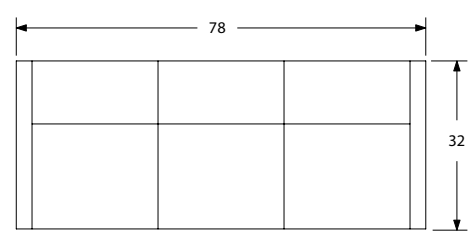

20/966-78



# Logan

Sophisticated or Casual. Logan can easily create visual appealing décor, casual or chic, depending on the upholstery selection.

Logan features a stainless-steel base and loose seat and back cushions.



## Range Information

- Upholstery frame: reinforced hardwood and plywood
- Loose Seat/Loose Back cushions: high-density polyurethane
- Exposed base:  
1" x 1" square, 16 gauge tubular stainless steel, black plastic glides. Standard.
- SS: Super Satin finish

**LOGAN**

**Code:**

**Description**

**COM**  
**/1**

**2**

**3**

**4**

**5**

**6**

**7**

**8**

**9**

**10**

**COL**

**L1**

**L2**

**L3**

  
**(ly)**

  
**(ft²)**

  
**(lb)**



**21/340 MP**

Arm Chair

2242 2368 2518 2618 2794 2920 3146 3396 3722 4022 2392 3788 4642 7252 5.00 90 -



**21/341-56 MP**

Settee

3518 3706 3932 4082 4346 4534 4872 5248 5736 6186 3744 5838 7120 11034 7.50 135 -



**21/341-80 MP**

Sofa

4804 5048 5342 5538 5880 6124 6564 7052 7686 8272 5100 7828 9500 14604 9.75 176

**OPTIONS**

- Multi-fabric application
- Super Satin (SS) base finish.

**TO ORDER**

- 1 Specify Item Number
- 2 Specify Base Selection  
SS ..... STANDARD
- 3 Specify Upholstery Name,  
Color Number And Name
- 4 Specify Options

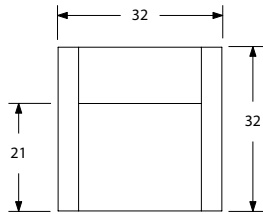

21/340

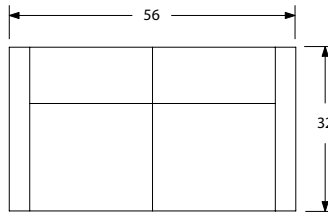

21/341-56

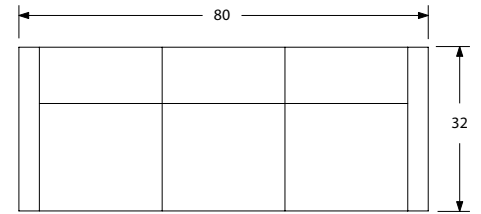

21/341-80

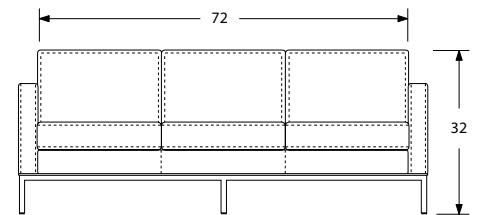
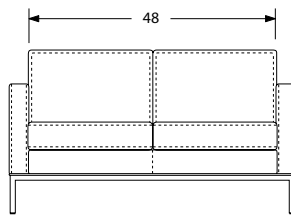
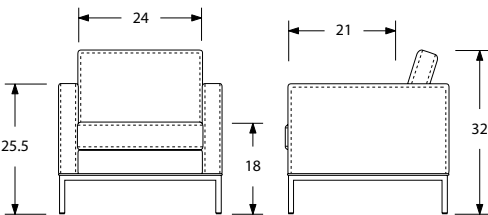

# Maestro

A versatile and appealing solution for small or large seating areas. The unique modular components can create a chair with arms or a winding section to seat a few people or larger groups.



## Range Information

- Frame: reinforced hardwood and plywood
- Tight Seat/Tight Back: polydacron
- Exposed Leg selection:
  - PB: Black, high impact plastic, non-skid bottom pad. Standard.
  - PC: Chrome finish, high impact plastic, non-skid bottom pad. Upcharge.
- BA: Brushed aluminum cylindrical leg, with black plastic glide. Upcharge.
- HW: Solid Hardwood square leg with glide.
- Finish must be specified. See Wood Finishes. Upcharge.
- CC: Casters front and rear. Black, 2 3/16" diameter, dual wheel. Upcharge.
- T: Tablet or TC: Tablet with cup holder, offered on styles 21/226, 21/227 and 21/228. See Modular Lounge Construction Options.
- Ganging: each unit shipped with 2 ganging straps
- Floor plan must accompany order

**MAESTRO**

**Code:**

**Description**

**COM**  
**/1**

**2**

**3**

**4**

**5**

**6**

**7**

**8**

**9**

**10**

**COL**

**L1**

**L2**

**L3**



**20/990 PB**

Armless  
Module

1078 1142 1218 1268 1356 1420 1534 1660 1824 1974 1154 1852 2280 3584 2.50 45 -



**20/991 PB**

RAF Corner  
Module

1390 1478 1584 1654 1778 1866 2024 2200 2428 2638 1494 2472 3070 4896 3.50 63 -

Image coming soon

**20/992 PB**

LAF Corner  
Module

1390 1478 1584 1654 1778 1866 2024 2200 2428 2638 1494 2472 3070 4896 3.50 63



**20/993 PB**

Outside  
Corner Module

1280 1338 1406 1452 1532 1590 1692 1806 1954 2090 1352 1988 2378 3566 2.25 41

**OPTIONS**

- Multi-fabric application
- Super Satin (SS) base finish.

**TO ORDER**

- 1 Specify Item Number
- 2 Specify Leg Selection  
Pb ..... Standard  
Pc ..... \$ 68.00 List  
Ba ..... \$ 94.00 List  
Hw ..... \$ 62.00 List  
Cc ..... \$ 30.00 List
- 3 Specify Hardwood Leg Finish  
If Applicable

- 4 Specify Tablet Option, If Applicable  
T ..... \$ 344.00 List  
Tc ..... \$ 350.00 List
- 5 Specify Tablet Color, If Applicable  
M ..... Light Maple  
C ..... Amber Cherry  
B ..... Black Laminate
- 6 Specify Upholstery Name,  
Color Number And Name
- 7 Specify Options
- 8 Include Floor Plan

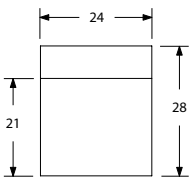

20/990

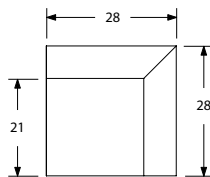

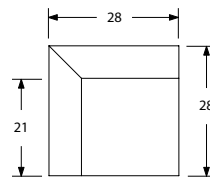

20/991

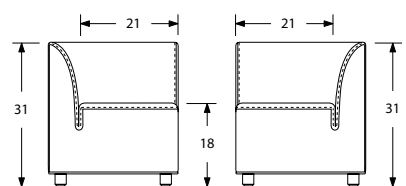
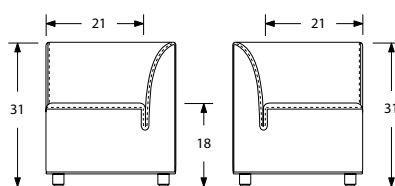
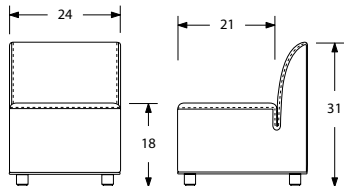

20/992



MAESTRO

	Code:	Description	COM /1	2	3	4	5	6	7	8	9	10	COL	L1	L2	L3	(ly)	(ft²)	(lb)
Image coming soon	<b>20/226 PB</b>	RAF Module	1790	1884	1998	2074	2206	2300	2470	2658	2902	3128	1904	2958	3604	5576	3.75	68	-
	<b>20/227 PB</b>	LAF Module	1790	1884	1998	2074	2206	2300	2470	2658	2902	3128	1904	2958	3604	5576	3.75	68	-
	<b>20/228 PB</b>	Module with Arms	2016	2142	2292	2392	2568	2694	2920	3170	3496	3796	2164	3560	4414	7024	5.00	90	-
	<b>20/229 PB</b>	Cube 24x24x18	726	764	810	840	894	932	1000	1076	1174	1264	772	1192	1448	2230	1.50	27	-
	<b>20/233 PB</b>	Tall Cube 24x24x24	918	976	1044	1090	1170	1228	1330	1444	1592	1728	986	1622	2012	3200	2.25	41	-
	<b>20/234 PB</b>	Rectangular Cube 24x28x18	794	838	892	928	990	1034	1114	1202	1316	1422	848	1344	1648	2576	1.75	32	-
Image coming soon	<b>20/238 PB</b>	Rectangular Cube 28x24x18	794	838	892	928	990	1034	1114	1202	1316	1422	848	1344	1648	2576	1.75	32	-
	<b>20/242 PB</b>	Tall Rectangular Cube 24x28x24	966	1030	1106	1156	1244	1308	1422	1548	1712	1862	1042	1740	2168	3472	2.50	45	-
	<b>20/243 PB</b>	Quarter Round 28x28x18	930	980	1040	1080	1150	1200	1290	1390	1520	1640	990	1548	1890	2934	2.00	36	-

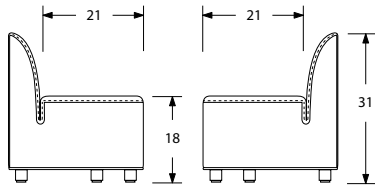
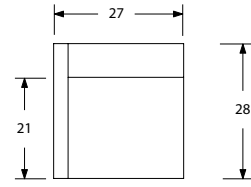
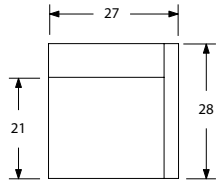
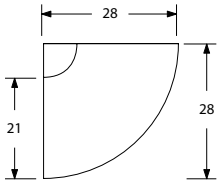

20/993

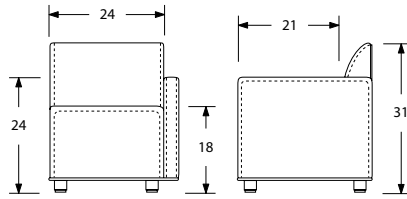

21/226

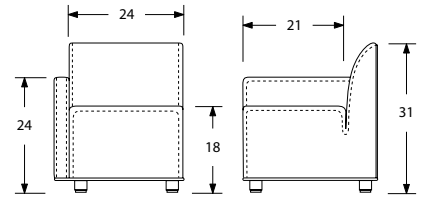

21/227

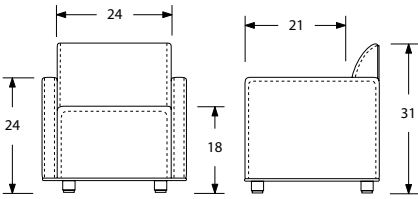
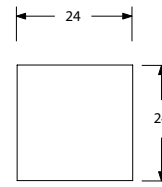
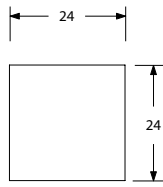
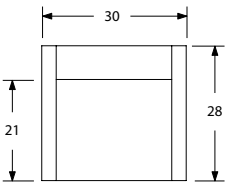

21/228

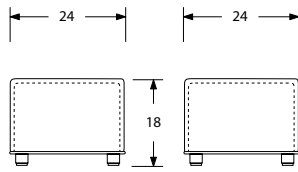

21/229

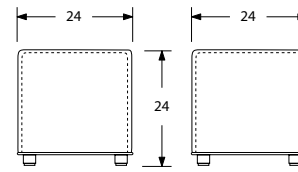

21/233

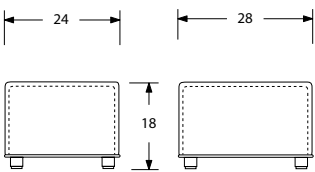
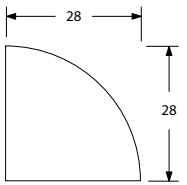
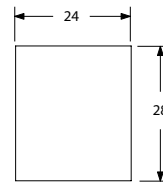
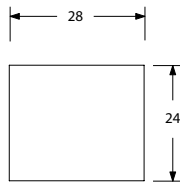
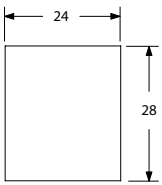

21/234

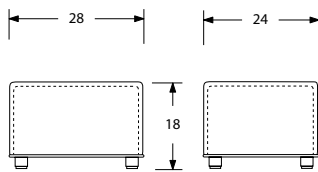

21/238

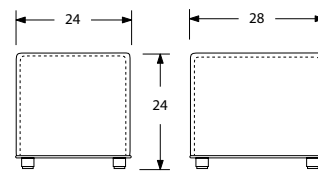

21/242

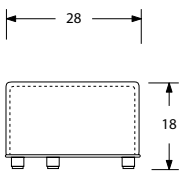

21/243

# O'Brien





Loose or tight seat cushion option, tight back cushion and variety leg materials and shapes (including casters) allow this series to be designed for many needs.

Wood arms are available as can be crafted with a rotating tablet.

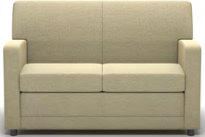

## Range Information

- Upholstery frame: reinforced hardwood and plywood
- Loose Seat cushion: multi-density polyurethane
- Tight Seat: polydacron
- Tight Back: high density polydacron
- Leg Selections:
  - LL HWR: Round solid hardwood legs. Finish must be specified. Standard.
  - LL HWSQ: Square, solid hardwood legs. Finish must be specified. Upcharge
  - LL BAL: Cylindrical, brushed aluminum legs. Upcharge.
  - LC: Legs front, Casters rear. Upcharge.
  - CC: Black, 3" dual wheel casters. Upcharge.
  - Arm Cap Option:
    - WC: solid hardwood arm cap. Upcharge. Finish must be specified.
    - Standard Tablet: 15" diameter, self-edged, high pressure laminate, 360° offset rotation. See Lounge/Modular
- Options
  - section for more complete description
  - T: Tablet. Upcharge.
  - TC: Tablet with cup holder. Upcharge.
  - Tablet, high pressure laminate, color options:
    - M: Light Maple color and grain
    - C: Amber Cherry color and grain.
    - B: Black high pressure laminate.
  - NOTE: Tablet options only offered on 20/900 and 20/905 Arm Chairs.

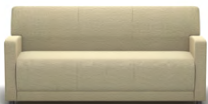
O'BRIEN	Code:	Description	COM /1	2	3	4	5	6	7	8	9	10	COL	L1	L2	L3	(ly)	(ft²)	(lb)
	<b>20/900 LL</b>	Arm Chair Loose Cushion/Tight Back	2064	2196	2354	2460	2644	2776	3014	3278	3620	3936	2218	3692	4594	7348	5.25	95	-
	<b>20/903-52 LL</b>	Settee Loose Cushion/Tight Back	2804	2986	3204	3350	3604	3786	4114	4478	4950	5386	3016	5048	6292	10090	7.25	131	-
	<b>20/903-74 LL</b>	Sofa Loose Cushion/Tight Back	3460	3692	3970	4156	4480	4712	5130	5594	6196	6752	3730	6320	7906	12748	9.25	167	-
	<b>20/905 LL</b>	Arm Chair Tight Cushion/ Tight Back	2028	2160	2318	2424	2608	2740	2978	3242	3584	3900	2182	3656	4558	7312	5.25	95	-
	<b>20/908-52 LL</b>	Settee Tight Cushion/Tight Back	2752	2928	3138	3278	3524	3700	4016	4366	4822	5242	2958	4912	6108	9762	7.00	126	-
	<b>20/908-74 LL</b>	Sofa Tight Cushion/Tight Back	3392	3612	3876	4052	4360	4580	4974	5412	5982	6508	3650	6100	7600	12182	8.75	158	-

### OPTIONS

- Contrasting welt
- Multi-fabric application
- Custom matched wood finish.  
See Wood Finishes section.

### TO ORDER

- Specify Item Number
- Specify Leg Selection
  - LL HWR ..... STANDARD
  - LL HWSQ ..... \$ 30.00 LIST
  - LL BAL ..... \$ 55.00 LIST
  - LC HWR ..... \$ 38.00 LIST
  - LC HWSQ ..... \$ 62.00 LIST
  - LC BAL ..... \$ 88.00 LIST
  - CC ..... \$ 30.00 LIST
- Specify Arm Cap Option, If Applicable
  - WC ..... \$412.00 LIST

- Specify Leg/Arm Cap Finish  
Number, If Applicable
- Specify Tablet Option, If Applicable
  - T ..... \$ 344.00 LIST
  - TC ..... \$ 350.00 LIST
- Specify Tablet Color, If Applicable
  - M ..... LIGHT MAPLE
  - C ..... AMBER CHERRY
  - B ..... BLACK LAMINATE
- Specify Upholstery Name,  
Color Number And Name
- Specify Options

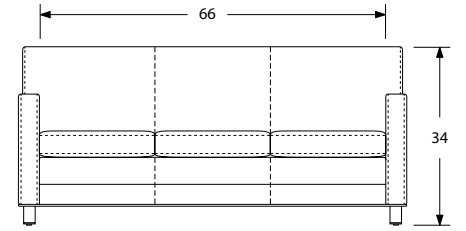
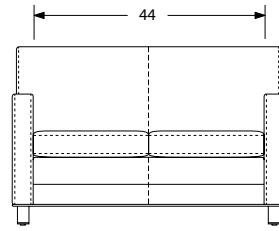
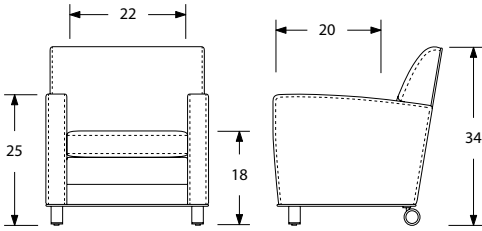
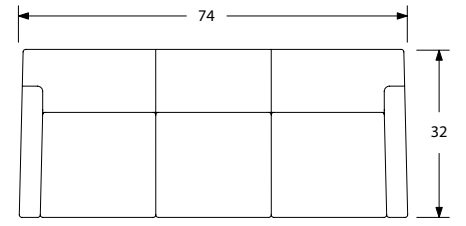
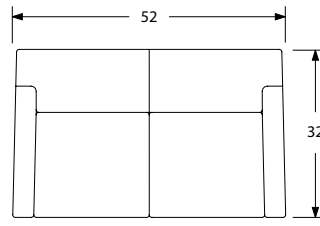
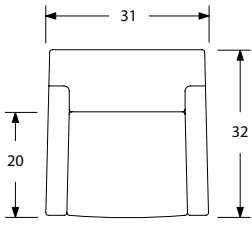

20/900

20/903-52

20/903-74

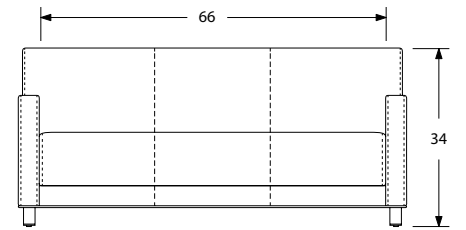
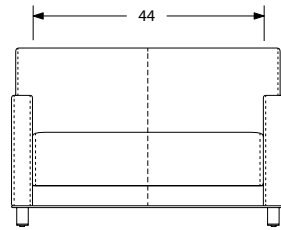
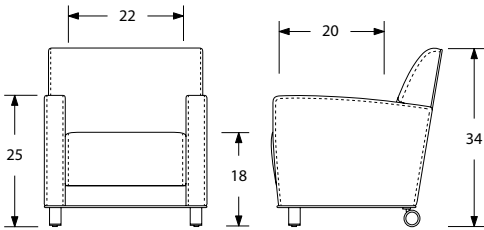
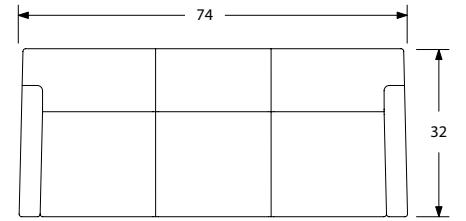
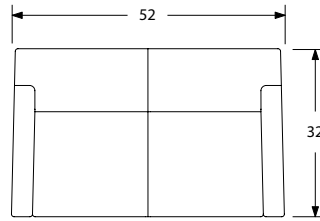
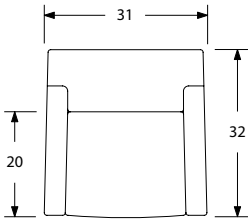

20/905

20/908-52

20/908-74

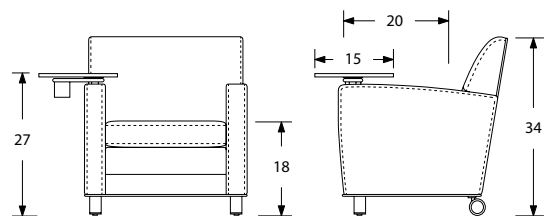
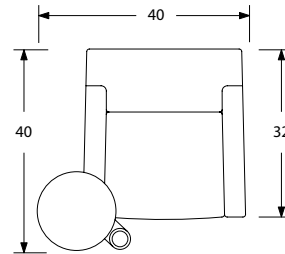

20/905 LC TC



# Sassi

Perfect for occasional seating and to make an artistic statement. The upholstery selected, single textile or multi-fabric, constructs this bench for use in any environment.



## Range Information

- Upholstery frame: reinforced hardwood and plywood
- Seat: polydacron
- Back: polyurethane over hardwood
- Exposed base: 1 ½" x ½" flat tubular, 16 gauge stainless steel, with black plastic glides.  
SS: Super Satin finish. Standard.

**SASSI**

**Code:**

**Description**

**COM**  
**/1**

**2**

**3**

**4**

**5**

**6**

**7**

**8**

**9**

**10**

**COL**

**L1**

**L2**

**L3**

  
**(ly)**

  
**(ft²)**

  
**(lb)**



**20/998 MP**

Bench

2312 2370 2438 2484 2564 2622 2724 2838 2986 3122 2394 3030 3420 4608 2.25 41 -



**20/999 MP**

Bench with  
Back

3396 3490 3604 3680 3812 3906 4076 4264 4508 4734 3526 4580 5226 7198 3.75 68 -

**OPTIONS**

- Multi-fabric application

**TO ORDER**

- 1 Specify Item Number
- 2 Specify Base  
SS ..... STANDARD
- 3 Specify Upholstery Name,  
Color Number And Name
- 4 Specify Options

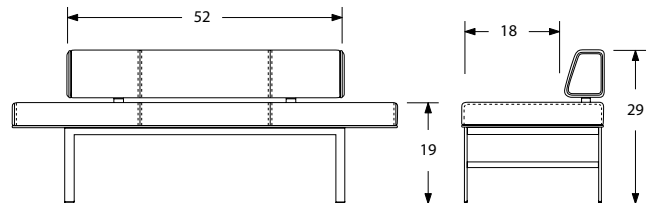
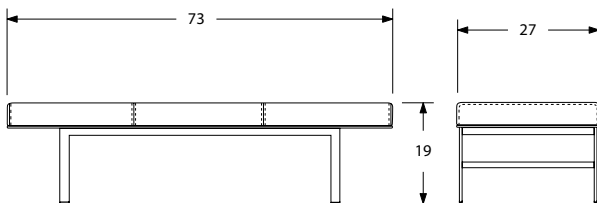
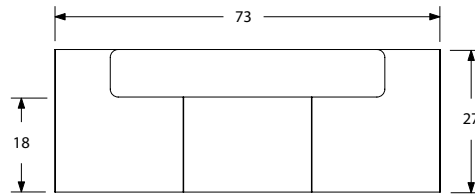
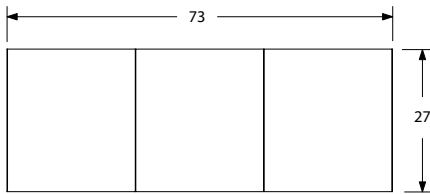

20/998

20/999



**11.**

**Appendix**

A Nema power socket with a 72" lead will be supplied as standard. If you require a longer starter lead please see the Weiland product page for alternate lengths.



**Arc-H LD**  
Page 526



**Pip**  
Page 526



**Panda**  
Page 527



**Phase**  
Page 527



**Pixel**  
Page 528



**Pixel8**  
Page 528



**Pixel TUF A+C**  
Page 529



**Pandora**  
Page 529



**Pulse**  
Page 530



**Pulse8**  
Page 530



**Pathfinder**  
Page 531



**Power Box**  
Page 531



**Qik TRAY**  
Page 532



**Weiland**  
Page 532

# Power & Data – Compatibility

Power and data can be specified for the following product ranges, however please note that not all power unit configurations will fit in all furniture models.

Please contact us before ordering to confirm your power and data requirements, as well as the available placements, with one of our sales specialists.



























## Power & Data Options

Range	ARC-HLD	Pip	Panda	Phase	Pixel	PixelB	Pixel TUF A+C	Pandora	Pulse	Pulse8	Power Box	Qik Tray	Cable Snake
ACDC Desking	•	•	•	•	•	•	•	•	•	•	•	•	•
ACDC Meeting	•	-	-	-	•	•	•	-	-	-	-	-	•
ATOM Meeting Desk	•	-	-	-	•	•	•	•	-	-	-	-	•
Atom Configurations	-	•	-	-	•	•	•	-	-	-	-	-	-
Cocoon	-	-	-	-	•	•	•	-	-	-	-	-	-
Cocoon Media	•	•	-	•	•	•	•	•	•	•	-	-	-
Deploy Flip	•	-	•	•	•	•	•	•	•	•	•	-	•
Deploy Meeting	•	-	•	•	•	•	•	•	•	•	•	-	•
Deploy Static Meeting	•	-	•	•	•	•	•	•	•	•	•	-	•
Indi	•	-	-	-	•	•	•	-	•	•	-	-	•
Layla	•	•	-	-	•	•	•	-	-	-	-	-	-
Layla Landscape	•	•	-	-	•	•	•	-	-	-	-	-	-
Mango	-	-	-	•	-	-	-	-	-	-	-	-	-
Myriad	-	-	-	•	•	•	•	-	-	-	-	-	-
Pegasus	•	-	•	•	•	•	•	•	•	•	•	•	•
Portal	-	-	-	-	-	-	-	-	-	-	-	-	-
Niko	•	-	•	•	•	•	•	•	•	•	•	-	•
Agent Tables	•	-	-	•	•	•	•	•	•	•	-	-	•
Arthur	-	-	-	•	-	-	-	-	-	-	-	-	-
Arthur CityScape	-	-	-	•	-	-	-	-	-	-	-	-	-
Entente High-back	•	•	•	-	•	•	•	•	•	•	-	-	-
Entente Low-back	•	•	•	-	•	•	•	•	•	•	-	-	-
Isla Tables	•	-	-	-	•	•	•	•	-	-	-	-	-
Myriad Side Arm Unit	•	-	-	-	•	•	•	-	-	-	-	-	-
Raft 1 + 2	•	•	-	-	•	•	•	-	-	-	-	-	-
Raft +	-	-	-	•	•	-	-	-	-	-	-	-	-
Snug	•	-	•	•	•	•	•	-	•	•	-	-	-
Snug Plus	•	-	•	•	•	•	•	-	•	•	-	-	-
Reef	•	-	•	•	•	•	•	-	•	•	-	-	-



## ARC-H LD

Product	Description	\$
	<p><b>ARC-H LD price based on:</b></p> <ul style="list-style-type: none"> <li>10W wireless charging power</li> <li>Supports fast charge</li> <li>Foreign Object Detection (F.O.D)</li> <li>LED charging indicator</li> <li>No surface hole required</li> <li>FCC Part 15</li> <li>Includes cETLus certified Power adapter</li> </ul>	
	<p><b>ARC-H (LD) - Through surface wireless charger - Black or White</b></p>	
	<p>ARC - H LD 10W, FCC certified (20 - 30mm), Qi compatible, charger &amp; resonant pad (Gray or White), power adapter &amp; cord *includes ARC - H LD Electronic Installation Alignment Tool</p>	<b>260</b>

## Pip

Product	Description	\$								
	<p><b>Pip price based on:</b></p> <ul style="list-style-type: none"> <li>TUF-RA+C replaceable charger (25W) (where applicable)</li> <li>Available with White, Black or colored bevelled bezel and Gray or Black socket fascia (specify when ordering)</li> <li>72" Starter Cable with male GST18/3 connector</li> <li>Fitted from the front into a 60mm hole</li> <li>Depth required 44mm</li> </ul>									
	<p><b>White or Black bezel</b></p>									
	<p>1 x NEMA socket (Gray)</p>	<b>155</b>								
	<p>1 x TUF-R (A+C)</p>	<b>320</b>								
<table border="0"> <tr> <td> Dark Blue</td> <td> Light Orange</td> </tr> <tr> <td> Light Blue</td> <td> Orange</td> </tr> <tr> <td> Light Green</td> <td> Red</td> </tr> <tr> <td> Yellow</td> <td> Hot Pink</td> </tr> </table>	 Dark Blue	 Light Orange	 Light Blue	 Orange	 Light Green	 Red	 Yellow	 Hot Pink	<p><b>Colored bezel with brushed stainless steel inlay</b></p>	
	 Dark Blue	 Light Orange								
	 Light Blue	 Orange								
 Light Green	 Red									
 Yellow	 Hot Pink									
<p>1 x NEMA socket (Black)</p>	<b>170</b>									
<p>1 x TUF-R (A+C)</p>	<b>335</b>									

## Panda

Product	Description	\$
 	<b>Panda price based on:</b> TUF-RA+C replaceable charger (20W) (where applicable) White front and back with Black socket fascias and Black endcaps (Also available with Black front and back and Black sockets please enquire) 72" Starter Cable with male GST18/3 connector Black fixings with Gray clamp for desks 5-1.4"	
	2 x NEMA socket	<b>255</b>
	1 x NEMA socket, 1 x TUF-R (A+C)	<b>420</b>
	2 x NEMA socket, 1 x TUF-R (A+C)	<b>470</b>

## Phase Black + White

Product	Description	\$
 	<b>Phase Black price based on:</b> TUF-RA+C replaceable charger (5A) (where applicable) Black housing Black socket fascias (Also available with Gray socket fascias please enquire) 108" Starter Cable with male GST18/3 connector Screw-down bracket	
	2 x NEMA socket	<b>235</b>
	1 x NEMA socket, 1 x TUF-R (A+C)	<b>400</b>
	Phase Clamp Bracket (white)	<b>60</b>
 	<b>Phase White price based on:</b> TUF-RA+C replaceable charger (5A) (where applicable) White housing Gray socket fascias 108" Starter Cable with male GST18/3 connector Screw-down bracket	
	2 x NEMA socket	<b>235</b>
	1 x NEMA socket, 1 x TUF-R (A+C)	<b>400</b>
	Phase Clamp Bracket (white)	<b>60</b>

## Pixel - Black

Product	Description	\$
 <p>Spill resistant angled socket</p>	<p><b>Pixel price based on:</b></p> <p>Black housing, silver bezel            72" Starter Cable with male GST18/3 connector            Tool-less fixing kit for 80mm aperture            Depth required 2" (excluding cable)            Keystone mounted USB, Audio and Inline couplers are all optional.</p>	
	<p>1 x NEMA socket            (includes 2 x blanked off keystone apertures)</p>	<b>210</b>



## Pixel - White

Product	Description	\$
 <p>Spill resistant angled socket</p>	<p><b>Pixel price based on:</b></p> <p>White housing, silver bezel            72" Starter Cable with male GST18/3 connector            Tool-less fixing kit for 80mm aperture            Depth required 2" (excluding cable)            Keystone mounted USB, Audio and Inline couplers are all optional.            Pull through RJ45 cables also optional</p>	
	<p>1 x NEMA socket            (includes 2 x blanked off keystone apertures)</p>	<b>210</b>



## Pixel8

Product	Description	\$
 <p>Spill resistant angled socket</p> <ul style="list-style-type: none"> <li><span style="display: inline-block; width: 15px; height: 10px; background-color: #1a3a7a; margin-right: 5px;"></span> Dark Blue</li> <li><span style="display: inline-block; width: 15px; height: 10px; background-color: #00a0e3; margin-right: 5px;"></span> Light Blue</li> <li><span style="display: inline-block; width: 15px; height: 10px; background-color: #76c73a; margin-right: 5px;"></span> Light Green</li> <li><span style="display: inline-block; width: 15px; height: 10px; background-color: #ffcc00; margin-right: 5px;"></span> Yellow</li> <li><span style="display: inline-block; width: 15px; height: 10px; background-color: #ff9900; margin-right: 5px;"></span> Light Orange</li> <li><span style="display: inline-block; width: 15px; height: 10px; background-color: #ff6600; margin-right: 5px;"></span> Orange</li> <li><span style="display: inline-block; width: 15px; height: 10px; background-color: #cc0000; margin-right: 5px;"></span> Red</li> <li><span style="display: inline-block; width: 15px; height: 10px; background-color: #cc0066; margin-right: 5px;"></span> Hot Pink</li> </ul>	<p><b>Pixel8 price based on:</b></p> <p>White or Black housing (please specify when ordering)            Colored bezel (please specify when ordering)            72" Starter Cable with male GST18/3 connector            Tool-less fixing kit for 80mm aperture            Depth required 2" (excluding cable)</p>	
	<p>1 x NEMA socket            (includes 2 x blanked off keystone apertures)</p>	<b>255</b>

## Pixel TUF A+C

Product	Description	\$
 <p>Spill resistant angled socket</p> <ul style="list-style-type: none"> <li style="width: 50%;"><span style="display: inline-block; width: 10px; height: 10px; background-color: #000080; margin-right: 5px;"></span> Dark Blue</li> <li style="width: 50%;"><span style="display: inline-block; width: 10px; height: 10px; background-color: #FFA500; margin-right: 5px;"></span> Light Orange</li> <li style="width: 50%;"><span style="display: inline-block; width: 10px; height: 10px; background-color: #00BFFF; margin-right: 5px;"></span> Light Blue</li> <li style="width: 50%;"><span style="display: inline-block; width: 10px; height: 10px; background-color: #FF8C00; margin-right: 5px;"></span> Orange</li> <li style="width: 50%;"><span style="display: inline-block; width: 10px; height: 10px; background-color: #90EE90; margin-right: 5px;"></span> Light Green</li> <li style="width: 50%;"><span style="display: inline-block; width: 10px; height: 10px; background-color: #DC143C; margin-right: 5px;"></span> Red</li> <li style="width: 50%;"><span style="display: inline-block; width: 10px; height: 10px; background-color: #FFD700; margin-right: 5px;"></span> Yellow</li> <li style="width: 50%;"><span style="display: inline-block; width: 10px; height: 10px; background-color: #FF69B4; margin-right: 5px;"></span> Hot Pink</li> </ul>	<p><b>PixelTUF A+C price based on:</b></p> <p>TUFA+C charger (25W)            Silver or colored bezel (as options below)            72" Starter Cable with male GST18/3 connector            Tool-less fixing kit for 80mm aperture            Integral snap-out feature to allow cable pull through for cables up to Ø0.3"            Depth required 2" (excluding cable)</p> 	
<b>Pixel TUF A+C Black (with silver bezel)</b>		
1 x NEMA socket, 1 x TUFA+C		<b>385</b>
<b>Pixel TUF A+C White (with silver bezel)</b>		
1 x NEMA socket, 1 x TUFA+C		<b>385</b>
<b>Pixel TUF A+C-8 (Black or White with colored bezel)</b>		
1 x NEMA socket, 1 x TUFA+C		<b>425</b>





## Pandora

Product	Description	\$
 <p>Inlay</p>	<p><b>Pandora price based on:</b></p> <p>TUF-RA+C replaceable charger (25W) (where applicable)            Inlay version available in Black. Bevelled version available in Black or White.            With Black or Gray socket fascias            72" Starter Cable with male GST18/3 connector (via base)            Pandora is available with power only            Tool-less clamping kit to fit 5" aperture            Depth required for Bevelled 99mm and 101mm for Inlay            Spill resistant angled sockets</p> 	
<b>Inlay frame - Black with stainless steel bezel</b>		
3 x NEMA socket		<b>385</b>
2 x NEMA socket, 1 x TUF-R (A+C)		<b>550</b>
<b>Bevelled frame - Black</b>		
3 x NEMA socket		<b>370</b>
2 x NEMA socket, 1 x TUF-R (A+C)		<b>535</b>
<b>Bevelled frame - White</b>		
3 x NEMA socket		<b>370</b>
2 x NEMA socket, 1 x TUF-R (A+C)		<b>535</b>





























**NOTE:** Inlay version has screw fixing to allow installation without rear access.



## Pulse

Product	Description	\$
	<p><b>Pulse price based on:</b></p> <p>TUFA+C charger (25W)            Silver or colored bezel (as options below)            72" Starter Cable with male GST18/3 connector            Tool-less fixing kit for 80mm aperture            Integral snap-out feature to allow cable pull through for cables up to Ø0.3"            Depth required 2" (excluding cable)</p> 	
	<p>3 x NEMA socket, 1 x TUF-R (A+C)</p>	<p><b>475</b></p>
	<p>4 x NEMA socket</p>	<p><b>310</b></p>

## Pulse8

Product	Description	\$								
	<p><b>Pulse8 price based on:</b></p> <p>TUF-RA+C replaceable charger (25W) (where applicable)            Colored housing (please specify when ordering)            Gray or Black socket fascias (please specify when ordering)            72" Starter Cable with male GST18/3 connector            Black or Gray clamp bracket for desks 15-1.4" (dependent on Color configuration)            Integral laptop locking aperture</p> 									
	<p>3 x NEMA socket, 1 x TUF-R (A+C)</p>	<p><b>535</b></p>								
<table border="0"> <tr> <td> Dark Blue</td> <td> Light Orange</td> </tr> <tr> <td> Light Blue</td> <td> Orange</td> </tr> <tr> <td> Light Green</td> <td> Red</td> </tr> <tr> <td> Yellow</td> <td> Hot Pink</td> </tr> </table>	 Dark Blue	 Light Orange	 Light Blue	 Orange	 Light Green	 Red	 Yellow	 Hot Pink	<p>4 x NEMA socket</p>	<p><b>365</b></p>
 Dark Blue	 Light Orange									
 Light Blue	 Orange									
 Light Green	 Red									
 Yellow	 Hot Pink									



## Pathfinder

Product	Description	\$
 	<b>Pathfinder price based on:</b> Flexible umbilical cable management system Available in clear, White, or Silver Internal segregation for power and data cables Extendible sections Wide range of fixing options and accessories available Available in four colors	
	Pathfinder 30.75" TWB White - Weighted Base	<b>125</b>
	Pathfinder 30.75" TWB Silver - Weighted Base	<b>125</b>
	Pathfinder 30.75" TWB Black - Weighted Base	<b>125</b>
	Pathfinder Zipper	<b>40</b>
	Pathway Adaptor	<b>45</b>

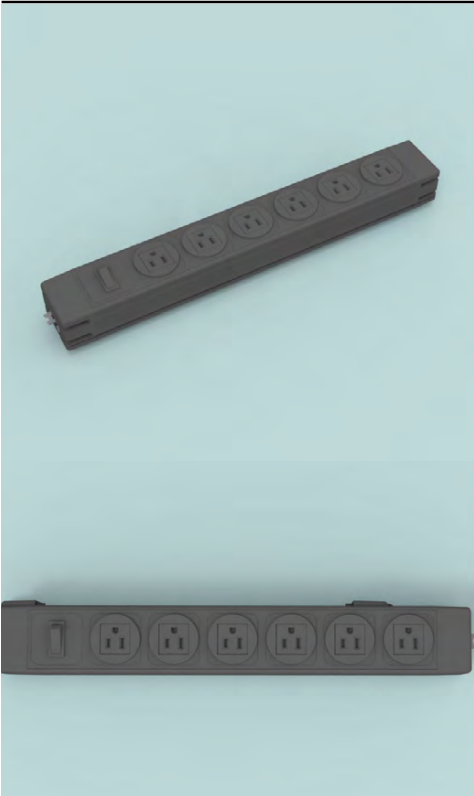

## Powerbox

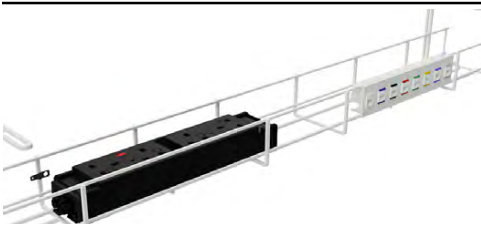
Product	Description	\$
	<b>Powerbox price based on:</b> Up to 8 Nema 5-15R sockets (TR optional) TUF-R A+C 25W USB charger Integral 15A resettable OCP rocker switch Data fascia with keystone opening(s) available Standard 108" Nema 5-15P cord	
	4 NEMA sockets, 15A OCP rocker switch, Female GST exit w/ cap, mount (HW5018), 72" HW NEMA cord (black)	<b>275</b>
	4 NEMA sockets, 15A OCP rocker switch, Female GST exit w/ cap, mount (HW5018), 108" HW NEMA cord (black)	<b>285</b>
	6 NEMA sockets, 15A OCP rocker switch, Female GST exit w/ cap, mount (HW5018), 72" HW NEMA cord (black)	<b>345</b>
	6 NEMA sockets, 15A OCP rocker switch, Female GST exit w/ cap, mount (HW5018), 108" HW NEMA cord (black)	<b>355</b>
	8 NEMA sockets, 15A OCP rocker switch, Female GST exit w/ cap, mount (HW5018), 72" HW NEMA cord (black)	<b>415</b>
	8 NEMA sockets, 15A OCP rocker switch, Female GST exit w/ cap, mount (HW5018), 108" HW NEMA cord (black)	<b>425</b>
	<b>Powerbox Accessories</b>	
	Powerbox Modesty panel mount (Pair)	<b>50</b>
	Powerbox Screw mount (Pair)	<b>10</b>
Powerbox Under desk mount	<b>50</b>	

## Qik Tray

Product	Description	\$
	<p><b>Qik Tray price based on:</b></p> <p>Available in two lengths: 2ft and 3ft with two mounting points            Available in White Only            Single tier baskets are stackable (shown left)            Single tier units can be used back to back            Compatible with Pathfinder mounting bracket, QikBox,            Powerunit, Powerbox, Powerbox            Simple 'click in, click out' installation</p>	
	<p>QikTray 2 ft - White</p>	<p><b>65</b></p>
	<p>QikTray 3 ft - White</p>	<p><b>80</b></p>
	<p><b>Optional extras</b></p>	
	<p>Powerbox clips (to allow Powerbox to clip onto pathway)</p>	<p><b>10</b></p>

## GST Starter Cables

Product	Description	\$
	<p><b>GST Starter Cable price based on:</b></p> <p><b>USA Starter Leads</b></p>	
	<p>72" 14/3 SJT to female GST 18i3 connector (15A OCP) to Nema 5 - 15 plug</p>	<p><b>60</b></p>
	<p>108" 14/3 SJT to female GST 18i3 connector (15A OCP) to Nema 5 - 15 plug</p>	<p><b>100</b></p>
	<p>180" 14/3 SJT to female GST 18i3 connector (15A OCP) to Nema 5 - 15 plug</p>	<p><b>120</b></p>



# Seating Timber Finishes & Stains

This section is to be used as a visual color representation only. If you require accurate swatch samples please contact our sales office who will be able to supply them to you.

Please note that not all finishes listed here are available on every product in our portfolio, so please check the product specifications listed on the product pages for compatibility.

## Boss - Standard Wood Veneer Finishes



American Black Walnut

Oak

Beech with clear lacquer

## Boss - Beech Stains



Beech with Cherry stain

Beech with Dark Oak stain

Beech with Ebony stain

Beech with Light Oak stain

Beech with Mahogany Stain

Beech with Walnut stain

Beech with Wenge stain

## Boss - Stained Frames - Oak

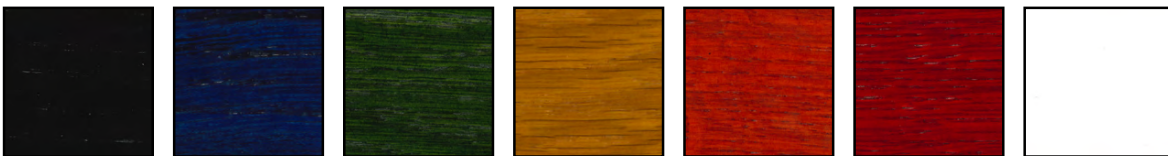

Black Stain with 10% Clear Lacquer

Blue Stain with 10% Clear Lacquer

Green Stain with 10% Clear Lacquer

Yellow Stain with 10% Clear Lacquer

Orange Stain with 10% Clear Lacquer

Red Stain with 10% Clear Lacquer

White Stain with 10% Clear Lacquer

## Cartwright - Wood Finishes



Light Oak

Medium Oak

Dark Oak

Amber Cherry

Light Maple

Natural Walnut

Natural Mahogany

Cordovan Mahogany



Burnt Umber

Natural Maple

# Metal & Plastic Finishes

This section is to be used as a visual color representation only. If you require accurate swatch samples please reference a RAL swatch card.

Please note that not all finishes listed here are available on every product in our portfolio, so please check the product specifications listed on the product pages for compatibility.

## Boss - Standard Metal Finishes

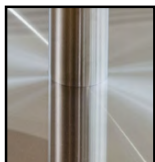

Polished  
Aluminum



Stainless  
Steel



Satin Silver

## Boss - RAL Colors



RAL 9005

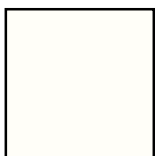

RAL 9016

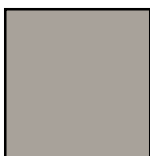

RAL 060 60 05

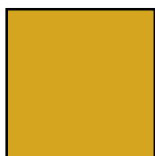

RAL 070 70 80

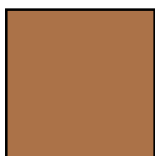

RAL 040 50 50



RAL 130 30 20



RAL 240 20 22

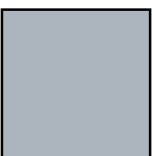

RAL 220 70 10

## Boss - Table Leg/Credenza Wire Foot Finishes

RAL colors outside of these standard optional are price on a POA basis and are subject to MOQ's.

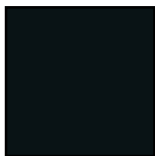

RAL 9005

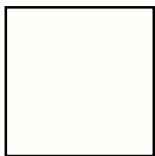

RAL 9016

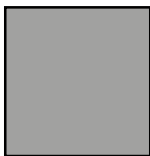

RAL 9006

# Table Top & Credenza Finishes

## Veneers - Standard Color Options



American Black  
Walnut

Oak

Beech

Cherry

Maple

Ash

## Fenix - Standard Color Options

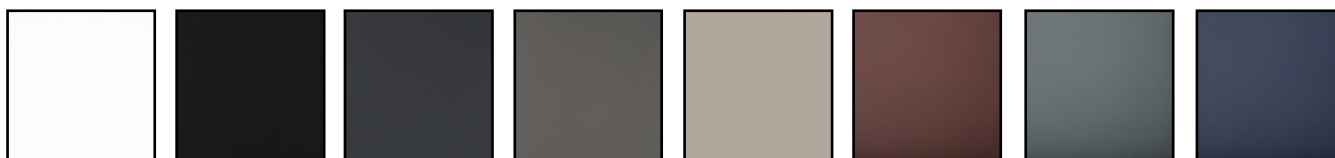

Bianco Kos  
0032

Nero Ingo  
0720

Grigio Bromo  
0724

Titanio Doha  
2638

Beige Arizona  
0748

Rosso Jaipur  
0751

Verde  
Comodoro 0750

Blu Fes  
0754

## Compact Laminate - ATOM Tables Standard Color Options

Black Edged - Available on ATOM & Flamingo Tables Only



111 - Designer  
White

116 - Pearl Gray











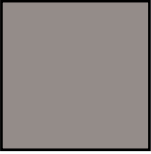







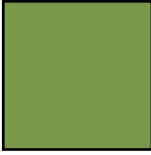





149 - Sheer

261 - Dark Gray

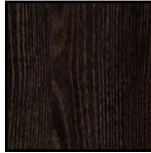
271 - Light Gray

401 - Black

## Laminate Color Options

							
Arctic Gray U788	Light Gray U708	Premium White W1000	Platinum White W980	Glacier Blue U500	Denim Blue U540	Delft Blue U525	French Blue U515
							
Lime Green U650	Kiwi Green U626	May Green U600	Maize Yellow U146	Indian Red U390	Diamond Gray U963	Black U999	
							
Carini Walnut H3710	Lancaster Oak H3368	Champagne Maple H3860	Ellmau Beech H1582	Black Brown Thermo Oak H1199	Gray Nebraska Oak H3332	Gray Vicenza Oak H3158	Natural Bardalino Oak H1145
							
White Carrara Marble F204	Light Gray Chicago Concrete F186						



**Textiles**

# Graded-In Textiles

For a list of each of our partner company's patterns with Boss Design Grades visit [www.bossdesign.com](http://www.bossdesign.com). To order memo samples visit the websites or call the numbers listed below

**ANZEA**

memo samples: [www.anzea.com](http://www.anzea.com) or 877-862-6932

**ArcCom**

memo samples: [www.arc-com.com](http://www.arc-com.com) or 800-223-5466

**Architex**

memo samples: [www.architex-ljh.com](http://www.architex-ljh.com) or 800-621-0827

**BRAYTON**

PAUL BRAYTON DESIGNS

memo samples: [www.paulbraytondesigns.com](http://www.paulbraytondesigns.com) or 800-882-4720

**camira**

memo samples: [www.camirafabrics.com](http://www.camirafabrics.com) or 616-288-0655

**DESIGNTEX**

memo samples: [www.designtex.com](http://www.designtex.com) or 800-221-1540

**green hides**

LEATHER STUDIO

memo samples: [www.greenhides.com](http://www.greenhides.com) or 888-326-0122

**kvadrat**

memo samples: [www.kvadrat.dk/en](http://www.kvadrat.dk/en) or 1-800-620-9309

**maharam**

memo samples: [www.maharam.com](http://www.maharam.com) or 800-645-3943

**MOMENTUM**

TEXTILES

memo samples: [www.themomgroup.com](http://www.themomgroup.com) or 800-366-6839



**PALLAS**

memo samples: [www.pallas.com](http://www.pallas.com) or 616-288-0655

**Stinson**

memo samples: [www.cfstinson.com](http://www.cfstinson.com) or 800-841-6279



memo samples: [www.ultrafabricsinc.com](http://www.ultrafabricsinc.com) or 877-309-66648

• Indicate GRADED-IN TEXTILE on your order and Boss Design will order the fabric and produce the specified furniture.

• Boss Design reserves the right to adjust grades to accommodate price changes received from our suppliers.

• Refer to our website [www.bossdesign.com](http://www.bossdesign.com) for complete pattern lists with corresponding Boss Design grades. Fabrics priced above our grade levels and those with exceptionally large repeats are indicated with "CALL". Please contact Customer Service for pricing.

• Orders are subject to availability of the fabric from the supplier.

• Furniture specified using multi-fabric applications or contrasting welts may be up charged.

• Textiles offered in the Graded-in Textiles program are non standard materials and are considered Customer's Own Materials (COM). Because COMs are selected by and used at the request of a user, they are not warranted. It is the responsibility of the purchaser to determine the suitability of a fabric for its end use.

• In the absence of specific application instructions, Boss Design will apply the fabric as it is sampled by the source and as it is displayed on their website.

**• MEMO SAMPLES MUST BE ORDERED DIRECTLY FROM THE FABRIC SUPPLIER.**

• **NOTE:** Backing may be required on some materials for proper tailoring on Boss Design furniture. Additional backing charges may be incurred and will be the responsibility of the customer.

• **NOTE:** Cancellation of an order requiring Graded In fabric will be determined by our ability to cancel any fabric ordered. Customer will be responsible for restocking fees and any shipping costs incurred.

• **NOTE:** Within the Graded In program, not every fabric is approved for every style of Boss Design furniture. Please contact customer service for confirmation that your selected fabric is approved for use on the intended product.

**SPECIFY ON ORDER:**

**INDICATE GRADED-IN TEXTILE ON ORDER**

- Boss Design Furniture Item number, quantities and options
- Fabric Source
- Fabric Name/Number and Color Name
- Include specific instructions for the application of the fabric on the furniture to indicate pattern/stripe direction, right side of reversible fabrics, etc. In the absence of specific instructions, Boss Design will apply the fabric as it is sampled by the supplier.

# Boss Design Textiles

Swatch Cards and memo samples can be ordered from Customer Service 844.353.7834.

## • DERBY

GRADE L1 List price \$11.65 / Sq. Ft.  
Top Grain Leather  
Semi-Aniline  
50-55 Sq. Ft. Hides

### Meets flammability codes:

- California Bulletin #117-2013 (CS 191-53)
- NFPA-260 Class 1
- BFD 1X-1

6500 Sage

6501 Black

6502 Bone

6503 Fawn

6504 Charcoal

6505 Saddle

6507 Royal

6508 Port

6509 Moss

6514 Blueberry

6517 Dark Red

6518 Dark Chocolate

6519 Dark Brown

6520 Tan

6521 Parchment

6522 Oyster

6523 Ivory

6524 Doe

6526 White

6527 Bright White

6528 Light Gray

6529 Quartz

6530 Flint

6531 Pewter

6532 Red

## • ASPEN

GRADE L2 List Price \$19.00 / Sq. Ft.  
Chrome Free Leather  
Semi-Aniline: Natural Grain  
Synthetic vegetable tanned  
Breathable water based protective finish  
55 Sq. Ft. Hides

### Meets flammability codes:

- California Bulletin #117-2013 (CS 191-53)
- BFD 1x-1
- MVSS 302

6901 Avocado

6902 Black

6903 Bone

6904 Camel

6905 Caramel

6906 Chateau

6907 Cherry

6908 Chocolate

6909 Clover

6910 Cocoa

6911 Deep Earth

6912 Eggshell

6913 Fawn

6914 Grape

6915 Graphite

6916 Honeydew

6917 Indigo

6918 Ivory

6919 Lagoon

6920 Magnolia

6921 Orange

6922 Parchment

6923 Persimmon

6924 Russett

6925 Saddle

6926 Safari

6927 Sage

6928 Spirit

6929 Tan

6930 Teak

6931 Tobacco

## • CLASSIC

GRADE 2 List Price \$63.00 / Yard  
100% Vinyl Face, Polyester Knit Back  
54" Wide  
Exceeds 500,000 Double Rubs - Wyzenbeek

### Meets flammability codes:

- California Bulletin #117-2013
- UFAC Class 1  
BIFMA  
NFPA 260  
MVSS 302  
BFD 1X-1  
(Recommended With Appropriate Components)

SCL 001 Admiral

SCL 003 American Beauty

SCL 201 Aniseed

SCL 202 Appalachian

SCL 203 Barley

SCL 204 Bedrock

SCL 005 Black

SCL 006 Blue Ridge

SCL 008 British Tan

SCL 009 Buff

SCL 010 Burgundy

SCL 205 Buttercream

SCL 206 Carnation

SCL 011 Cashew

SCL 012 Cayenne

SCL 014 Chocolate

SCL 207 Citrine

SCL 015 Claret

SCL 208 Comet

SCL 209 Daffodil

SCL 016 Doe

SCL 210 Fern

SCL 211 Flan

SCL 106 Fog

SCL 018 Fudge

SCL 212 Galleon

SCL 019 Granite

SCL 213 Granny Smith

SCL 020 Grape

SCL 214 Gunite

SCL 215 Gypsum

SCL 216 Horizon

SCL 107 Lake

SCL 217 Malbec

SCL 108 Marshmallow

SCL 218 Maui

SCL 026 Mocha

SCL 219 Morel

SCL 220 Mortar

SCL 109 Mustang

SCL 027 Navy

SCL 029 Papyrus

SCL 030 Persimmon

SCL 031 Pewter

SCL 221 Picholine

SCL 222 Porcini

SCL 111 Reef

SCL 112 Rodeo

SCL 032 Rouge

SCL 034 Saddle

SCL 223 Safflower

SCL 035 Saffron

SCL 036 Sage

SCL 040 Stone

SCL 114 Tandoor

SCL 041 Taupe

SCL 224 Wave

SCL 225 Wisp

**NOTE:** Leather is a natural product that will display its natural characteristics of healed scars, color variations and surface irregularities. As a natural material, leather may wrinkle or puddle with use.

# Upholstery Options

## CUSTOMER'S OWN MATERIAL/CUSTOMER'S OWN LEATHER

- Boss Design will apply fabric, faux leather, or leather supplied by the customer on our furniture.
- Indicate COM/COL on order.
- Yardage requirements found in the Price List are based on 54" wide plain covering material. Yardage must be increased if material is less than 54", the pattern requires matching or the fabric has a nap or pile.
- For fabrics with a repeat, fabrics less than 54" wide, or fabrics with a nap or pile, email customerservice@bosssdesign.com for COM yardage requirements. A COM request must include Boss Design style number and quantity, a memo of the selected textile and a complete description of the fabric including fabric source, Pattern/Color Name and Number, fabric width and repeat, finishing information and direction fabric is to be applied on furniture (direction of pattern or stripe, right side of reversible fabrics, etc.).
- In the absence of specific application instructions, Boss Design will apply the fabric using our best judgment.
- Leather requirements are based on the formula of 18 square feet of leather equals 1 linear yard of 54" wide material. Hides measuring less than 45 square feet and suede leathers may require additional square footage. Contact Customer Service for specific square footage required.
- Furniture specified using multi-fabric applications or contrasting welt will be up charged.
- We cannot be responsible for defects, color inaccuracies, dye lot variations and other flaws in COM/COL. We suggest that our customers inspect fabrics before furnishing them.
- We reserve the right to reject any covering which, in our opinion, is unsuitable for upholstery purposes.
- COM/COL orders cannot be scheduled for production until all of the upholstery has been received and inspected by Boss Design.

## SPECIFY ON ORDER: INDICATE COM/COL ON ORDER

- Boss Design Item number, options and quantity
- Attach sample with full identification of fabric including name of supplier, fabric name/number and color name/number.
- Specific application instructions (direction of pattern or stripe, right side of reversible fabrics, etc.). In the absence of specific application instructions, Boss Design will apply the fabric using our best judgment.
- NOTE: We will not be responsible for errors caused by customers' failure to supply us with complete information.

## SHIPPING OF COM/COL TO BOSS DESIGN

### Include the following information of purchase order:

- Boss Design acknowledgment number
- Customers' firm name, job and order number
- Boss Design item number and quantity.
- Ship prepaid to:

## BOSS DESIGN

**2014 CHESTNUT STREET  
HIGH POINT, NC 27262**

COM/COL orders shipped to BOSS freight collect will be refused.

## MULTI-FABRIC APPLICATIONS

All purchase orders that request two tone or multi fabric applications, must also have a signed specification sheet filled in by the customer with clear instructions for the location of each fabric selection. This prevents any potential confusion to the application. These specification sheets can be requested from Customer Service. 5% of the net cost will be charged for COM Two Tone applications. Two tone application using Graded in Fabrics are priced at the higher grade with no extra charge.

## CALIFORNIA TECHNICAL BULLETIN 117-2013

All Boss Design filling materials (foam, polydacron, polyurethane, wetting cord) conform to Cal TB 117-2013.

# Wood Painted Frames



## Red

Orten Small Armchair + Triad Medium Table



## Orange

Metro Coffee Table



## Yellow

542 Agent Dining Chair with Arms + Agent Side Table



## Green

Callisto Barstool + Agent High Table



## Blue

Keats Chair with Arms



## Black

Mr Armchair + 120 Coffee Table



## White

Triad High Table

## Wood Painted Frames

Introducing a spectrum of painted frame options to the Boss Design portfolio.

Choose from our standard color collection or be distinctive with a bespoke finish based on a RAL color.

Create a striking aesthetic by applying color to exposed timber frames of our seating and table collections.

Color samples are available upon request.

**\$ - See product page for pricing**

# Ordering Instructions

## General

---

All prices are expressed in **USD** and are exclusive of any taxes. All sales of the company's products will be governed by our standard conditions of sale.

## Acknowledgement of Orders

---

The order acknowledgement constitutes the contract to supply. Please check all order acknowledgements and contact Boss Sales Office within 24 hours if there are any discrepancies.

## Technical Specifications

---

All dimensions are in inches and are nominal. Foam refers to Combustion Modified High Resilient Foam.

## Color Variations

---

While every effort is made to ensure parity of color, the company can not guarantee an exact match on any wood or metal finish or guarantee against commercial variances in fabrics, especially on repeat orders.

## Care of Wood Finishes

---

The fine finish applied during manufacture is a hard protective lacquer resistant to moderate heat and spillages of some beverages, but not alcohol. All spillages should be wiped off immediately with a damp cloth. The only cleaning necessary is again to wipe with a slightly damp cloth and buff with a soft duster.

## Painted Finishes

---

We take every precaution to ensure that high gloss and painted finished products reach you in a satisfactory condition. Boss Design will not be held responsible for any damage caused to these products when in use.

## Care of Fabric Upholstery

---

For advice on cleaning please contact our sales office:

Boss Design U.S.A t: 1-844-353-7834  
customerservice@bossdesign.com

## Care of Leather Upholstery

---

Wipe with a slightly damp cloth and gently rub dry. A good proprietary hide food should be applied at least once a year and more often if the leather is in a dry atmosphere or close to a heat source.

## Warranty

---

All Boss Design Group products are comprehensively guaranteed for a period of 5 years, fair wear and tear.

## Delivery Instructions

---

When delivering large furniture pieces including sofa ranges and tables we recommend discussing suitability of access with us to ensure that we can make the necessary arrangements to ensure safe and satisfactory delivery.

## Maintenance

---

Please contact the relevant sales office for continued maintenance of your product.

Boss Design U.S.A t: 1-844-353-7834

## Ordering

---

All orders must be placed in writing with the factory. When placing an order, please remember to state:

- Your official purchase order number
- The model range
- Part number code
- The fabric range and description
- The quantity
- The delivery address
- The delivery date
- The price

## Lead times

---

Our standard factory leadtimes are generally between 6 to 10 weeks but are subject to change. For soft seating products the leadtime may be affected by the upholstery fabrics/leathers selected. If you require a delivery sooner than this, please contact:

Boss Design U.S.A t: 1-844-353-7834  
customerservice@bossdesign.com

## Environmental and Social Impact

---

We are passionate about caring for our society and the environment and take every step to ensure that our products, people and process have a positive impact on the environment. We work with credible suppliers who use only ethically sourced materials and components. We design our products with the environment in mind and quality permitting we ensure that they contain the highest possible level of end-of-life recyclability. We work closely with our partners to deliver our end-of-life product management process. We arrange for redundant furniture to be collected and redistributed to charities and other good causes. Unsuitable furniture is always broken down and recycled to ensure zero products go to landfill.

## Freight On Board Program

---

Boss Design Delivers by way of common carrier across across North America on a freight quoted basis. Delivery is based upon standard Warehouse Dock and does not include installation, unpacking or inside locations. Outside Mainland USA, freight is included using the above theory to port of exit. All deliveries are made during normal office hours and during the working week of Monday through Friday.

## Fabric Puddling

---

Certain fabrics may stretch over time and use and may not contract.

Boss Design cannot be held responsible for these fabrics specified by the customer.

## COM and COL Process

---

Boss Design are both COM and COL friendly but unless previously used, cannot guarantee the outcome of these materials by way of just a memo sample. Sometimes a fabric is not properly tested until the chair has been fully upholstered. As a business we must test all materials for approval for each and every chair. While we may approve said fabric that it can be applied to a chair from a memo, Boss will not be held responsible nor do we warranty the over all outcome and appearance of the upholstery. Boss Design reserves the right to reject fabrics even after taking delivery of the COM/COL. We will however as a business, have constant dialogue with the customer through out the process with any concerns at various stages we may have. A 5% of net will be charged for COM Two Tone applications.

Yardage requirements are based on 54" wide, plain fabric. Fabrics with a repeat that requires matching, or with a nap or pile, or less than 54" in width, may require additional yardage for production. Please contact customer service for the yardage requirement.

Please have all COM Tagged and with any specific instruction such as direction, sent to:

**Boss Design,  
2014 Chestnut Street Ext,  
High Point. N.C. 27262**

Without any instruction, we will apply as per the manufacturers recommendation and Boss Design will use our own discretion and at the customers own risk.

Warranty of fabric falls completely with the Vendor of the fabric specified.

## Zipper Colors

---

Zipper colors where used will be matched as best we can using our standard zipper colors. Please specify if a specific color is required.

## Multi Fabric Application

---

All purchase orders that request two tone or multi fabric applications, must also have a signed specification sheet filled in by the customer with clear instructions for the location of each fabric selection. This prevents any potential confusion to the application. These specification sheets can be requested from Customer Service. 5% of the net cost will be charged for COM Two Tone applications. Two tone application using Graded in Fabrics are priced at the higher grade with no extra charge.

### **CALIFORNIA TECHNICAL BULLETINS 117-2013 AND 133**

All Boss Design filling materials (foam, polydacron, polyurethane, welting cord) conform to Cal TB 117-2013.

## Distribution within USA

---

Orders are delivered following a daily schedule. An additional charge will be made if you require delivery on a SPECIFIC day or out of normal working hours.

We use common carriers across N. America.

## Continuous Improvement

---

The company reserves the right to make without notice, any changes in materials, specifications or design of the goods which having regard to all circumstances it considers to be reasonable or desirable but which do not affect the operational requirements of the goods and such changes shall not affect the validity of the contract.

## 1 BASIS OF CONTRACT.

- 1.1. These Terms and Conditions ("Terms"), together with the provisions in any written proposal, purchase order acknowledgement or other document issued or executed by Jack Cartwright Inc. including under the trade and/or brand names of Boss Design and/or Jack Cartwright ("Company") (collectively, "Contract"), constitute the entire agreement between Company and Customer concerning the sale of non-consumer goods by Company to Customer ("Goods").
- 1.2. Each order for Goods by Customer from Company shall be deemed to be an offer by Customer to purchase Goods subject to these Terms. Customer's issuance of any purchase order to Company or acceptance of any Goods supplied by Company shall constitute Customer's acceptance of these Terms. It is Customer's obligation to ensure that the terms of its order and any applicable specifications are complete and accurate.
- 1.3. Any variation to these Terms and any representations about the Goods including any purported oral modifications shall have no effect unless expressly agreed in writing and executed by Company.
- 1.4. No order placed by Customer shall be deemed to be accepted by Company until a written acknowledgement of order is issued by Company. Any order shall be accepted entirely at the discretion of Company.
- 1.5. Any quotation or estimate made by Company shall not constitute an offer and is given subject to these Terms. If Company is deemed to have made an offer to Customer, acceptance shall be limited to the terms offered in writing by Company, including these Terms and Company objects to any additional, omitted or inconsistent terms submitted or proposed by Customer. Quotations will be valid for 30 days from date of issue.
- 1.6. Any order by Customer accepted by Company in whole or in part in accordance with Section 1.4 is final and binding and may only be amended or cancelled by Customer with Company's prior written consent. If Customer amends or cancels an order with Company's prior written consent, it shall be liable to pay to Company all costs reasonably incurred by Company, or which Company is committed to incur, in fulfilling the order up until the date of Company's acceptance of the amendment or cancellation, together with Company's loss of profit on the Contract.

## 2 DELIVERY AND ACCEPTANCE OF GOODS.

- 2.1. Unless otherwise agreed in writing by Company, delivery of the Goods shall be Ex-Works Company's factory (High Point, NC) on international orders and FOB (High Point, NC) on shipments within the continental USA.
- 2.2. Unless otherwise instructed, Company reserves the option to ship by its preferred option at Customer's cost. Upon request, Company will prepay freight for accounts with established credit and a service charge of the freight bill, will be added. Company will use commercially reasonable efforts to ship orders complete and on schedule, however, Company reserves the right to make partial shipments as Goods are

ready.

- 2.3. Any dates specified by Company for delivery of the Goods are intended to be an estimate only and time for delivery shall not be of the essence. If no dates are so specified, delivery will be within a reasonable time. Company shall not be liable for any delay in delivery of the Goods that is caused by a Force Majeure Event (as defined below) or Customer's failure to provide the Supplier with adequate delivery instructions or any other instructions that are relevant to the supply of the Goods.
- 2.4. If for any reason Customer does not accept delivery of any of the Goods when they are ready for delivery or Company is unable to deliver the Goods on time because Customer has not provided appropriate instructions, documents, licences, payments, or authorizations, then the Goods will be deemed to have been delivered on the date and time specified by Company as the time of delivery, risk shall pass to Customer (including for loss or damage caused by Company's negligence) at such time and Company shall store the Goods until delivery takes place and may charge Customer for the costs of transfer and storage and/or the following charges: (i) where Customer fails to notify or notifies Company of the delay less than 72 hours prior to the time of delivery: 5% of the value of the order per week of delay; or (ii) in all other cases: 2.5% of the value of the order per week of delay.
- 2.5. Customer will be deemed to have accepted the Goods as being in accordance with the Contract unless Customer notifies Company in writing of any defect or other failure of the Goods to conform with the Contract within 3 days of the date of delivery of the Goods. Failure to make a claim within said period shall constitute acceptance of the Goods by Customer and Customer shall not be entitled to reject the Goods and Company shall have no liability for such defect or failure and Customer shall be bound to pay the price as if the Goods had been delivered in accordance with the Contract.
- 2.6. Goods, once delivered, may not be returned unless their return is agreed in advance in writing by Company and subject to the following conditions: (i) Goods are returned in a new and unused condition; (ii) any packaging remains unbroken and in reasonably good condition; (iii) returns are made within 2 weeks of delivery of those Goods, all transport and other re-delivery costs of whatever nature are paid by Customer; and (iv) returned goods shall be accompanied by a written record of invoice number, date and a description of reasons for their return.
- 2.7. In the event Goods are received that were damaged in transit, Customer should file a claim with the common carrier immediately and keep the original shipping box for inspection by the carrier. Claims for damage or shortage should be filed with the carrier within 5 days of delivery. All claims against Company for defects, errors, or shortages shall be otherwise made in accordance with these Terms.

## 3 PASSING OF RISK AND LEGAL TITLE.

- 3.1. Customer shall have all risk of loss following delivery of the Goods by Company to the common carrier. Notwithstanding

the foregoing, equitable title and ownership to the Goods shall remain with Company until Company has received full payment thereto.

- 3.2. To secure payment of the purchase price and any other amounts due to Company from Customer under the terms of the Contract, Customer hereby grants Company (as Secured Party) a purchase money security interest in the Goods and the proceeds thereof. Customer hereby gives Company the authorization to sign and file a financing statement (UCC 1 Form) securing the interest of Company to the Goods. To enforce Company's security interest, Company shall have all of the rights and remedies available to a secured party under the Uniform Commercial Code and other applicable laws.

#### 4 PRICE AND PAYMENT.

- 4.1. Unless otherwise agreed by Company in writing, the price for the Goods shall be the price set by Company on the date of delivery or deemed delivery of the Goods. Company reserves the right to change prices without prior notice.
- 4.2. Unless otherwise agreed in writing, the price for the Goods shall be exclusive of any sales or value added tax, tariffs or customs charges and all costs or charges in relation to packaging, labelling, loading, unloading, carriage, freight and insurance all of which amounts Customer will pay, where appropriate, when it is due to pay for the Goods.
- 4.3. Company may invoice Customer for the Goods on or at any time after delivery.
- 4.4. Payment for the Goods is due NET 30 days from the date of invoice with credit Time for payment shall be of the essence. Cash customers will be required to pay a 50% deposit prior to production and 50% final balance before shipping.
- 4.5. Customer shall make all payments due under the Contract in full without any deduction whether by way of set-off, withholding, counterclaim, discount, abatement or otherwise.
- 4.6. If any sum due from Customer to Company under the Contract or any other contract is not paid on or before the due date for payment then, in addition to all other remedies available to Company under applicable law, all sums then owing by Customer to Company shall become due and payable immediately and Company shall be entitled to: (i) cancel or suspend its performance of the Contract or any order including suspending deliveries of the Goods; (ii) require Customer to pay for Goods prior to their despatch or collection from Company's place of business; and (iii) charge Customer: (A) interest at the rate of 1% per month on the delinquent account and (B) the cost of obtaining judgment or payment to include all reasonable attorney's fees and other costs of issuing proceedings or otherwise pursuing a debt recovery procedure.
- 4.7. CIT/Commercial Service Inc. (P.O. Box 31307 Charlotte, N.C 28231) serves as Company's factors. They will open an account for Customer provided Customer is satisfactory rated with a recognized credit agency. If Customer is not so rated, Customer may still apply to open an account by submitting Customer's name, address of its bank and trade references to CIT. Customer should allow for delay in credit checks. In addition, Company will process orders upon receipt of ½ deposit, balance required before shipment. Credit application

is available at [www.jackcartwright.com](http://www.jackcartwright.com). Company accepts all major credit cards for payment of orders up to \$5,000 in value. A convenience fee of 3.5% per order will be charged for orders over \$5,000.

#### 5 LIMITED WARRANTY.

- 5.1. Company warrants that the Goods supplied hereunder shall be free from material defects in materials and workmanship under normal single shift use and service for a period of five (5) years from the date of shipment ("Warranty Period") for sales made to the original end user. Notwithstanding the foregoing, Company's warranties shall not extend to: (i) any defect arising from normal wear and tear, damage resulting from transportation, wilful damage, negligence, accident, abnormal working conditions, failure to follow Company's instructions (whether oral or in writing), misuse or alteration or repair of the Goods without Company's approval; (ii) any Goods if the total price for the Goods has not been paid by the due date for payment; (iii) any Goods manufactured or appropriated to the Contract in accordance with any design, specification, instruction or recommendation made to Company by Customer; (iv) in respect of any type of defect, damage or wear specifically excluded by Company by notice in writing; (v) if Customer makes any further use of the Goods after giving notice in accordance with this Section 5; and (vi) for any defects or claims relating to the fabric, leather, vinyl and any other covering materials used for the Goods. Any claim by Customer for any breach of Company's limited express warranty with respect to any Goods must be made by Customer to Company in writing during the Warranty Period, or such claim shall conclusively be deemed to have been waived by Customer.
- 5.2. In the event of a claim by Customer under Company's express limited warranty, Customer must notify Company of the claim and obtain Company's written consent and shipping instructions prior to returning the Goods. Unauthorized returns will not be accepted and will be returned freight collect. Customer must return the Goods to Company together with written notification of such alleged defect for inspection by Company, after which, Company shall at its option and within a reasonable time: (i) repair or replace such Goods free of charge to Customer (including all costs of transportation of any Goods or materials to and from Customer for that purpose); or (ii) issue a credit to Customer in respect of the whole or part of the Contract price of such Goods as appropriate having taken back such Goods or materials relating to such Goods, provided that the liability of Company under this Section 5 shall in no event exceed the purchase price of such Goods and performance of any one of the above options shall constitute an entire discharge of Company's liability under this express limited warranty.
- 5.3. COMPANY MAKES NO OTHER EXPRESS WARRANTIES OTHER THAN THOSE EXPRESSLY SET FORTH IN THESE TERMS AND MAKES NO IMPLIED WARRANTIES, WHETHER AS TO MERCHANTABILITY, FITNESS FOR A PARTICULAR PURPOSE OR OTHERWISE, WITH RESPECT TO THE PRODUCTS WHICH ARE THE SUBJECT OF THIS CONTRACT AND COMPANY EXPRESSLY

DISCLAIMS ALL SUCH OTHER WARRANTIES. NO VERBAL STATEMENT BY COMPANY'S AGENTS OR EMPLOYEES, MADE BEFORE OR AFTER THE EXECUTION OF THIS CONTRACT and NO SAMPLES, DRAWINGS, DESCRIPTIVE MATTER, ADVERTISING, OR ANY DESCRIPTIONS OR ILLUSTRATIONS CONTAINED IN ANY COMPANY CATALOGUE OR BROCHURE SUBMITTED BY COMPANY OR PROVIDED TO CUSTOMER, SHALL BE CONSTRUED AS BEING A PART OF THIS CONTRACT OR CREATING ANY WARRANTIES, EXPRESS OR IMPLIED.

5.4. All Goods are produced to price list specifications unless otherwise agreed in writing. All dimensions are approximate. Company reserves the right to amend the specifications or make modifications of the Goods without prior notice or if required by any applicable statutory or regulatory requirements and such changes shall not affect the validity of the Contract.

## 6 LIMITATION OF LIABILITY.

6.1. In all events, Company's total liability in contract, tort (including negligence or breach of statutory duty), misrepresentation or otherwise, arising in connection with the performance or contemplated performance of this Contract shall be limited to the price of the Goods at issue.

6.2. Company shall not be liable to Customer for any loss of profit or other economic loss (direct or indirect), indirect or consequential loss or damage, costs, expenses or other claims for consequential compensation whatsoever (howsoever caused) or loss or damage (contractual, tortious, breach of statutory duty or otherwise) which arises out of or in connection with the Contract, or for any liability incurred by Customer to any other person for any economic loss, claim for damages or awards howsoever arising from the Goods or otherwise.

6.3. To the extent that the Goods are to be manufactured in accordance with a specification supplied by Customer, Customer shall indemnify Company against all liabilities, costs, expenses, damages and losses (including any direct, indirect or consequential losses, loss of profit, loss of reputation and all interest, penalties and reasonable attorneys' fees, costs and expenses) suffered or incurred by Company in connection with any claim made against Company for actual or alleged infringement of a third party's intellectual property rights arising out of or in connection with Company's use of the specification

## 7 COVERING MATERIALS AND CUSTOMER MATERIALS.

7.1. Yardage requirement is based on 54" wide plain covering material and must be increased if less than 54", if the pattern requires matching and /or has a nap or pile. Leather requirements are based on formula of 18 square feet of leather equals one linear yard of 54" wide over material. Small hides may require additional square footage.

7.2. Special instructions for handling materials (pattern,

direction of stripe, right side of reversible fabric, etc.) must be submitted by Customer in writing before fabric is delivered. In the absence of special instructions, Company reserves the right to use its own judgement. Furniture specified using multi-fabric applications or contrasting welts will be up charged. Contact factory.

7.3. Company reserves the right to reject any covering which, in our opinion, is unsuitable for upholstery purposes. However, in no instance shall Company be held responsible for unsatisfactory results due to use of covering unsuitable for our manufacturing methods.

7.4. Inasmuch as mills and tanneries do not guarantee their products, Company shall not be held responsible for differences in color or tone between covering material supplied and samples from which selection has been made. Nor shall Company be held responsible for wear, fading, puddling, stretching or performance of any covering material whether supplied by ourselves or Customer.

7.5. Company will not be responsible for errors caused by Customer not supplying Company with sample cuttings attached to their order giving full identification of covering material (name of supplier, covering name, number and color) for identification purposes and advising Company of model number and quantity to which each cover is to be applied.

7.6. Customer's own material that is shipped freight collect will be refused. A service charge will be applied for the return of unusable Customer own material. Contact factory. Outside of Customer's own material packages are to be marked with Company's acknowledgment number, Customer's firm name, job and order number, Company model number and quantity.

### Ship freight prepaid to:

Cartwright, Incorporated

2014 Chestnut Street

High Point, North Carolina 27262

## 8 SUBCONTRACTING, ASSIGNMENT AND THIRD PARTY RIGHTS.

8.1. Customer shall not be entitled to assign, charge, subcontract or transfer the Contract or any part of it without the prior written consent of Company. Company may assign, charge, subcontract or transfer the Contract or any part of it to any person.

## 9 FORCE MAJEURE.

9.1. Company reserves the right to suspend or cancel the Contract in whole or in part (without liability to Customer) if it is prevented from or delayed in the carrying on of its business and its obligations under the Contract due to any circumstances beyond the reasonable control of Company including, without limitation, acts of God, flood, lightning, war, revolution, act of terrorism, riot or civil commotion, strikes, lock outs or other industrial action (whether of the affected party's own employees or others), failure of supplies of power,

fuel, transport, equipment, raw materials or other goods or services ("Force Majeure Event") provided that, if the event of force majeure continues for a continuous period in excess of 3 months, Customer shall be entitled to give 2 month's prior notice in writing to Company to terminate the Contract.

## **10 BREACH OF CONTRACT OR INSOLVENCY.**

- 10.1. Without limiting its other rights or remedies, Company may immediately suspend performance of the Contract, cancel any outstanding delivery of the Goods, stop any Goods in transit or by notice in writing to Customer terminate the Contract without liability to Company: (a) if Company shall not have received a payment from Customer, when due and such failure of payment shall remain uncured for a period of fourteen (14) days; (b) if Customer shall fail to perform any other obligation under the Contract and such failure is not excused or cured within fourteen (14) days after written notice thereof; (c) Customer files a petition in bankruptcy or otherwise commences or acquiesces in the commencement of a proceeding under any bankruptcy, insolvency, reorganization or similar law, or makes an assignment for the benefit of creditors, or has a bankruptcy petition filed against it which is not withdrawn or dismissed within thirty (30) days after filing, or has a liquidator, administrator, custodian, receiver, trustee, conservator or similar official appointed with respect to it or any substantial portion of its assets or otherwise becomes insolvent; (d) Customer suspends, threatens to suspend, ceases or threatens to cease to carry on all or a substantial part of its business; or (e) Customer's financial position deteriorates to such an extent that in Company's opinion Customer's capability to adequately fulfil its obligations under the Contract has been placed in jeopardy.
- 10.2. Notwithstanding any such termination or suspension in accordance with Section 10.1 Customer shall immediately pay Company for all Goods delivered up to and including the date of suspension or termination together with any interest.
- 10.3. Termination of the Contract for any reason shall be without prejudice to the rights and remedies of either party which may have accrued up to termination.
- 10.4. Conditions which expressly or by implication survive termination of the Contract shall continue in full force and effect.

## **11 NON-SOLICITATION.**

- 11.1 Customer agrees that, during the term of the Contract and for the period of 6 months after its termination, it shall not without the prior written consent of Company: (i) make any offer of employment or enter into any discussion or negotiations with a view to making any offer of employment to any person employed by Company at any time during the term of the Contract; and/or (ii) solicit or attempt to solicit services from any employee on their own account or entice or attempt to entice any employee away from Company.

## **12 NOTICES.**

- 12.1 All notices, consents, communications or transmittals under the Contract shall be in writing and shall be deemed received on the day of delivery if delivered by hand, by nationally

recognized overnight courier or delivery service (with written confirmation of the completed delivery) or by facsimile (with written confirmation of the completed transmittal); or within three (3) business days if mailed by United States mail as certified or registered mail with return receipt, postage prepaid, addressed to the party to whom such notice is given at the address of such party stated in the Contract.

## **13 GENERAL.**

- 13.1 Any intellectual property rights created by Company in the course of the performance of the Contract or otherwise in the manufacture of the Goods shall remain Company's property. Nothing in the Contract shall be deemed to have given Customer a licence or any other right to use any of the intellectual property rights of Company.
- 13.2 Both Company and Customer shall each keep confidential and shall not, without the prior written agreement of the other, disclose to any third party or otherwise make public the terms of the Contract or any other confidential or sensitive information of the other party.
- 13.3 The waiver by either party of any breach of the Contract shall not prevent the subsequent enforcement of that breach and shall not be deemed to be a waiver of any subsequent breach of that or any other provision.
- 13.4 If any condition is held to be invalid for any reason, such invalidity will not affect the rest of the Contract which will remain valid and enforceable in all respects.
- 13.5 The Contract sets out the entire agreement and understanding between Customer and Company in connection with the sale of the Goods and shall supersede and replace all documentation previously issued by Company purporting to set out its terms and conditions of sale of the Goods.
- 13.6 The United Nations Convention on Contracts for the International Sale of Goods shall not apply to this Contract.

## **14 GOVERNING LAW AND JURISDICTION.**

- 14.1 This Contract shall be governed by and be construed in all respects in accordance with the laws of the State of North Carolina, United States of America and all disputes or claims arising out of or relating to this Contract shall be subject to the exclusive jurisdiction and venue of the state and federal courts located in Guilford County, North Carolina, United States of America.





customerservice@bossdesign.com

---

**Headquarters**

**USA**  
North American HQ  
2014 Chestnut Street  
High Point N.C. 27262  
T: +1 844-353-7834

---

**Showrooms**

**UK - London**  
7 Clerkenwell Road  
London  
EC1M 5PA  
T: +44 (0)20 7253 0364

**Germany - Frankfurt**  
Baseler Str. 10,  
60329, Frankfurt am Main  
Germany  
T: +46 69 2695 8420

**UAE - Dubai**  
Design House  
Al Noor St. Al Sufouh 1  
PO Box 117088 Dubai  
T: +971 (0)443 788 99

**UK**  
Boss Drive Dudley  
West Midlands  
DY2 8SZ  
T: +44 (0)1384 455 570

**Manchester**  
The Lightwell  
25-27 Booth Street  
Manchester M2 4AF  
T: +44 (0)161 711 0585

**USA - Chicago**  
222 Merchandise Mart  
Plaza, Suite 359  
Chicago IL 60654  
T: +1 844-353-7834